

# W Series

Color Screen Fingerprint & Card  
Time Attendance and Access Control

## Quick Guide V1.1

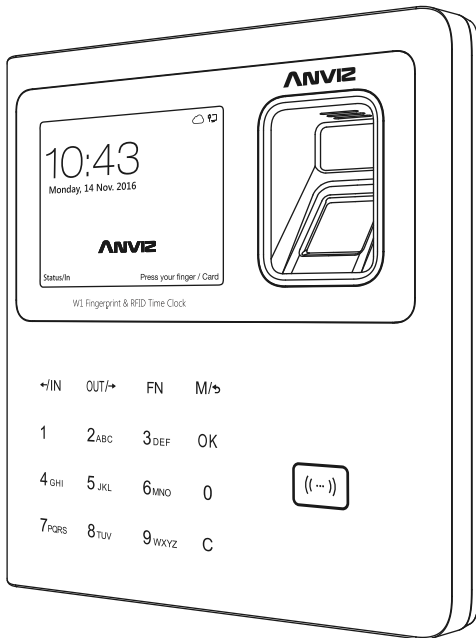

W 1

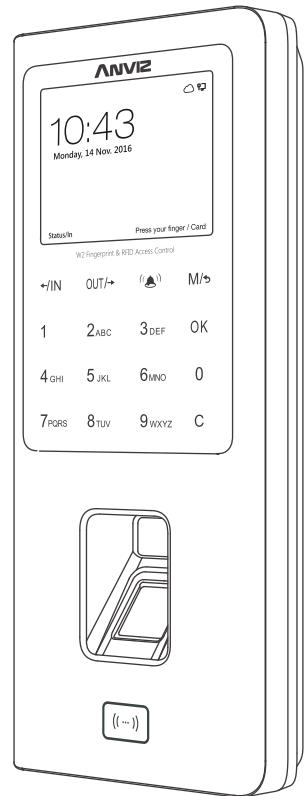

W 2

## W1 & W2 Features

- \* Standard 2.8-inch TFT LCD, 512MB Flash, industrial high speed CPU
- \* Touch keypad & touch active sensor
- \* Identification mode: Fingerprint, Password, Card (optional)
- \* Cloud management system support
- \* Support webserver: basic setting, personnel inquiry and management, records inquiry
- \* DDNS: Support dynamic domain name server which offers a persistent domain name for non-static IP devices
- \* Support TCP/IP network communication, the access control data and events will push to the access control management software by real time.
- \* With 32 customize access control time zone and 16 permission groups make access control more easy (W2 access control)
- \* Communication: TCP/IP, Mini USB, USB Host, RS485 (RS485 is for W2 access control)
- \* W2 In/Out: 1 relay output, wiegand input/output, door switch, door sensor, tamper alarm
- \* Registration capacity: 3000 Fingerprints and 100000 Records

## Installation Guide

### 1. What's in the package?

#### 1 Device

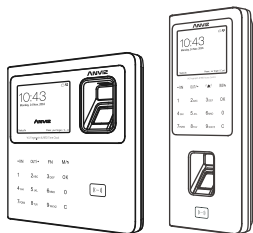

W1

or

W2

\*Card is optional

#### 2 Instruction Package

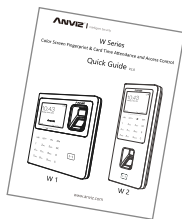

#### 3 Accessory Package

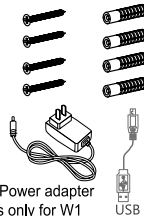

\*Power adapter is only for W1

USB



\*Two extended function connector cables are only for W2

### 2. Mount the Device to Wall

- \* Install the mounting panel on th wall
- \* Plug in the Ethernet cable, charger or extended function connector cable
- \* Slide the W1 or W2 down onto the panel and secure with the screw on the bottom of device

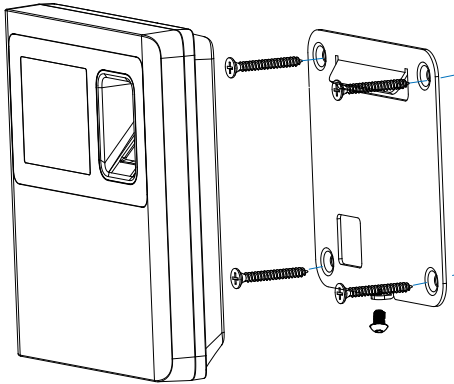

W 1

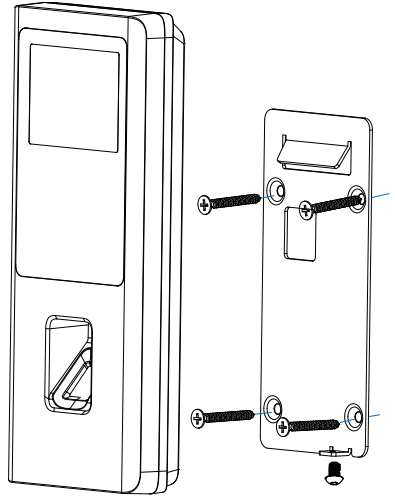

W 2

## Wiring Instruction

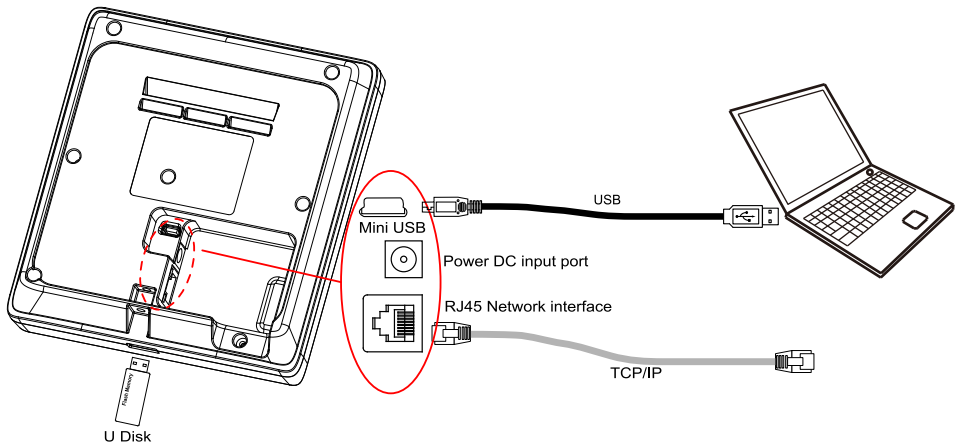

W 1

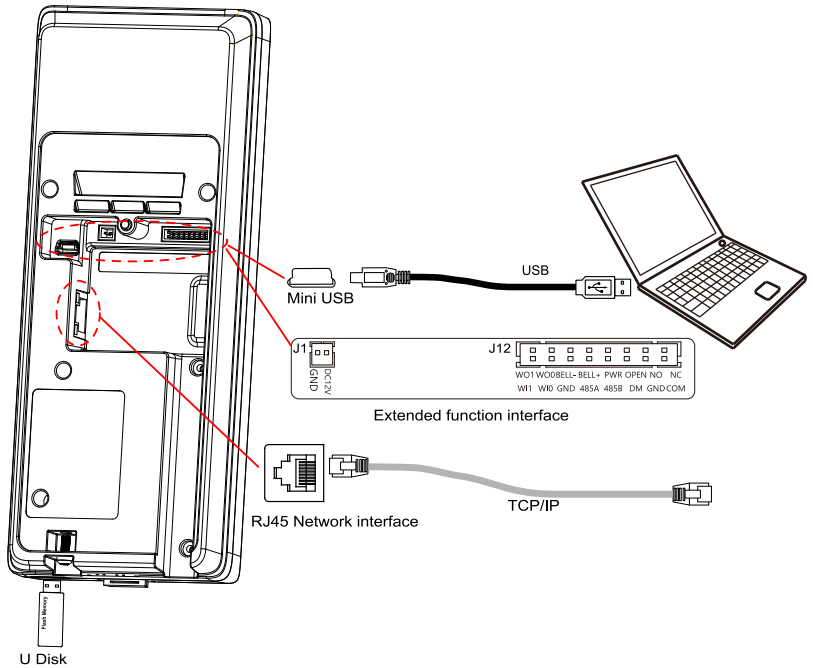

J12 Extended function interface:

Function	Wiegand 26 Output		Active doorbell		Passive doorbell	Exit Button	Relay Output	
	Wiegand DATA1 Output	Wiegand DATA0 Output	Door Bell-	Door Bell+			NO	NC
No.	②	④	⑥	⑧	⑩	⑫	⑭	⑯
Cable Color	White	Green	Gray	Red	Gray	Yellow	Blue	Brown
Function	Wiegand 26 Input		RS485			Door Magnetic		COM
	Wiegand DATA1 Input	Wiegand DATA0 Input	GND	RS485A	RS485B	Door Magnetic	GND	
No.	①	③	⑤	⑦	⑨	⑪	⑬	⑮
Cable Color	Gray	Gray	Black	Gray	Gray	Purple	Black	Orange



Important notice: Please follow the wiring diagram as it is displayed. Damaged products diagram as it is displayed. Damaged products due to improper wiring are not covered under the product warranty.

## W2 & Switching Power Supply



Switch Power Supply

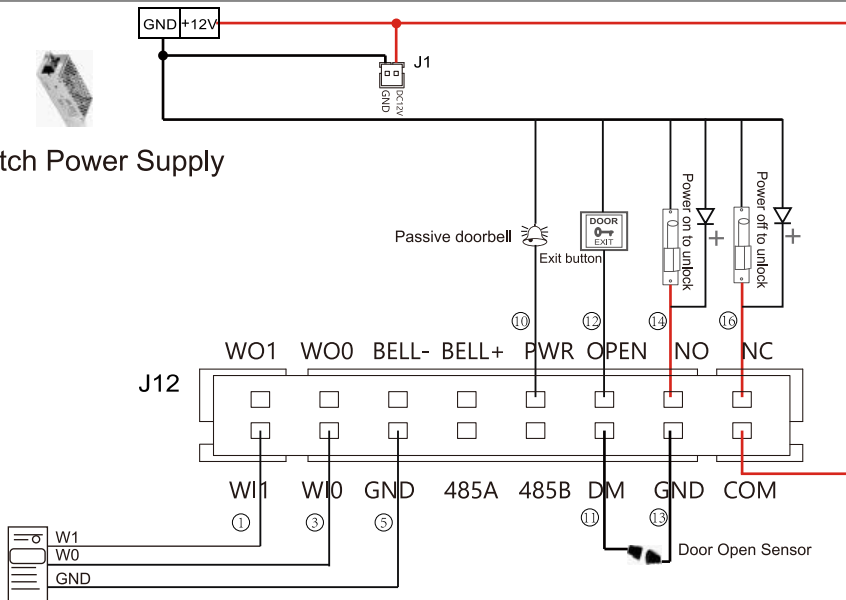

Wiegand Card Reader

## W2 & Anviz SC011

SC011 can work with W2 by Anviz encrypt Wiegand code authorized to set up a distributed access control system. Wiegand mode must be set to 'AnvizWiegand' by PC software. You can buy SC011 from our sales.

Switch Power Supply

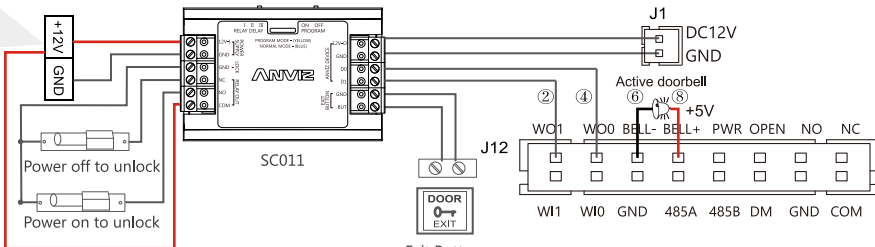

Exit Button

### Anviz Wiegand date output format:

ALL registered users output devices' last eight serial number.  
 (For example, SN of one device is 1050000014470004, then Anviz Wiegand output 14470004.)

### Wiegand 26 date output format (W2 & other access control):

Card user: Output card number.(Decimal)

Fingerprint user: Output ID number.

## W2 & Access Control Power Supply

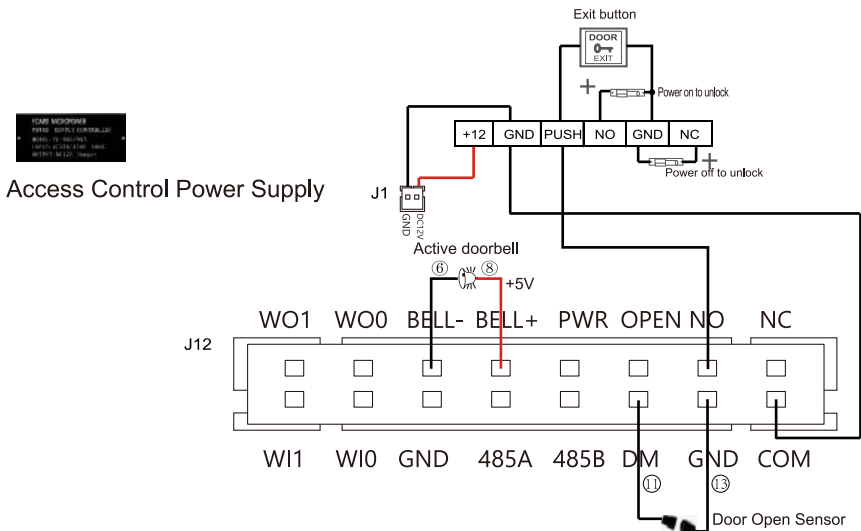

Have a question? Please feel free to send emails to [support@anziv.com](mailto:support@anziv.com) to get support.

## Basic Operation

### 1. Turn on the Device



\* 0/12345 is the default Admin ID and password. You can change to your own the password or set other user as Admin later.

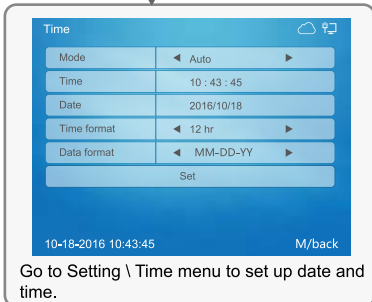

### 2. Add Users to Device

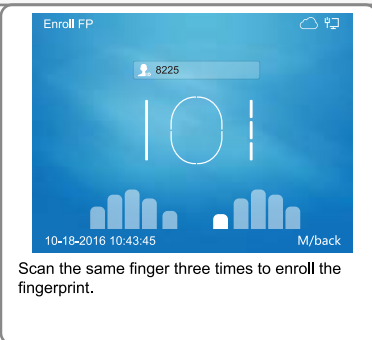
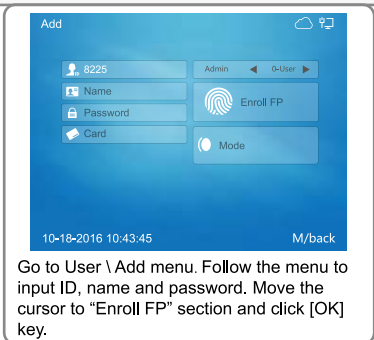

\* RFID Card is the optional feature. If you have the card option and want to enroll the card, use the up & down key to move the cursor to card number field. Swipe the card in the field of card module. The card number will be displayed.

### 3. Input Characters

When you edit name, you may need to input characters. Here are the steps to input characters:

- \* Using the up and down arrow key to move the cursor to the field.
- \* Press [Fn] key on the keypad, a character input window "Aa" will be displayed on the bottom of the screen. Then press the number/letter key. A second window will appear and you can select the letter by number key .
- \* Press [IN] key on the keypad, the character input window will toggled between "Aa", "123", ",.!?" and "拼". You can select the window to input the letter, number or special symbols.

### 4. Verity the Fingerprint

#### ■ Correct method :

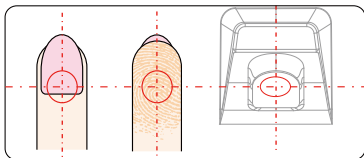

Place finger in the center of the sensor.

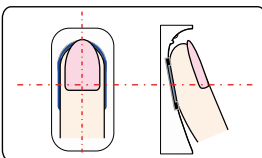

Place finger flatly and smoothly on the sensor.

#### ■ Incorrect method :

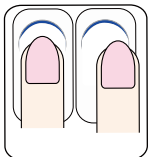

Finger not placed on the center of the sensor



Finger placed inclined

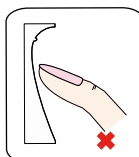

Use of fingertip

#### **Note:**

1. It is better for each user to register two finger prints in case of one finger can't work.
2. Place finger flat and make sure the center of the finger is on the center of scanner window and press a little hard on scanner, so it can scan as large finger area as possible to extract enough minutia.
3. Keep the angle and direction of finger the same each time placing on scanner.
4. If your finger has sweat or water, please dry it first and then register the finger.
5. If your finger is too dry, make it a little wet or touch the forehead to increase the wetness of the finger, press a little hard on scanner. (The dry finger can cause the finger image not coming out clear enough.)
6. Avoid the callus, peeling, or injury of the finger to ensure the register and identification successful.
7. You can register the thumb first, and then index finger or middle finger to increase the precision.

### 5. Setup the Device Communication

- \* Go to Network \ Internet menu to select Ethernet or close Ethernet
- \* Go to Network \ Communication Mode to select Server or Client mode , RS485
- \* Go to Network menu to setup Ethernet parameter according to your network settings
- \* Ping the IP address of Device from the management computer. Make sure the Ping is successful



# Поставщик систем безопасности TELECAMERA.RU Ethernet Settings

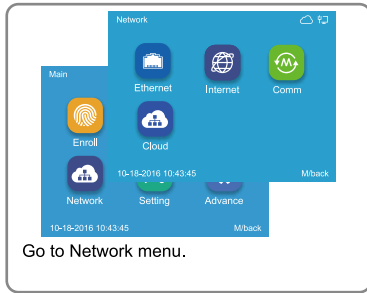

Go to Network menu.

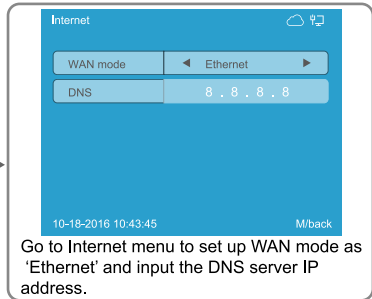

Go to Internet menu to set up WAN mode as 'Ethernet' and input the DNS server IP address.

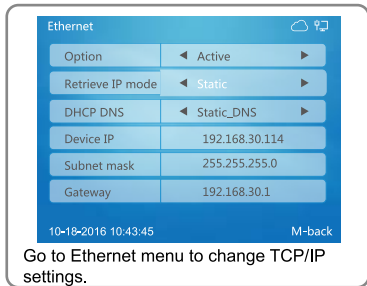

Go to Ethernet menu to change TCP/IP settings.

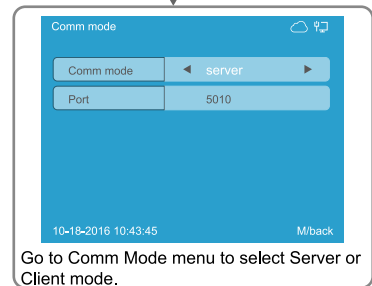

Go to Comm Mode menu to select Server or Client mode.

## Working with Management Software

### 1. Install the Management Software on Computer

Put the CD in the management computer. The installation program will run automatically.

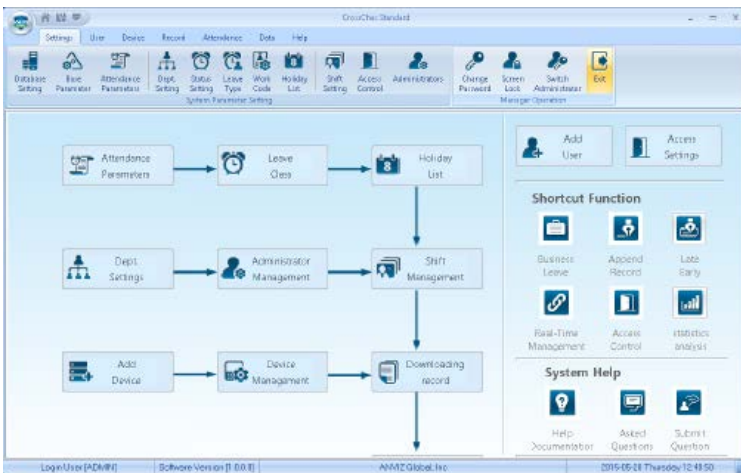

How to connect the Device with Software?

## 1st Method: Mini USB

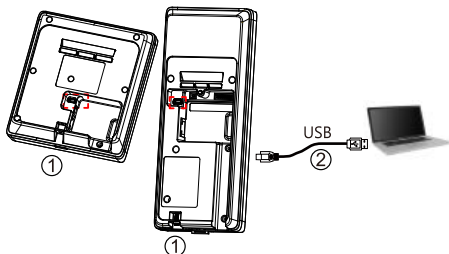

- ① Loose the screw on the bottom of device, then pull up the front case, separate from back panel
- ② Connect USB cable between with device and PC which has installed software

## 2nd Method: Connect to Network

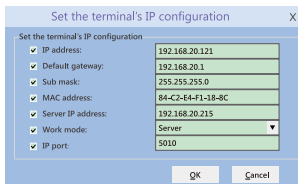
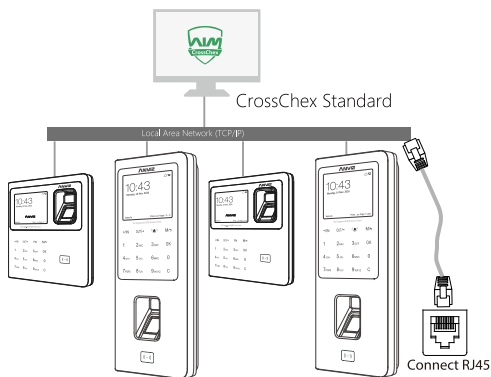

Right click on the device icon and choose 'Set the IP configuration' to set correct network environment parameters such as above window.

## 2. Enable Communication between Device and the Management Software CrossChex

- \* Turn on management software CrossChex
- \* Go to Device tab. Search and Add the W1 or W2 to management software CrossChex
- \* Click Synchronize Time button to communicate with Device. If Synchronize is successful, the device icon will turn to blue

## 3. The Management Software CrossChex Features

- \* Device \ Backup User: Download user info from Device to CrossChex
- \* Device \ Download Records: Download records from Device to CrossChex
- \* User \ Modify: Edit name or other user info. Then click "Upload User" to Upload user info to device
- \* Record \ Search: Search and view the records
- \* Attendance: Calculate, Search results and Generate reports
- \* Data \ Backup Database: Backup Database
- \* Setting \ Shift: Set up Time Table and Scheduling
- \* Device \ Device Parameter: Set up device, Clear records on Device or Reset Device to factory settings