

Network Video Decoder User's Manual

V3.7.0

Table of Contents

1	OVERVIEW	1
1.1	General Introduction.....	1
1.2	Features.....	1
2	FRONT PANEL/REAR PANEL/INSTALLATION.....	8
2.1	Check Unpacked Device	8
2.2	Front panel	8
2.2.1	1/4-Channel 4K High Definition&1-Channel 4K (H.265) 4K High Definition Series..	8
2.2.2	9-Channel 4K High Definition (With 4 Input Ports) Series / 9-Channel 4K High Definition Series /9-Channel High Definition Series/16-Channel High Definition Series.....	9
2.2.3	12-Channel 4K High Definition Series/12-Channel 4K High Definition (With 4 Input Ports) Series/ 15-Channel 4K High Definition Series/15-Channel 4K High Definition (With 4 Input Ports) Series/ 18-Channel 4K High Definition Series/18-Channel 4K High Definition (With 4 Input Ports) Series/ 21-Channel 4K High Definition Series/21-Channel 4K High Definition (With 4 Input Ports) Series	10
2.3	Rear Panel.....	11
2.3.1	1-Channel 4K High Definition/1-Channel 4K (H.265) High Definition Series.....	11
2.3.2	4-Channel 4K High Definition Series	12
2.3.3	9-Channel 4K High Definition (With 4 Input Ports) Series	12
2.3.4	9-Channel 4K High Definition Series	13
2.3.5	9-Channel High Definition Series	14
2.3.6	16-Channel High Definition Series	14
2.3.7	12-Channel 4K High Definition Series/12-Channel 4K High Definition (With 4 Input Ports) Series/ 15-Channel 4K High Definition Series/15-Channel 4K High Definition (With 4 Input Ports) Series/ 18-Channel 4K High Definition Series/18-Channel 4K High Definition (With 4 Input Ports) Series/ 21-Channel 4K High Definition Series/21-Channel 4K High Definition (With 4 Input Ports) Series	15
2.4	Connection	18

2.4.1	General Connection.....	18
2.4.2	Audio/Video Connection	19
2.4.3	Audio Talk Input Connection.....	19
2.4.4	Video Output Device and Connection.....	19
2.4.5	Audio Output.....	20
3	OPERATION.....	21
3.1	Boot up.....	21
3.2	Shut down.....	21
3.3	Network Connection.....	21
3.4	Login.....	21
3.4.1	4-channel high definition series/16-channel high definition series/1-channel 4K high definition series/1-channel 4K(H.265) high definition series/4-channel 4K high definition series/12-channel 4K high definition series/12-channel 4K high definition (with 4 input ports) series/15-channel 4K high definition series/15-channel 4K high definition (with 4 input ports) series/18-channel 4K high definition series/18-channel 4K high definition (with 4 input ports) series/21-channel 4K high definition series/21-channel 4K high definition (with 4 input ports) series	22
3.4.2	9-channel 4K high definition series/9-channel 4K high definition (with 4 input ports) series	25
3.5	WEB Live Interface.....	26
3.5.1	System menu.....	26
3.5.2	Screen No.	26
3.5.3	Splicing wall.....	27
3.5.4	Bidirectional talk.....	27
3.5.5	Connected front-end device list.....	28
3.5.6	Add/delete device	29
3.5.7	Playback.....	29
3.5.8	Window split.....	29
3.5.9	Fisheye.....	31
3.5.10	TV adjustment/screens	34
3.5.11	Close/Open full-screen monitor	36
3.5.12	Refresh	36
3.5.13	Schemes manager.....	36

3.5.14	Roam	36
3.6	Video Wall Splicing (Display Pane) Function	37
3.6.1	Configuring Splicing Screen.....	37
3.6.2	Configuring Step	40
3.6.3	Cancel splicing wall	41
3.6.4	Info Manager	41
3.6.5	Background Setup	41
3.7	Add /Remove Front-end Device	42
3.7.1	Add Device.....	42
3.7.2	Delete Device	43
3.8	Decode Channel Setup	43
3.9	Playback	44
3.9.1	Playback by File.....	44
3.9.2	Playback by Time	47
3.10	Scheme Tour.....	47
3.10.1	Add New Scheme	47
3.10.2	Scheme Manager.....	48
3.10.3	Replace Original Scheme	50
3.11	Decoder.....	50
3.11.1	Decode Tour.....	50
3.11.2	Decode Info.....	54
3.11.3	Decode Strategy	55
3.11.4	Screen No. Overlay	57
3.11.5	Output Options	57
3.11.6	Background Color	58
3.11.7	Split Line.....	58
3.11.8	The Last Frame	59
3.11.9	Regular Line.....	59
3.12	Setting	60
3.12.1	General.....	60
3.12.2	Network	61
3.12.3	RS232.....	65

3.12.4	Alarm.....	71
3.12.5	Resolution	75
3.12.6	Signal Adjustment.....	76
3.12.7	Background.....	78
3.12.8	Account.....	78
3.12.9	IP Filter	83
3.12.10	Remote Device.....	85
3.12.11	Fan Control	87
3.13	Maintain.....	88
3.13.1	Version.....	88
3.13.2	Log	88
3.13.3	Security.....	89
3.13.4	Card Info.....	90
3.13.5	System Info	90
3.13.6	Sniffer.....	91
3.13.7	Default and Backup	95
3.13.8	Auto Maintenance	96
3.13.9	Connection mode.....	96
3.14	Log out.....	97
4	LOCAL GUI OPERATION.....	98
4.1	Boot up.....	98
4.2	About Interface.....	98
4.2.1	Main Interface.....	99
4.2.2	Device Tree	100
4.2.3	Shortcut Menu	101
4.3	GUI Basic Operation.....	103
4.3.1	Main Menu	103
4.3.2	Remote Device.....	114
4.3.3	Network	114
4.3.4	Close.....	114
5	ALARM INPUT AND OUTPUT	116

5.1	Alarm Ports.....	116
5.1.1	1-Channel 4K High Definition Series/1-Channel 4K (H.265) High Definition Series 116	
5.1.2	4-Channel 4K High Definition Series	117
5.1.3	9-Channel 4K High Definition Series/9-Channel 4K High Definition (With 4 Input Ports) Series/9-Channel High Definition Series	117
5.1.4	12-Channel 4K High Definition Series/12-Channel 4K High Definition (With 4 Input Ports) Series/15-Channel 4K High Definition Series/15-Channel 4K High Definition (With 4 Input Ports) Series/18-Channel 4K High Definition Series/18-Channel 4K High Definition (With 4 Input Ports) Series/21-Channel 4K High Definition Series/21-Channel 4K High Definition (With 4 Input Ports) Series	117
5.2	Alarm Input Port Notice	118
5.3	Alarm Output Port.....	119
5.4	Alarm Output Relay Specifications	120
6	SPECIFICATIONS.....	121
6.1	1-channel 4K High Definition /1-channel 4K (H.265) High Definition Series.....	121
6.2	4-channel 4K High Definition Series.....	122
6.3	9-channel 4K high definition (with 4 input ports) series/9-channel 4K high definition series	123
6.4	9/16-channel High Definition Series	124
6.5	12/15/18/21-channel 4K High Definition Series	126

Welcome

Thank you for purchasing our product!

This user's manual is designed to be a reference tool for the operation of your system.

Here you can find information about these series products' features and functions.

Before installation and operation please read the following safeguards and warnings carefully!

Cybersecurity Recommendations

Cybersecurity Recommendations

Mandatory actions to be taken towards cybersecurity

1. Change Passwords and Use Strong Passwords:

The number one reason systems get “hacked” is due to having weak or default passwords. It is recommended to change default passwords immediately and choose a strong password whenever possible. A strong password should be made up of at least 8 characters and a combination of special characters, numbers, and upper and lower case letters.

2. Update Firmware

As is standard procedure in the tech-industry, we recommend keeping NVR, DVR, and IP camera firmware up-to-date to ensure the system is current with the latest security patches and fixes.

“Nice to have” recommendations to improve your network security

1. Change Passwords Regularly

Regularly change the credentials to your devices to help ensure that only authorized users are able to access the system.

2. Change Default HTTP and TCP Ports:

- Change default HTTP and TCP ports for systems. These are the two ports used to communicate and to view video feeds remotely.
- These ports can be changed to any set of numbers between 1025-65535. Avoiding the default ports reduces the risk of outsiders being able to guess which ports you are using.

3. Enable HTTPS/SSL:

Set up an SSL Certificate to enable HTTPS. This will encrypt all communication between your devices and recorder.

4. Enable IP Filter:

Enabling your IP filter will prevent everyone, except those with specified IP addresses, from accessing the system.

5. Change ONVIF Password:

On older IP Camera firmware, the ONVIF password does not change when you change the system’s credentials. You will need to either update the camera’s firmware to the latest revision or manually change the ONVIF password.

6. Forward Only Ports You Need:

- Only forward the HTTP and TCP ports that you need to use. Do not forward a huge range of numbers to the device. Do not DMZ the device's IP address.
- You do not need to forward any ports for individual cameras if they are all connected to a recorder on site; just the NVR is needed.

7. Disable Auto-Login on SmartPSS:

Those using SmartPSS to view their system and on a computer that is used by multiple people should disable auto-login. This adds a layer of security to prevent users without the appropriate credentials from accessing the system.

8. Use a Different Username and Password for SmartPSS:

In the event that your social media, bank, email, etc. account is compromised, you would not want someone collecting those passwords and trying them out on your video surveillance system. Using a different username and password for your security system will make it more difficult for someone to guess their way into your system.

9. Limit Features of Guest Accounts:

If your system is set up for multiple users, ensure that each user only has rights to features and functions they need to use to perform their job.

10. UPnP:

- UPnP will automatically try to forward ports in your router or modem. Normally this would be a good thing. However, if your system automatically forwards the ports and you leave the credentials defaulted, you may end up with unwanted visitors.
- If you manually forwarded the HTTP and TCP ports in your router/modem, this feature should be turned off regardless. Disabling UPnP is recommended when the function is not used in real applications.

11. SNMP:

Disable SNMP if you are not using it. If you are using SNMP, you should do so only temporarily, for tracing and testing purposes only.

12. Multicast:

Multicast is used to share video streams between two recorders. Currently there are no known issues involving Multicast, but if you are not using this feature, deactivation can enhance your network security.

13. Check the Log:

If you suspect that someone has gained unauthorized access to your system, you can check the system log. The system log will show you which IP addresses were used to login to your system and what was accessed.

14. Physically Lock Down the Device:

Ideally, you want to prevent any unauthorized physical access to your system. The best way to achieve this is to install the recorder in a lockbox, locking server rack, or in a room that is behind a lock and key.

15. Connect IP Cameras to the PoE Ports on the Back of an NVR:

Cameras connected to the PoE ports on the back of an NVR are isolated from the outside world and cannot be accessed directly.

16. Isolate NVR and IP Camera Network

The network your NVR and IP camera resides on should not be the same network as your public computer network. This will prevent any visitors or unwanted guests from getting access to the same network the security system needs in order to function properly.

Important Safeguard and Warning

1 . Electrical safety

- All installation and operation here should conform to your local electrical safety codes.
- The product must be grounded to reduce the risk of electric shock.
- We assume no liability or responsibility for all the fires or electrical shock caused by improper handling or installation.
- Please use three-pin power socket (with GND).
- This device is to be connected only to the unit whose power feeding meets the requirements for SELV (Safety Extra Low Voltage) and complies with Limited Power Source according to IEC 60950-1.
- We are not liable for any problems caused by unauthorized modifications or attempted repair.

2 . Installation

- Do not apply power to the device before completing installation.
- Do not put object on the device.
- All the examination and repair work should be done by the qualified service engineers.

3 . Environment

- This series device should be installed in a cool, dry place away from direct sunlight, inflammable, explosive substances and etc.
- Please guarantee sound ventilation and keep device clean.

4. Accessories









- Be sure to use all the accessories recommended by manufacturer.
- Before installation, please open the package and check all the components are included.
- Contact your local retailer ASAP if something is broken in your package.



DANGER

RISK OF EXPLOSION IF BATTERY IS REPLACED BY AN INCORRECT TYPE.

DISPOSE OF USED BATTERIES ACCORDING TO THE INSTRUCTIONS.**Safety Instruction**

Icon	Note
 DANGER	Indicates a hazard with a high level of risk, which if not avoided, will result in death or serious injury.
 WARNING	Indicates a hazard with a middle or low level of risk, which if not avoided, could result in personnel slightly or middle injury.
 CAUTION	Indicates a potentially hazardous situation, which if not avoided, could result in device damage, data loss, performance degradation, or unexpected results.
 Anti-static	Indicates it is the static sensitive device.
 Electric shock risk	Indicates presence of dangerous high voltage. There is a risk of electric shock to persons.
 High power laser radiation risk	Indicates presence of high power laser radiation.
 Tips	It is intended to help you to fix a problem or save your time.
 Note	Provides additional information to emphasize or supplement important points of the main text.

Revision History

SN	Version	Contents
1	V3.6.0	Delete 1-channel high definition series/4-channel high definition series product. Add 1-channel 4K (H.265) high definition series product.
2.	V3.7.0	9-channel 4K high definition series security baseline revision.

1 Overview

1.1 General Introduction

These high definition series product is a network audio & video decode device designed and developed for the video network monitor system. It has elegant shape and strong data process capability. It has stable and sound network function and supports all popular encode modes. This series product has sound expansibility and it is easy to maintain and connect.

The decoder effectively guarantees the security, stability, reliability and high performance of the network video surveillance system. At the same time, it greatly reduces the whole system cost.

1.2 Features

Decode

The device decode capability depending on the built-in decode chip performance. Please refer to the following sheet for detailed information.

Model	Decode Output Capability	Output Port	Split Mode
1-channel 4K high definition series	<ul style="list-style-type: none"> ● 16-channel 1080P resolution video decode output ● 12-channel 3MP video decode output ● 7-channel 5MP video decode output ● 6-channel 6MP video decode output ● 4-channel 8MP video decode output ● 1-channel 12MP video decode output ● 1-channel 1080P SVAC video decode output ● 1-channel 1080P H.265 video decode output 	<ul style="list-style-type: none"> ● VGA ● HDMI 	The TV screen supports 1/4/9/16-window display mode.
1-channel 4K(H.265) high definition series	<ul style="list-style-type: none"> ● 64-channel D1 resolution video decode output ● 36-channel 720P resolution video decode output ● 16-channel 1080P resolution video decode output ● 12-channel 3MP video decode output 	<ul style="list-style-type: none"> ● VGA ● HDMI 	The TV screen supports 1/4/9/16/25/36/64-window display mode.

Model	Decode Output Capability	Output Port	Split Mode
	<ul style="list-style-type: none"> ● 9-channel 4MP video decode output ● 8-channel 5MP video decode output ● 6-channel 6MP video decode output ● 4-channel 8MP video decode output ● 3-channel 12MP video decode output 		
4-channel 4K high definition series	<ul style="list-style-type: none"> ● 4-channel 12MP video decode output ● 4-channel 8MP video decode output ● 16-channel 1080P video decode output ● 36-channel 720P video decode output ● 64-channel 960H video decode output ● 4-channel 12MP H.265 video decode output ● 4-channel 8MP H.265 video decode output ● 16-channel 1080P H.265 video decode output ● 36-channel 720P H.265 video decode output ● 64-channel 960H H.265 video decode output 	<ul style="list-style-type: none"> ● VGA ● HDMI ● BNC 	The TV screen supports 1/4/9/16-window display mode.
9-channel 4K high definition (with 4 input ports) series/9-channel 4K high definition series	<ul style="list-style-type: none"> ● 9-channel 12MP resolution video decode output ● 9-channel 8MP resolution video decode output ● 15-channel 5MP resolution video decode output ● 24-channel 3MP resolution video decode output ● 36-channel 1080P resolution video decode output ● 81-channel 720P resolution 	HDMI	The TV screen supports 1/4/9/16-window display mode.

Model	Decode Output Capability	Output Port	Split Mode
	video decode output ● 144-channel 960H resolution video decode output ● 144-channel D1 resolution video decode output ● 9-channel 8MP H.265 resolution video decode output ● 9-channel 12MP H.265 resolution video decode output. ● 15-channel 5MP H.265 resolution video decode output ● 24-channel 3MP H.265 resolution video decode output ● 36-channel 1080P H.265 resolution video decode output ● 81-channel 720P H.265 resolution video decode output. ● 144-channel 960H H.265 resolution video decode output ● 144-channel D1 H.265 resolution video decode output		
9-channel high definition series	● 2-channel 8MP resolution non-real time video decode output ● 8-channel 5MP resolution non-real time video decode output ● 8-channel 3MP resolution non-real time video decode output ● 16-channel 1080P resolution video decode output ● 33-channel 720P resolution video decode output ● 44-channel 960H resolution video decode output ● 48-channel D1 resolution video decode output	● VGA ● HDMI	The first TV screen supports 1/4/9/16-window display mode. The rest TV screens support 1/4-window display mode.

Model	Decode Output Capability	Output Port	Split Mode
16-channel high definition series	<ul style="list-style-type: none"> ● 4-channel 8MP resolution non-real time video decode output ● 16-channel 5MP resolution non-real time video decode output ● 16-channel 3MP resolution non-real time video decode output ● 26-channel 1080P 8 Mbps or 32-channel 1080P 6Mbps resolution video decode output. ● 52-channel 720P resolution video decode output ● 64-channel 960H resolution video decode output ● 64-channel D1 resolution video decode output 	<ul style="list-style-type: none"> ● VGA ● HDMI 	The TV screen supports 1/4-window display mode.
12-channel 4K high definition series/12-channel 4K high definition (with 4 input ports) series	<ul style="list-style-type: none"> ● 12-channel 12MP resolution video decode output ● 12-channel 8MP resolution video decode output ● 20-channel 5MP resolution video decode output ● 32-channel 3MP resolution video decode output ● 48-channel 1080P resolution video decode output ● 108-channel 720P resolution video decode output ● 192-channel 960H resolution video decode output ● 192-channel D1 resolution video decode output 	HDMI	The TV screen supports 1/4/9/16-window display mode.
15-channel 4K high definition series/15-channel 4K high	<ul style="list-style-type: none"> ● 15-channel 12MP resolution video decode output ● 15-channel 8MP resolution video decode output ● 25-channel 5MP resolution video 	HDMI	The TV screen supports 1/4/9/16-window display mode.

Model	Decode Output Capability	Output Port	Split Mode
definition (with 4 input ports) series	decode output <ul style="list-style-type: none"> ● 40-channel 3MP resolution video decode output ● 60-channel 1080P resolution video decode output ● 135-channel 720P resolution video decode output ● 240-channel 960H resolution video decode output ● 240-channel D1 resolution video decode output 		
18-channel 4K high definition series/18-channel 4K high definition (with 4 input ports) series	<ul style="list-style-type: none"> ● 18-channel 12MP resolution video decode output ● 18-channel 8MP resolution video decode output ● 30-channel 5MP resolution video decode output ● 48-channel 3MP resolution video decode output ● 72-channel 1080P resolution video decode output ● 162-channel 720P resolution video decode output ● 288-channel 960H resolution video decode output ● 288-channel D1 resolution video decode output 	HDMI	The TV screen supports 1/4/9/16-window display mode.
21-channel 4K high definition series/21-channel 4K high definition (with 4 input ports) series	<ul style="list-style-type: none"> ● 21-channel 12MP resolution video decode output ● 21-channel 8MP resolution video decode output ● 35-channel 5MP resolution video decode output ● 56-channel 3MP resolution video decode output ● 84-channel 1080P resolution video decode output ● 189-channel 720P resolution video decode output ● 336-channel 960H resolution video decode output ● 336-channel D1 resolution video 	HDMI	The TV screen supports 1/4/9/16-window display mode.

Model	Decode Output Capability	Output Port	Split Mode
	decode output		

- ✧ Real-time stream decode:
Get local real-time bit streams of the encoder and then output.
- ✧ Previous stream decode:
Get the local history bit streams of the encoder and then output.
- ✧ Message feedback:
All applications can accurately get current decoding status.

● Network

- ✧ Support remote control via network,
- ✧ Synchronize system time via NTP service.
- ✧ After you configured the front-end encode device information, decoder can automatically connect to the encode device and then begin work independently and reliably,
- ✧ In transmit mode, decoder can get the random data bit stream from the network server to realize decoding output.

● Output port

- ✧ 1-channel 4K high definition series has one output interface set. It includes one VGA and one HDMI.
- ✧ 1-channel 4K (H.265) high definition series has one output interface set. It includes one VGA and one HDMI.
- ✧ 4-channel 4K high definition series has four output interface sets. One set includes one VGA, one HDMI and one BNC.
- ✧ 9-channel 4K high definition series/ 9-channel 4K high definition (with 4 input ports) series: They include nine HDMI ports respectively.
- ✧ 9-channel high definition series has nine HDMI ports and nine VGA ports.
- ✧ 16-channel high definition series has sixteen HDMI ports and sixteen VGA ports.
- ✧ 12-channel 4K high definition series/12-channel 4K high definition (with 4 input ports) series has twelve HDMI ports
- ✧ 15-channel 4K high definition series/15-channel 4K high definition (with 4 input ports) series has fifteen HDMI ports
- ✧ 18-channel 4K high definition series/18-channel 4K high definition (with 4 input ports) series has eighteen HDMI ports
- ✧ 21-channel 4K high definition series/21-channel 4K high definition (with 4 input ports) series has twenty-one HDMI ports



Note

These series products can realize real-time surveillance via monitor and support alarm tour output and decode tour.

● Input Port

- ✧ 4-channel 4K high definition series has one HDMI input port.
- ✧ 9-channel 4K high definition (with 4 input ports) series has 2 HDMI input ports and 2 DVI-I input ports.
- ✧ 12-channel 4K high definition series/12-channel 4K high definition (with 4 input ports) series has 2 HDMI input ports and 2 DVI-I input ports.
- ✧ 15-channel 4K high definition series/15-channel 4K high definition (with 4 input ports) series has 2 HDMI input ports and 2 DVI-I input ports.
- ✧ 18-channel 4K high definition series/18-channel 4K high definition (with 4 input ports) series has 2 HDMI input ports and 2 DVI-I input ports.
- ✧ 21-channel 4K high definition series/21-channel 4K high definition (with 4 input ports) series has 2 HDMI input ports and 2 DVI-I input ports.

● Alarm

- ✧ External Alarm:
Multiple-channel relay alarm output to activate the peripheral alarm device (such as on-site light control), manual control and activation video output.

Note

The 16-channel high definition series has no external alarm output port and does not support external alarm output port.

- ✧ Decoder Alarm
Prompt current decode status in time.

● COM

- ✧ Support peripheral device control function. The control protocol and connection port can be set at your customized requirements.
- ✧ Support various transparent data transmission such as RS232.

● Account

Each group has one authority setup (support customized setup). The use authority cannot exceed the group authority.

● Aux function

- ✧ Support user to view version information, display device important hardware port information, software version information and etc.
- ✧ Log search function
- ✧ Time Synchronization: Set system time manually or synchronization PC time.
- ✧ Support auto maintain device function, support schedule maintenance.
- ✧ Support various upgrade types such as flash disk, network, and TFTP.

Note

Please refer to the following chapters for function information. Please refer to the actual product for detailed information.

2 Front Panel/Rear Panel/Installation

Note

- All the installation and operations here should conform to your local electric safety rules.
- VGA cable quality and length can affect the video quality. It may result in distorted video, noise, black margin. The video quality may vary even if you are viewing the same video via different VGA cables.

2.1 Check Unpacked Device

When you received the device from the shipping agency, please check whether there is any visible damage. The protective materials used for the package of the device can protect most accidental clashes during transportation. Then you can open the box to check the accessories.

Please check the items in accordance with the list. Finally you can remove the protective film of the device.

The label at the bottom of the box is very important. Usually we need you to present the serial number when we provide the service after sales.

2.2 Front panel





2.2.1 1/4-Channel 4K High Definition&1-Channel 4K (H.265) 4K High Definition Series





The front panel is shown as in Figure 2-1.



Figure 2-1

Please refer to the following sheet for detailed information.

Name	Icon	Function
Power button		Press it for three seconds to boot up or shut down the device. Press it three times within one second, it can clear device configuration.
Power indicator light		The indicator light becomes on when system boots up.
Network indicator light		The indicator light becomes on when abnormal network event occurs (offline, IP conflict and etc.)
USB port		Connect to external USB device.

Name	Icon	Function
Alarm indicator light		The light becomes on when there is an alarm.
HDD indicator light		N/A
IR receiver		N/A
Output indicator light		It is to display output port working mode. <ul style="list-style-type: none"> For 1-channel 4K high definition series and 1-channel 4K (H.265) high definition series, only the first indicator light is effective. For 4-channel 4K high definition series and 4-channel high definition series, only the channel 1 to channel 4 indicator lights is effective.

2.2.2 9-Channel 4K High Definition (With 4 Input Ports) Series / 9-Channel 4K High Definition Series /9-Channel High Definition Series/16-Channel High Definition Series

The 9-channel 4K high definition (with 4 input ports) series /9-channel 4K high definition series /9-channel high definition series front panel is shown as in Figure 2-2.



Figure 2-2







The 16-channel high definition series front panel is shown as in Figure 2-3.



Figure 2-3

Please refer to the following sheet for detailed information.

Name	Icon	Function
Power button		Press it for three seconds to boot up or shut down the device.

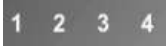
Name	Icon	Function
		Press it three times within one second, it can clear device configuration.
Power indicator light		The indicator light becomes on when system boots up.
Network indicator light		The indicator light becomes on when abnormal network event occurs (offline, IP conflict and etc.)
USB port		Connect to external USB device.
Alarm indicator light		The light becomes on when there is an alarm.
HDD indicator light		N/A
IR receiver		N/A
Output indicator light		<p>It is to display output port working mode.</p> <ul style="list-style-type: none"> For 9-channel 4K high definition series/ 9-channel 4K high definition (with 4 input ports) series/9-channel high definition series, only the channel 1 to channel 9 indicator lights are effective. For 16-channel high definition series, only the channel 1 to channel 16 indicator lights are effective.

2.2.3 12-Channel 4K High Definition Series/12-Channel 4K High Definition (With 4 Input Ports) Series/ 15-Channel 4K High Definition Series/15-Channel 4K High Definition (With 4 Input Ports) Series/ 18-Channel 4K High Definition Series/18-Channel 4K High Definition (With 4 Input Ports) Series/ 21-Channel 4K High Definition Series/21-Channel 4K High Definition (With 4 Input Ports) Series

The front panel is shown as below. See Figure 2-4.

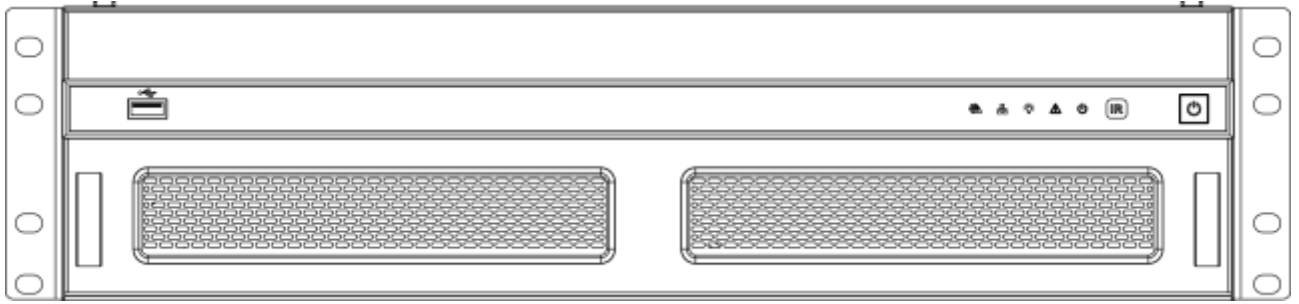









Figure 2-4

Please refer to the following sheet for detailed information.

Name	Icon	Function
Power button		Press it for three seconds to boot up or shut down the device.
IR receiver		N/A
Power indicator light		The indicator light becomes on when system boots up.
Alarm indicator light		The light becomes on when there is an alarm.
Running indicator light		The light is on when device is running.
Network indicator light		N/A
Fan indicator light		N/A
USB port		Connect to external USB device.

2.3 Rear Panel

2.3.1 1-Channel 4K High Definition/1-Channel 4K (H.265) High Definition Series

The rear panel is shown as below. See Figure 2-5.

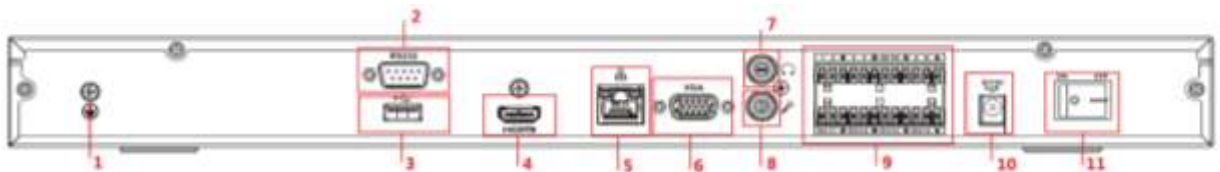

Figure 2-5

Please refer to the following sheet for detailed information.

SN	Port Name	SN	Port Name	SN	Port Name
1	Ground screw hole	2	RS232 port	3	USB port
4	HDMI port	5	Network interface(10M/100M/1000M self-adaptive Ethernet port)	6	VGA port
7	Audio talk output port RCA OUT	8	Audio talk input port RCA IN	9	4-channel alarm input, 4-channel alarm output, RS485 port.
10	Power socket	11	Power on-off button	-	-

2.3.2 4-Channel 4K High Definition Series

The rear panel is shown as below. See Figure 2-6.

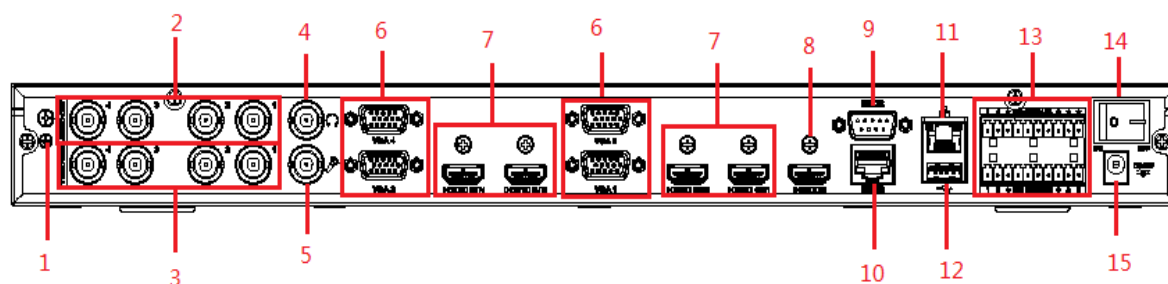

Figure 2-6

Please refer to the following sheet for detailed information.

SN	Port Name	SN	Port Name	SN	Port Name
1	Ground screw hole	2	Audio output port(BNC)	3	Video output port (BNC)
4	Audio talk input port	5	Audio talk output port	6	VGA port
7	HDMI output port	8	HDMI input port	9	RS232 port
10	RS232 port to control the screen	11	Network interface(10M/100M/1000M self-adaptive Ethernet port)	12	USB port
13	Alarm input, alarm output, standard RS485 port	14	Power on-off button	15	Power socket

2.3.3 9-Channel 4K High Definition (With 4 Input Ports) Series

The rear panel is shown as below. See Figure 2-7.

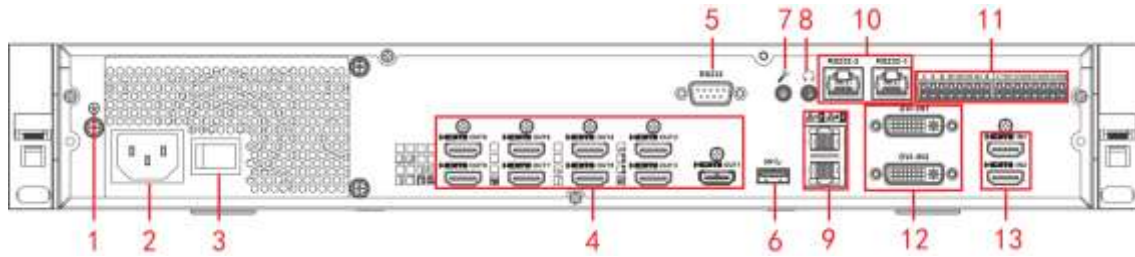

Figure 2-7

Please refer to the following sheet for detailed information.

SN	Port Name	SN	Port Name	SN	Port Name
1	Ground screw hole	2	Power socket	3	Power on-off button
4	HDMI output port	5	RS232 port	6	USB3.0 port
7	Audio talk input port	8	Audio talk output port	9	Network interface(10M/100M /1000M self-adaptive Ethernet port)
10	RS232 port to control the screen	11	Alarm input, alarm output, standard RS485 port	12	DVI-I input port
13	HDMI input port	-	-	-	-

2.3.4 9-Channel 4K High Definition Series

The rear panel is shown as below. See Figure 2-8.

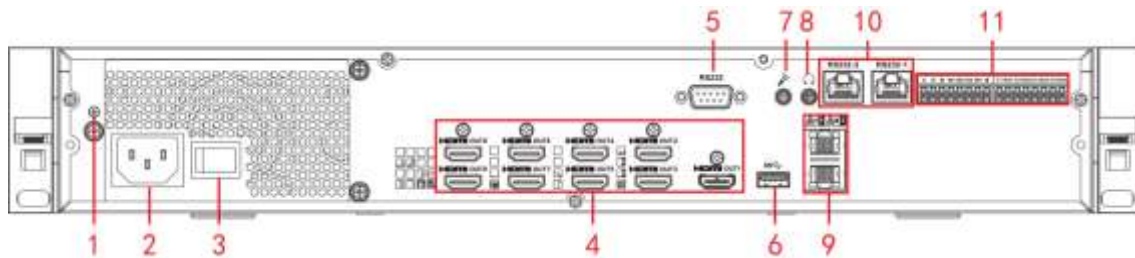

Figure 2-8

Please refer to the following sheet for detailed information.

SN	Port Name	SN	Port Name	SN	Port Name
1	Ground screw hole	2	Power socket	3	Power on-off button
4	HDMI input port	5	RS232 port	6	USB3.0 port
7	Audio talk input port	8	Audio talk output port	9	Network interface(10M/100M/1000M self-adaptive Ethernet port)

SN	Port Name	SN	Port Name	SN	Port Name
10	RS232 port to control the screen	11	Alarm input, alarm output, standard RS485 port	-	-

2.3.5 9-Channel High Definition Series

The rear panel is shown as below. See Figure 2-9.

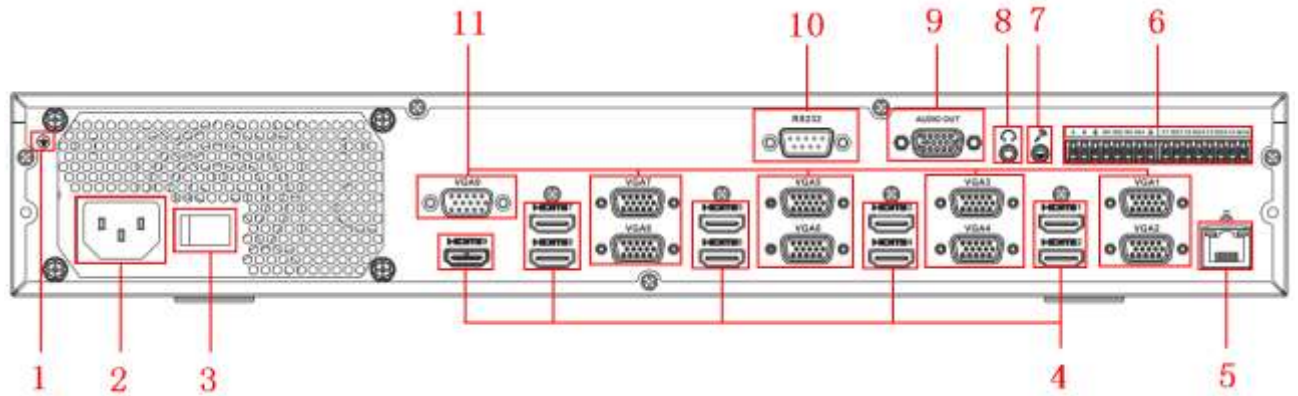

Figure 2-9

Please refer to the following sheet for detailed information.

SN	Port Name	SN	Port Name	SN	Port Name
1	Ground screw hole	2	Power on-off button	3	Power socket
4	HDMI port	5	Network interface(10M/100M/1000M self-adaptive Ethernet port)	6	Relay input, relay output, standard RS485 port.
7	Audio talk input port	8	Audio talk output port	9	Audio output port
10	RS232 port	11	VGA port	-	-

2.3.6 16-Channel High Definition Series

The rear panel is shown as below. See Figure 2-10.

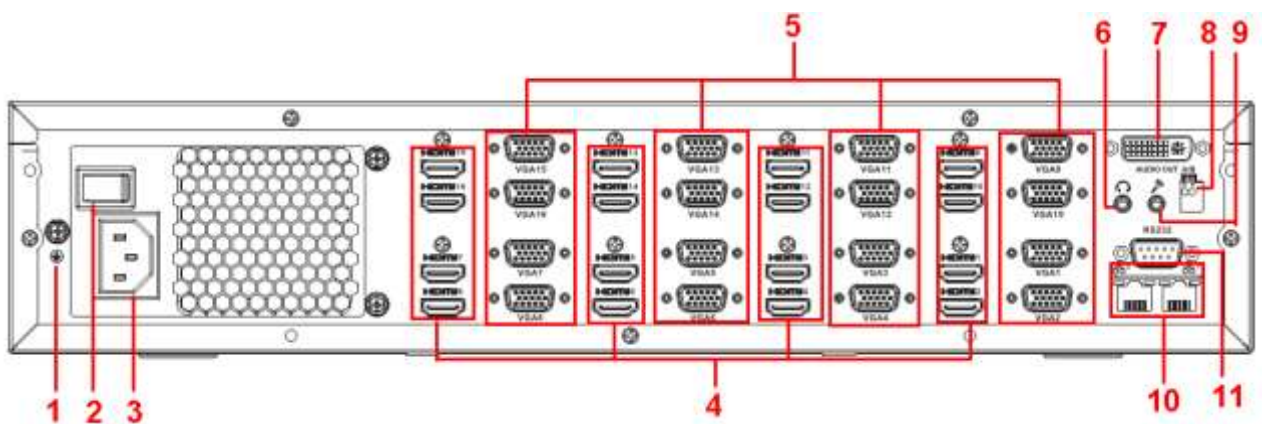

Figure 2-10

Please refer to the following sheet for detailed information.

SN	Port Name	SN	Port Name	SN	Port Name
1	Ground screw hole	2	Power on-off button	3	Power socket
4	HDMI port (16)	5	VGA port (16)	6	Audio talk output port
7	Audio output port	8	Standard RS485 port	9	Audio talk input port
10	Network interface(10M/100M/1000M self-adaptive Ethernet port)	11	RS232 port	-	-

2.3.7 12-Channel 4K High Definition Series/12-Channel 4K High Definition (With 4 Input Ports) Series/ 15-Channel 4K High Definition Series/15-Channel 4K High Definition (With 4 Input Ports) Series/ 18-Channel 4K High Definition Series/18-Channel 4K High Definition (With 4 Input Ports) Series/ 21-Channel 4K High Definition Series/21-Channel 4K High Definition (With 4 Input Ports) Series

The 21-channel 4K high definition series/21-channel 4K high definition (with 4 input ports) series rear panel is shown as below. See Figure 2-11.

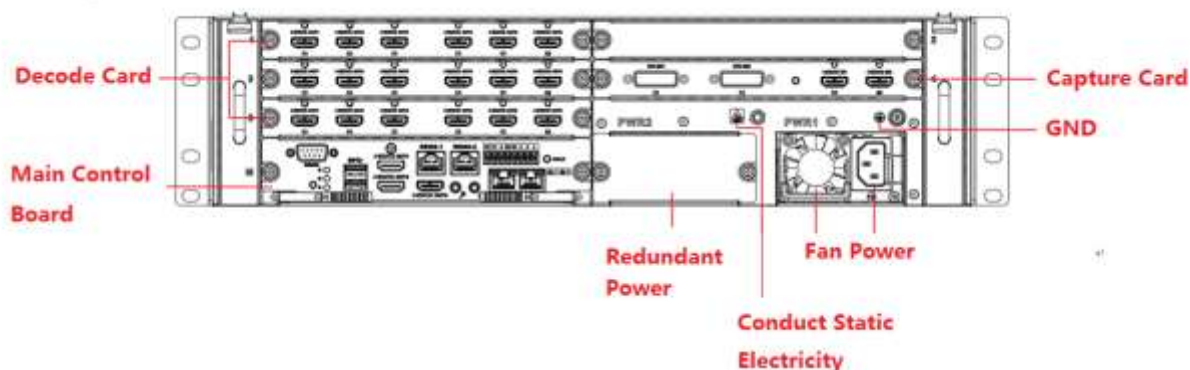

Figure 2-11

The 18-channel 4K high definition series/18-channel 4K high definition (with 4 input ports) series rear panel is shown as below. See Figure 2-12.

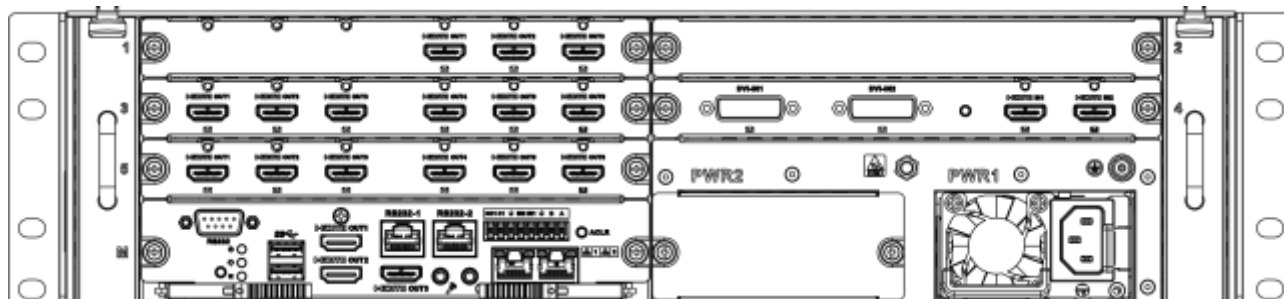

Figure 2-12

The 15-channel 4K high definition series/15-channel 4K high definition (with 4 input ports) series rear panel is shown as below. See Figure 2-13.

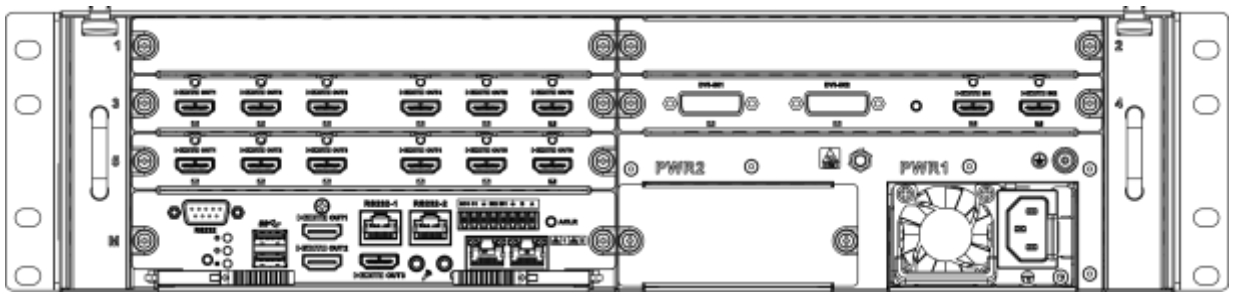

Figure 2-13

The 12-channel 4K high definition series/12-channel 4K high definition (with 4 input ports) series rear panel is shown as below. See Figure 2-14.

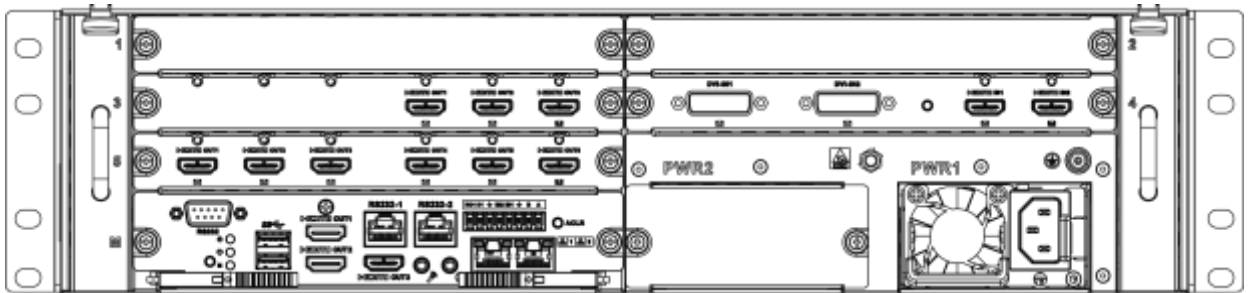

Figure 2-14

Note

- For the above four series, they only have different decode card types. The rest parts are the same.
- For XX-channel 4K high definition series and XX-channel 4K high definition (with 4 input ports) series, the only difference is one series has the capture card and the other does not have capture card. The rest parts are the same.

Main control board

The control board interface is shown as below. See Figure 2-15.

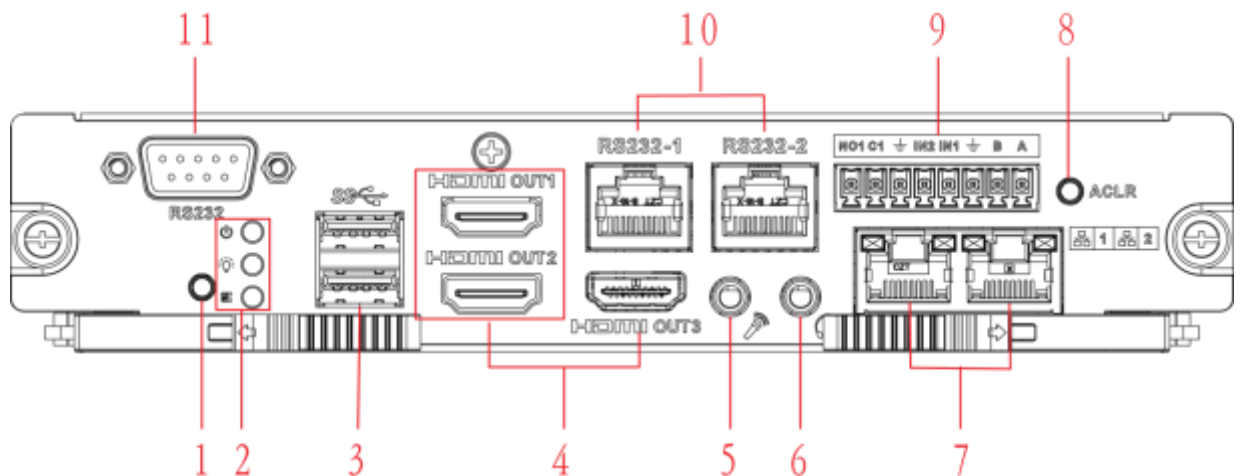

Figure 2-15

Please refer to the following sheet for detailed information.

SN	Name	SN	Name	SN	Name
1	Default button	2	<ul style="list-style-type: none"> ● Main control board power indicator light, ● system status indicator light, ● PCI-E status indicator light 	3	USB port
4	HDMI output port	5	Audio talk input port	6	Audio talk output port
7	Network port	8	Clear alarm button	9	<ul style="list-style-type: none"> ● 2-channel alarm input, 1-channel alarm output , ● RS485 port.
10	RJ45 COM port	11	RS232 COM port	-	-

Decode card

The 3-channel decode card is shown as in Figure 2-16.

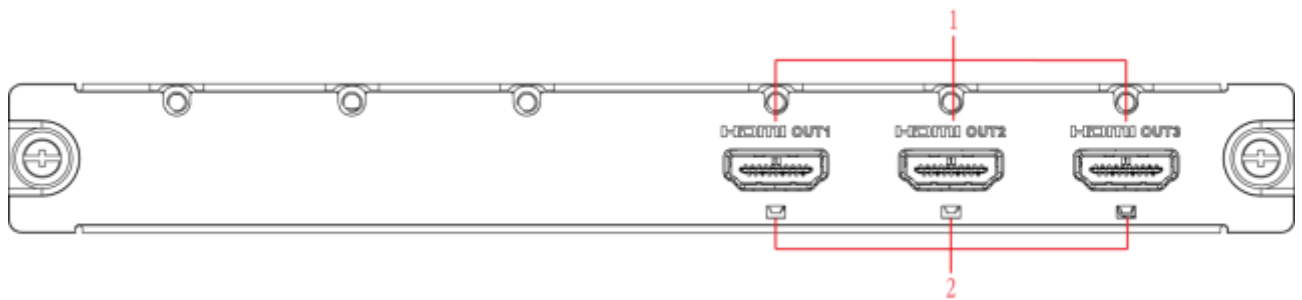

Figure 2-16

The 6-channel decode card is shown as in Figure 2-17.

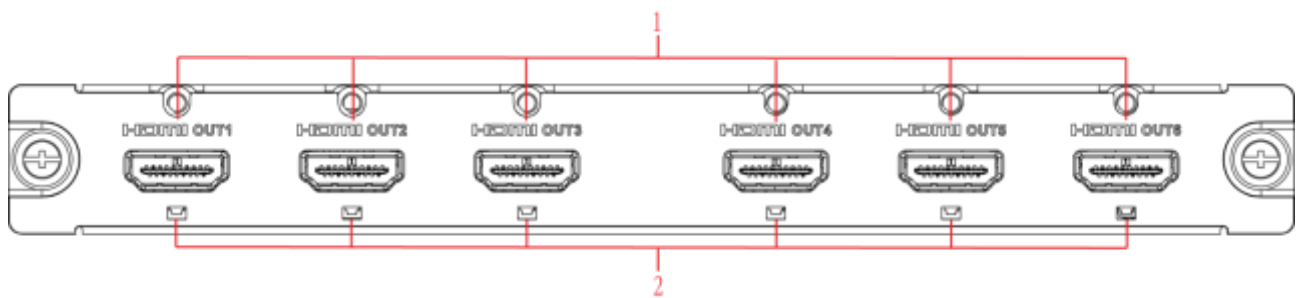

Figure 2-17

Please refer to the following sheet for detailed information.

SN	Port Name	SN	Port Name	SN	Port Name
1	HDMI output port	2	Indicator light	-	-

Capture card

The capture card is shown as in Figure 2-18.

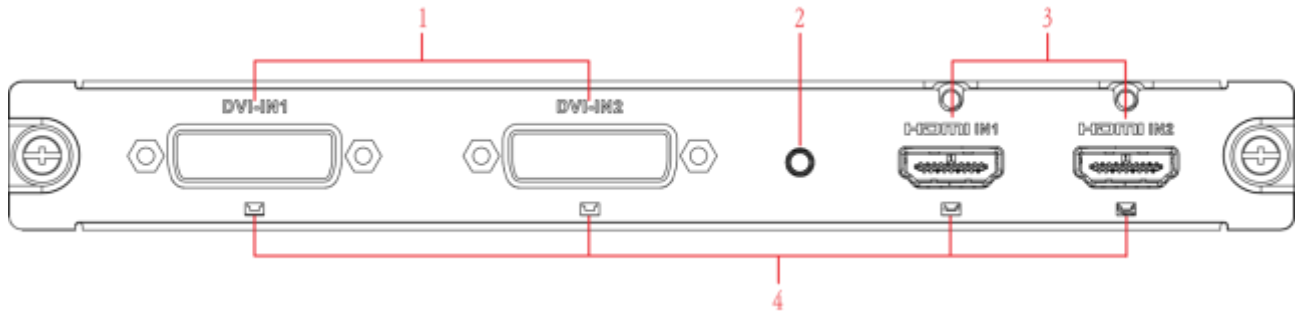

Figure 2-18

Please refer to the following sheet for detailed information.

SN	Name	SN	Name	SN	Name
1	DVI input port	2	Backup button	3	HDMI input port
4	Indicator light	-	-	-	-

Note

- When you connect it to the PC network port, please use crossover cable.
- When you connect it to the PC via router or switch, please use straight cable.

2.4 Connection

2.4.1 General Connection

Please refer to the follow figure for connection information. See Figure 2-19.

The following figure is based on the 4-channel 4K high definition series product.

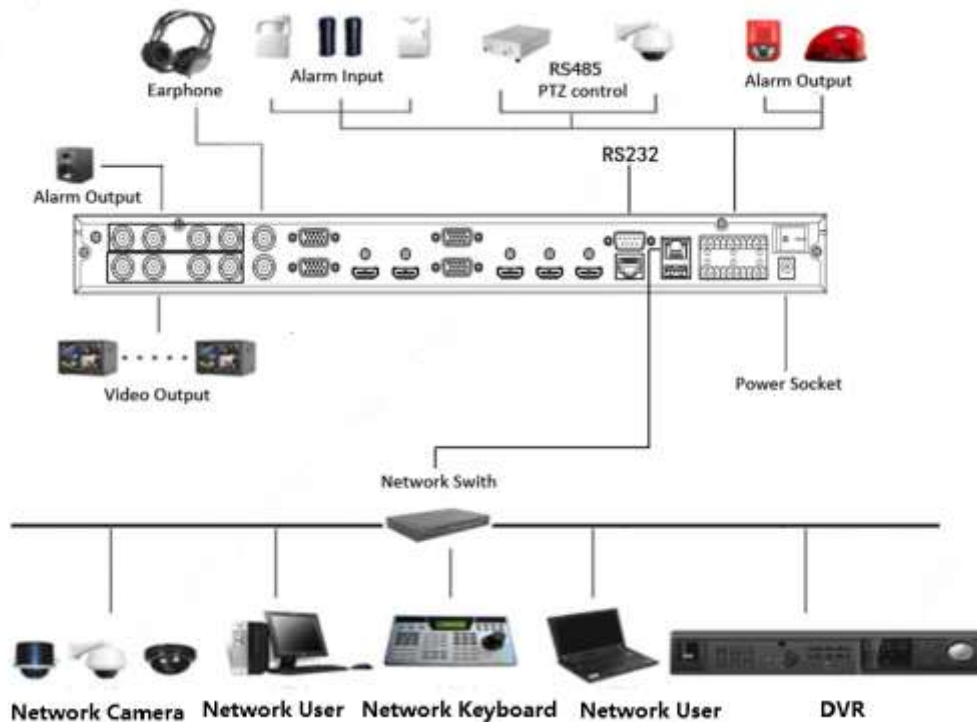

Figure 2-19

2.4.2 Audio/Video Connection

All audio and video data are encoding from the front-end device and then input to the network via RJ45 port.

2.4.3 Audio Talk Input Connection

- 4-channel 4K high definition series adopts BNC port.
- 1-channel 4K high definition/1-channel 4K (H.265) high definition series adopts RCA port.
- 9-channel 4K high definition (with 4 input ports) series/9-channel 4K high definition series/9-channel high definition series/16-channel high definition series/12-channel 4K high definition series/12-channel 4K high definition (with 4 input ports) series/15-channel 4K high definition series/15-channel 4K high definition (with 4 input ports) series/18-channel 4K high definition series/18-channel 4K high definition (with 4 input ports) series/21-channel 4K high definition series/21-channel 4K high definition (with 4 input ports) series adopts 3.5mm jack port.

2.4.4 Video Output Device and Connection

- 1-channel 4K high definition series adopts one output set. Each set has one VGA port, one HDMI port.
- 1-channel 4K (H.265) high definition series adopts one output set. Each set has one VGA port, one HDMI port.
- 4-channel 4K high definition series adopts four output sets. Each set has one VGA port, one HDMI port and one BNC; BNC(1.0VP-P, 75Ω).
- 9-channel 4K high definition series/9-channel 4K high definition (with 4 input ports) series each adopts nine output sets, nine HDMI ports.
- 9-channel high definition series adopts nine output sets. Each set has one VGA port, one HDMI port.
- 16-channel high definition series adopts sixteen output sets. Each set has one VGA port, one HDMI port.
- 12-channel 4K high definition series/12-channel 4K high definition (with 4 input ports) series adopts twelve output sets. Each set has twelve HDMI port.
- 15-channel 4K high definition series/15-channel 4K high definition (with 4 input ports) series adopts fifteen output sets. Each set has fifteen HDMI port.
- 18-channel 4K high definition series/18-channel 4K high definition (with 4 input ports) series adopts eighteen output sets. Each set has eighteen HDMI port.
- 21-channel 4K high definition series/21-channel 4K high definition (with 4 input ports) series adopts twenty-one output sets. Each set has twenty-one HDMI port.

Here we recommend the industry monitor to be the output device of the decoder. It has the following advantages:

- The industry monitor is suitable for long time surveillance. The pc monitor cannot run for such a long time. It is easy to be aging, damage or burn down.
- Industry monitor has stronger vivid and colorful video.
- Industry monitor can be used in many complicated environments and has strong anti-interference capability. It is more stable.

Please note, using TV as video output device is not a reliable substitution method. You need to reduce the working hours and control the interference from power supply and other devices. The risk of short circuit problem resulting from low quality TV may cause damage to other devices.

2.4.5 Audio Output

The audio output parameter of device is 200mV 1k Ω (BNC), it can connect directly to low impedance earphone, active sound box or amplifier-drive audio output device.

If the sound box and the pick-up cannot be separated spatially, it is easy to arouse squeaking. In this case you can adopt the following measures:

- Use pick-up with better directing property.
- Reduce the volume of the sound box until there is no squeaking.
- Using more sound-absorbing materials in decoration to reduce voice echo and improve acoustics environment.
- Adjust the layout to reduce risk of the squeaking.

3 Operation

Note

- The following operations are generally based on the 9-channel high definition series product.
- Slight different may be found on the user interface.

3.1 Boot up

Connect the device to the power and then press the power button in the rear panel. You can see the power indicator light becomes on and device boots up.

The system is in multiple-window display mode by default.

3.2 Shut down

You can press power button in the front panel for three seconds to shut down the device.

Note

When decoder is working, if the power failure occurs, the system can automatically connect to the front-end device and restore previous working status once the power connection becomes normal.

3.3 Network Connection

Step 1 Use network cable to connect the Ethernet port of the device and the PC NIC port together. Make sure the device connection is OK.

Step 2 Set PC and device in the same IP segment.

Note

Device default IP address is 192.168.1.108.

Step 3 Use order ping `***.***.***.***`(Device IP address) to check connection is OK or not. Usually the return TTL value should be less than 64.

Step 4 Open Internet Explorer and then input the address in the column. Click **【Enter】** button.

Note

WEB control can be downloaded and installed automatically. System can download the latest Web control and remove the old one.

After login the WEB interface, please change device IP address according to the actual situation. Refer to chapter 3.12.2 Network for detailed information.

Step 5 Connect the device to the network.

3.4 Login

Note

Different series products have different login modes.

3.4.1 4-channel high definition series/16-channel high definition series/1-channel 4K high definition series/1-channel 4K(H.265) high definition series/4-channel 4K high definition series/12-channel 4K high definition series/12-channel 4K high definition (with 4 input ports) series/15-channel 4K high definition series/15-channel 4K high definition (with 4 input ports) series/18-channel 4K high definition series/18-channel 4K high definition (with 4 input ports) series/21-channel 4K high definition series/21-channel 4K high definition (with 4 input ports) series

- Step 1 Open the Internet Explorer and then input the device IP address in the address column, click **【Enter】** button.
- Step 2 Device pops up Install plug-in interface. Please click OK and follow the prompts to install the plug-in. If you can't download the plug-in file, please modify your Internet Explorer security setup. After installation, the interface is shown as below. See Figure 3-1.



Figure 3-1

- Step 3 Please input your user name and password and then click Login button.

 **Note**

Default factory name is **admin** and password is **admin**.

Device pops up Modify Password dialogue box. See Figure 3-2.



Figure 3-2

- Step 4 Please input the new password twice and then click the Yes button.

 **Note**

The password ranges from 8 to 32 digitals. It can contain letters, numbers and special characters (excluding “'” , “”” , “.”” , “:.”” , “&”) . The password shall contain at least two categories. Usually we recommend the strong password.



WARNING

STRONG PASSWORD RECOMMENDED-For your device own safety, please create a strong password of your own choosing. We also recommend you change your password periodically especially in the high security system.

Step 5 After successfully set the new password, system asks you to login again. Please input the user name admin and new password to login.

 **Note**

- Different series products have different login interfaces. Please refer to the actual interface for detailed information.
- For 9-channel high definition series/16-channel high definition series/1-channel 4K high definition series/1-channel 4K (H.265) high definition series, the interface is shown as in Figure 3-3. For 12-channel 4K high definition series/12-channel 4K high definition (with 4 input ports) series/ 15-channel 4K high definition series/15-channel 4K high definition (with 4 input ports) series/ 18-channel 4K high definition series/18-channel 4K high definition (with 4 input ports) series/ 21-channel 4K high definition series/21-channel 4K high definition (with 4 input ports) series, the interface is shown as Figure 3-4. For 4-channel 4K high definition series, the interface is shown as below. See Figure 3-5.

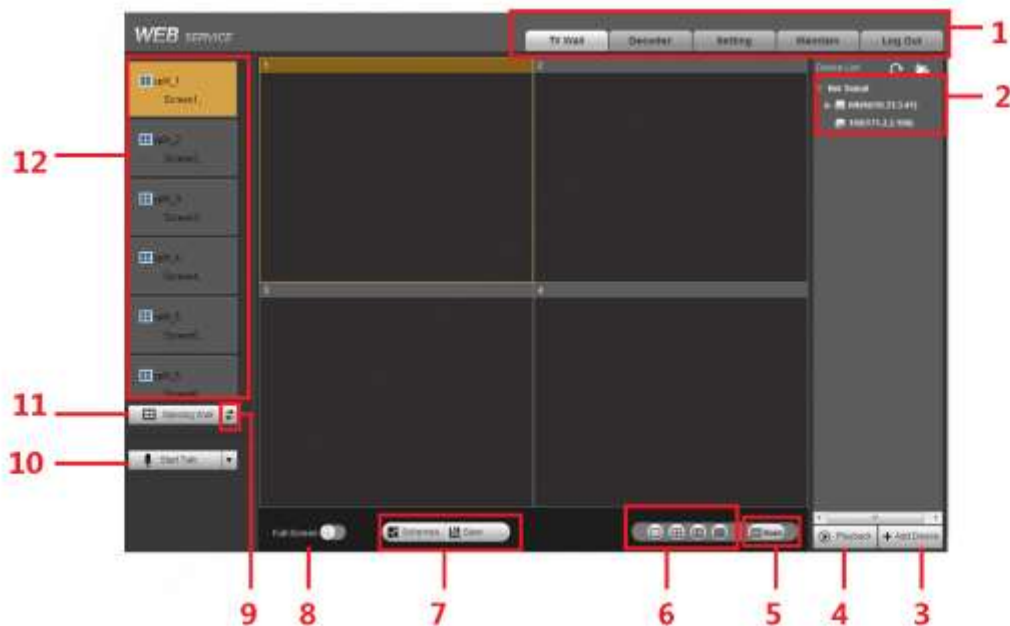

Figure 3-3

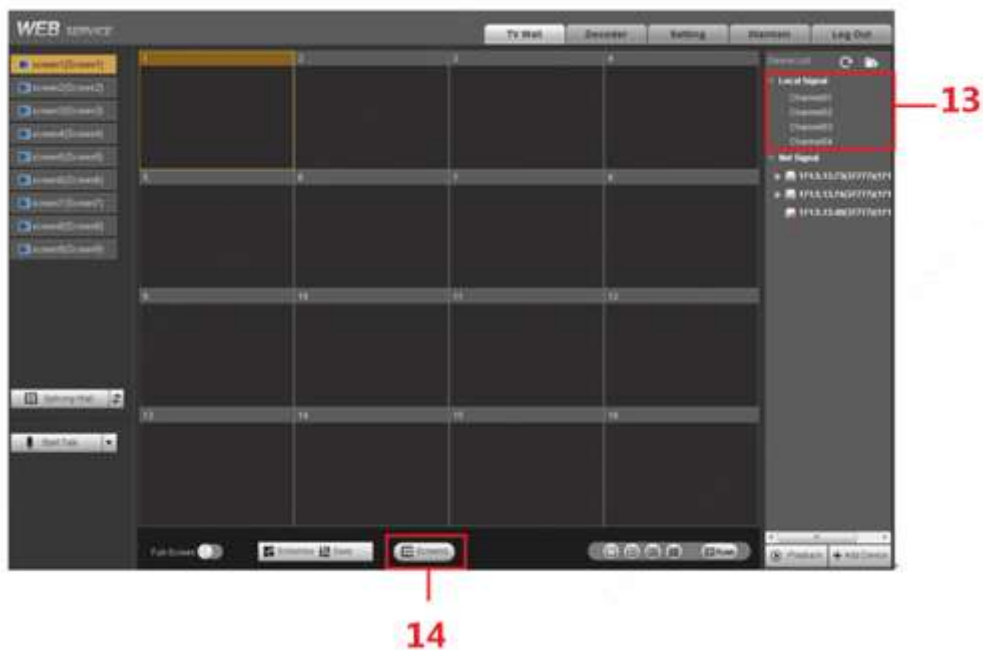

Figure 3-4

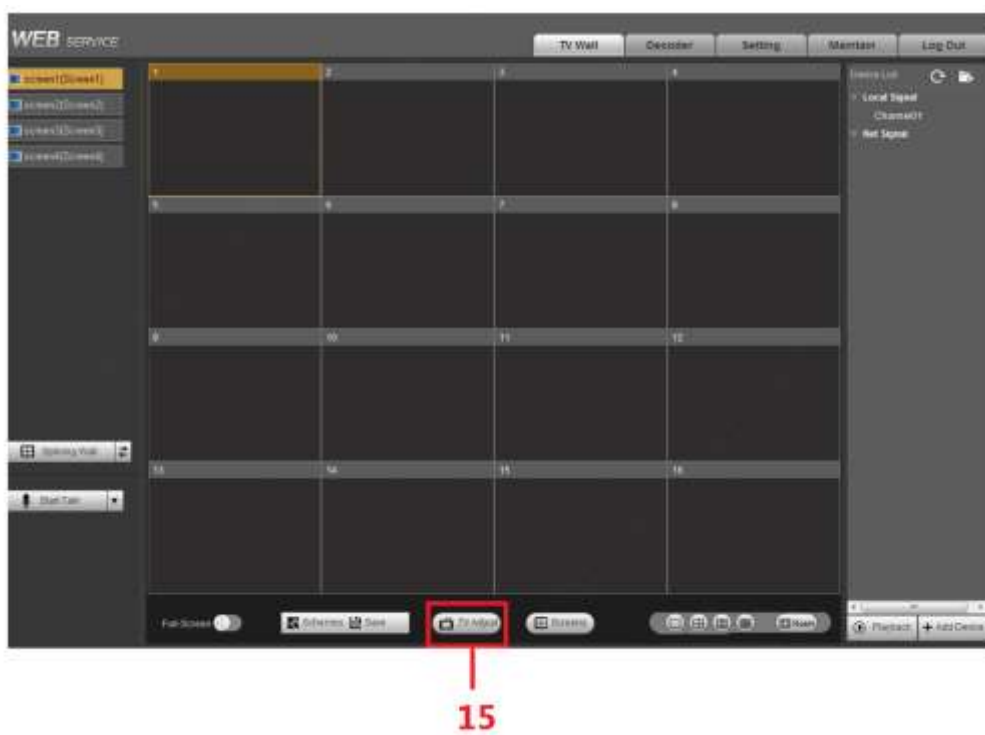

Figure 3-5

Please refer to the following sheet for detailed information.

SN	Name	SN	Name
1	System menu	2	Network signal
3	Add/delete device	4	Playback
5	Roam	6	Window split

SN	Name	SN	Name
7	Scheme manager/Save	8	Full-screen button
9	Refresh	10	Bidirectional talk
11	Splicing wall	12	Screen No.
13	Local signal	14	Screen manager
15	TV adjustment	-	-

3.4.2 9-channel 4K high definition series/9-channel 4K high definition (with 4 input ports) series

Step 1 Open the Internet Explorer and then input IP address on the address column, click **【Enter】** button.

Enter Initialization interface. See Figure 3-6.

Figure 3-6

Step 2 Input password and then confirm, click OK button. See Figure 3-7.

Note

The password ranges from 8 to 32 digitals. It can contain letters, numbers and special characters (excluding “'”, “””, “;”, “:”, “&”). The password shall contain at least two categories. Usually we recommend the strong password.



WARNING

STRONG PASSWORD RECOMMENDED-For your device own safety, please create a strong password of your own choosing. We also recommend you change your password periodically especially in the high security system.

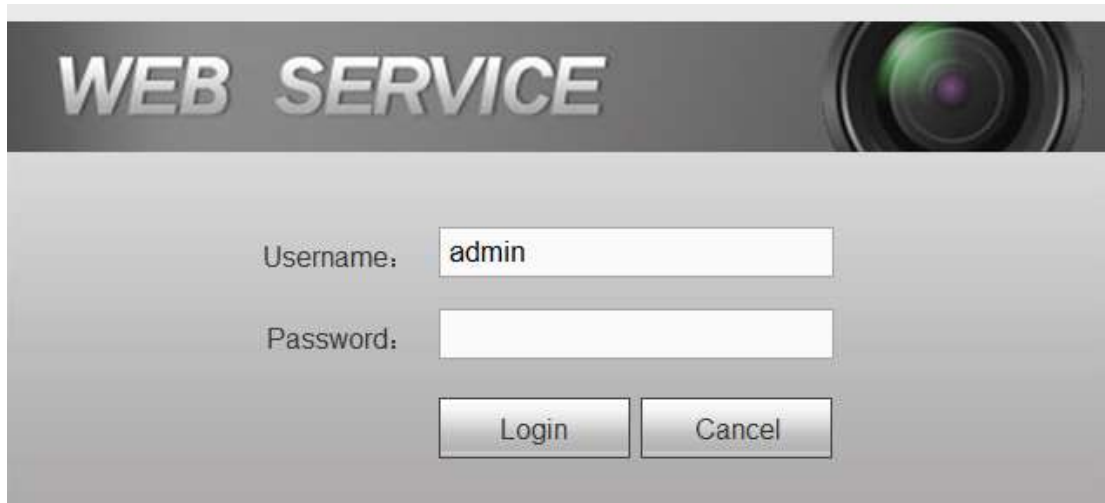

Figure 3-7

Step 3 Input the password and then click Login.

 **Note**

System default user name is **admin**.

3.5 WEB Live Interface

3.5.1 System menu

There are system menu buttons. Please refer to chapter 3.10 Decoder configuration, chapter 3.12 Setting, chapter 3.13 Maintain and chapter 3.14 Logout for detailed information.

3.5.2 Screen No.

Model	Decoded Channel	Note
9-channel high definition series	48	The Web adopts the TV screen to display. There are total 9 TV screens corresponding to 9 groups output. You can use the 9 icons at the top left corner to select the screen. The first TV screen has 16-channel; the screen 2 to screen 4 each has 4-channel.
16-channel high definition series	64	The Web adopts the TV screen to display. There are 16 screens corresponding to 16 groups output. You can use the 16 icons at the top left corner to select the screen. The 1 to 16 screen has 4-channel.
1-channel 4K high definition series/1-channel 4K(H.265) high definition series	64	The Web adopts the TV screen to display. There is 1 screen corresponding to 1 group output. You can use the one icon at the top left corner to select the screen. The first screen has 16-channel.

Model	Decoded Channel	Note
4-channel 4K high definition series	64	The Web adopts the TV screen to display. There are 4 screens corresponding to 4 groups output. You can use four icons at the top left corner to select the screen. Each screen has 16-channel.
9-channel 4K high definition series/9-channel 4K high definition (with 4 input ports) series	144	The Web adopts the TV screen to display. There are 9 screens corresponding to 9 groups output. You can use nine icons at the top left corner to select the screen. Each screen has 16-channel.
12-channel 4K high definition series/12-channel 4K high definition (with 4 input ports) series	192	The Web adopts the TV screen to display. There are 12 screens corresponding to 12 groups output. You can use the 12 icons at the top left corner to select the screen. The screen each has 16-channel.
15-channel 4K high definition series/15-channel 4K high definition (with 4 input ports) series	240	The Web adopts the TV screen to display. There are 12 screens corresponding to 15 groups output. You can use the 15 icons at the top left corner to select the screen. The screen each has 16-channel.
18-channel 4K high definition series/18-channel 4K high definition (with 4 input ports) series	288	The Web adopts the TV screen to display. There are 12 screens corresponding to 18 groups output. You can use the 18 icons at the top left corner to select the screen. The screen each has 16-channel.
21-channel 4K high definition series/21-channel 4K high definition (with 4 input ports) series	336	The Web adopts the TV screen to display. There are 21 screens corresponding to 21 groups output. You can use the 21 icons at the top left corner to select the screen. The screen each has 16-channel.

3.5.3 Splicing wall

Click  Splicing Wall, you can set splicing wall function. Please refer to chapter 3.6 for detailed information.

3.5.4 Bidirectional talk

It realizes the bidirectional talk between the WEB and the decoder. Please click 

button of the  StartDialog button to select corresponding bidirectional talk mode from the

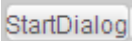
dropdown list. Click  button to begin bidirectional talk between the WEB and the decoder.

3.5.5 Connected front-end device list

3.5.5.1 Folder

It is to display added front-end device, device encode list and front-end device status. See Figure 3-8.

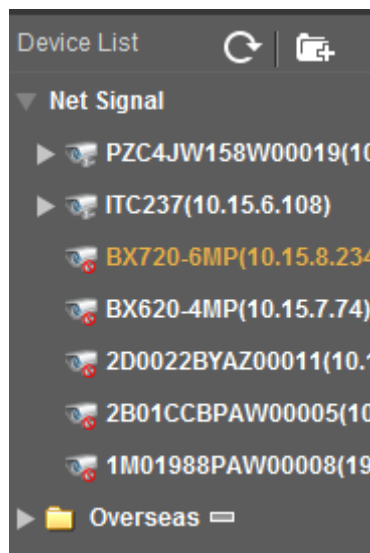



Figure 3-8

- Click  to add new folder. The folder name supports customized settings.

After adding the new folder, you can use following two modes to add the device to the folder and manage the device.

- ✧ Drag the device to the folder to manage
- ✧ Right click device and then select folder. It is to add the device to the folder.

- Move the cursor to the folder and then click  to delete the folder.

3.5.5.2 Local signal collection



Note

This function is for 4-channel 4K high definition series/9-channel 4K high definition (with 4 input ports) series/12-channel 4K high definition (with 4 input ports) series/15-channel 4K high definition (with 4 input ports) series/18-channel 4K high definition (with 4 input ports) series/21-channel 4K high definition (with 4 input ports) series product support local signal collection function.

The 4-channel 4K high definition series has 1-channel local signal by default.

See Figure 3-9.

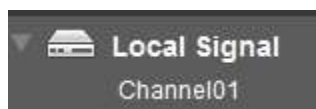

Figure 3-9

The 9-channel 4K high definition (with 4 input ports) series/12-channel 4K high definition (with 4 input ports) series/15-channel 4K high definition (with 4 input ports) series/18-channel 4K high definition (with 4 input ports) series/21-channel 4K high definition (with 4 input ports) series has 4-channel local signals by default. See Figure 3-10. The following figure is based on 9-channel 4K high definition (with 4 input ports) series product.



Figure 3-10

Click  to change local channel name. See Figure 3-11.

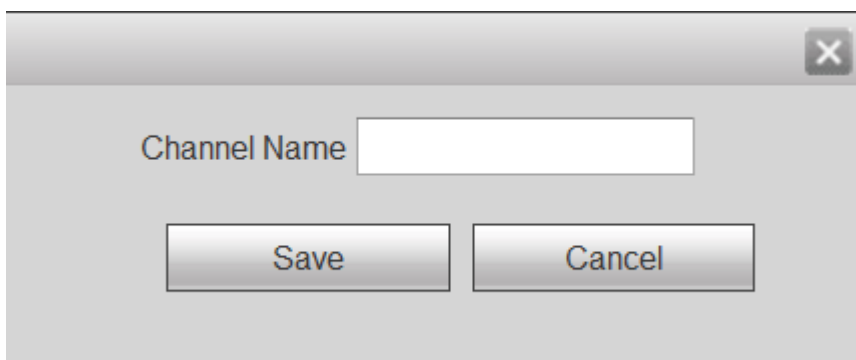

Figure 3-11

Note

The 12-channel 4K high definition (with 4 input ports) series/15-channel 4K high definition (with 4 input ports) series/18-channel 4K high definition (with 4 input ports) series/21-channel 4K high definition (with 4 input ports) series product cannot modify local channel name.

3.5.6 Add/delete device

Add/delete front-end of the decoder.

3.5.7 Playback

You can select playback by file or by time.

3.5.8 Window split

There are four display modes: 1/4/9/16 window split. Take the first TV screen for an example: there are 16 options for single-window mode: channel 1, Channel

2.....channels 16. There are 4 options for four-window mode: 1-4ch, 5-8ch, 9-12ch, 13-16 ch. There are two options for nine-window mode: 1-9ch, 8-16ch. There is one option for 16-window mode: 1-16channel.

Single click and choose any decode channel to connect real-time decode output. See Figure 3-12 through Figure 3-14.

 **Note**

Different series products may have different decode channel interfaces. Please refer to the actual produce for detailed information.

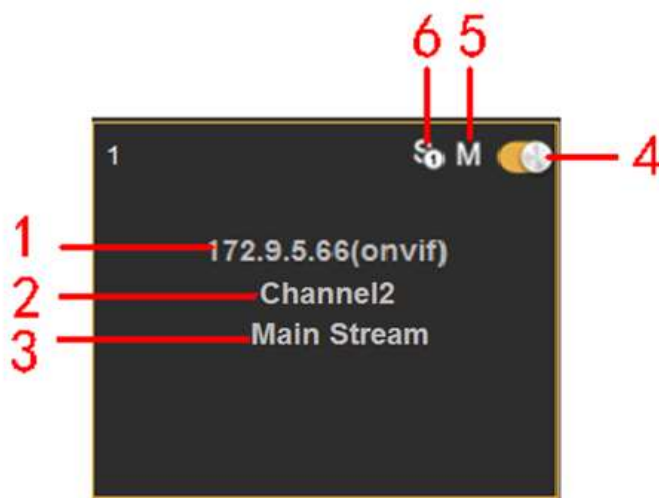

Figure 3-12

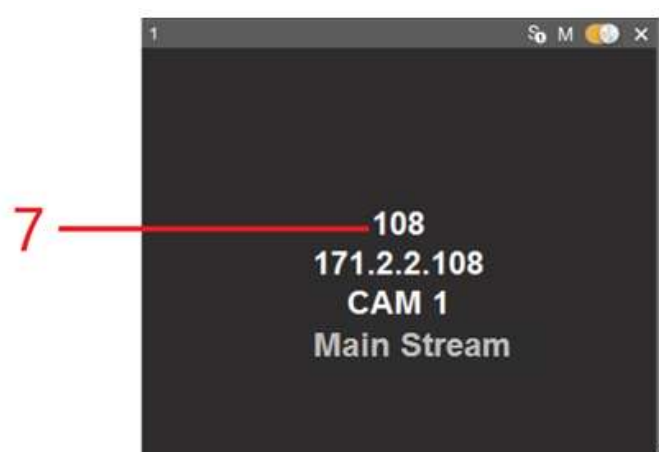

Figure 3-13

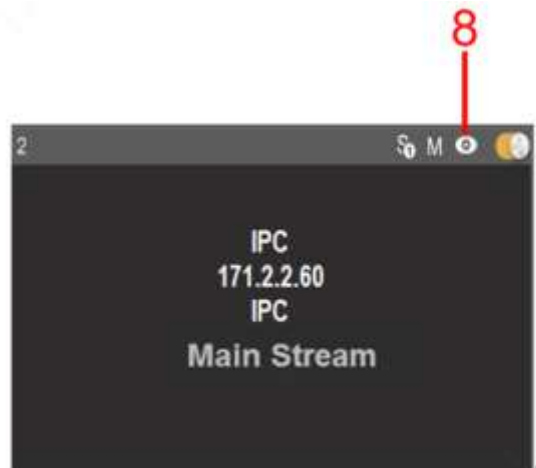







Figure 3-14

Please refer to the following sheet for detailed information.

SN	Function
1	Front-end device IP address.
2	Front-end real-time monitor channel.
3	Connection status. Display current stream type.
4	Click  to enable video, click  to disable the video.
5	Enable main stream
6	Enable sub stream. For some front-end series product of two sub streams. It shown as  .
7	Front-end device name.
8	<p>Click , enter fisheye setting interface. Please refer to chapter 3.5.9 Fisheye for detailed information.</p> <p> Note</p> <ul style="list-style-type: none"> This function is for some series such as 1-channel 4K high definition series/ 1-channel 4K(H.265) high definition series/4-channel 4K high definition series/9-channel 4K high definition (with 4 input ports) series/9-channel 4K high definition series/12-channel 4K high definition series/12-channel 4K high definition (with 4 input ports) series/15-channel 4K high definition series/15-channel 4K high definition (with 4 input ports) series/18-channel 4K high definition series/18-channel 4K high definition (with 4 input ports) series/21-channel 4K high definition series/21-channel 4K high definition (with 4 input ports) series. One screen supports one fisheye channel only.

3.5.9 Fisheye

Please set fisheye installation and display mode according to the actual situation.

 **Note**

- This function is for some series such as 1-channel 4K high definition series/ 1-channel 4K(H.265) high definition series /4-channel 4K high definition series/9-channel 4K high definition (with 4 input ports) series/9-channel 4K high definition series/12-channel 4K high definition series/12-channel 4K high definition (with 4 input ports) series/15-channel 4K high definition series/15-channel 4K high definition (with 4 input ports) series/18-channel 4K high definition series/18-channel 4K high definition (with 4 input ports) series/21-channel 4K high definition series/21-channel 4K high definition (with 4 input ports) series.
- For 1-channel 4K high definition series/ 1-channel 4K(H.265) high definition series /4-channel 4K high definition series, one screen supports one fisheye channel only. For 9-channel 4K high definition (with 4 input ports) series/9-channel 4K high definition series/12-channel 4K high definition series/12-channel 4K high definition (with 4 input ports) series/15-channel 4K high definition series/15-channel 4K high definition (with 4 input ports) series/18-channel 4K high definition series/18-channel 4K high definition (with 4 input ports) series/21-channel 4K high definition series/21-channel 4K high definition (with 4 input ports) series, three screens support one fisheye channel.

Click , enter fisheye interface. See Figure 3-15.

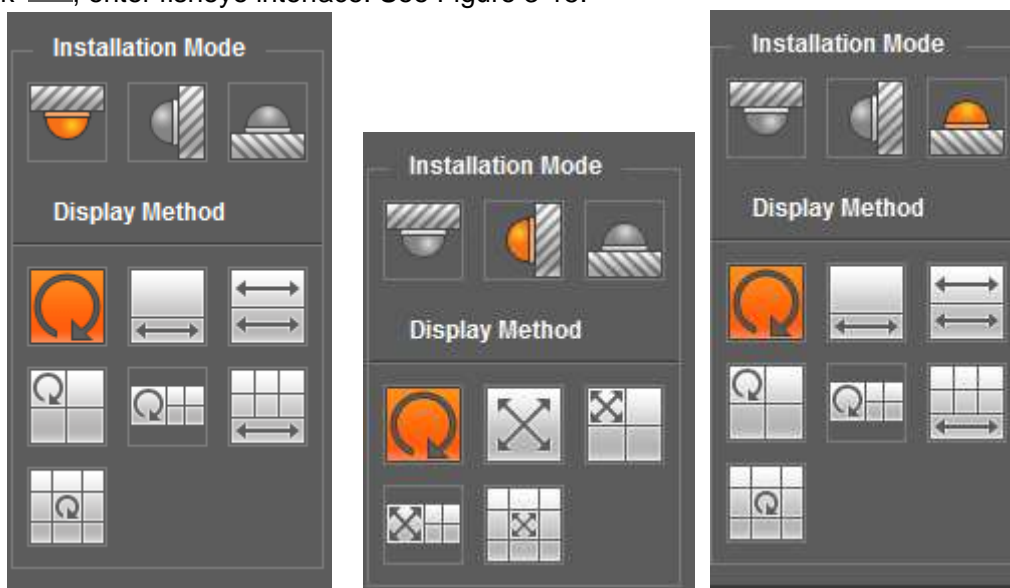













Figure 3-15

Please refer to the following table for detailed information.

Name	Function
Installation mode	There are three installation modes:Ceiling mount/wall mount/ground mount.

Name	Function	
Display mode	<p>Display mode here refers to current video display mode (System supports the original video mode by default.). According to different installation modes, it supports the following display modes:</p> <ul style="list-style-type: none"> • Ceiling mount: 1P+1, 2P, 1+3, 1+4, 1P+6, 1+8. • Wall mount: 1P, 1P+3, 1P+4, 1P+8. • Ground mount: 1P+1, 2P, 1+3, 1+4, 1P+6, 1+8. <p> Note</p> <p>When switch installation mode, system displays original video mode by default.</p>	
Ceiling/wall/ground installation	 Original video	The original video before the dewarp process.
Ceiling/ground installation	 1P+1	360° rectangle panorama+independent sub-window.
	 2P	Two related 180° rectangle windows. In anytime, these two sub-window present the 360° panorama. It is so called dual-panorama.
	 1+3	The original window+3 independent sub-window.
	 1+4	The original video +4 independent sub-windows.
	 1P+6	360° rectangle panorma+6 independent sub-windows.
	 1+8	Original video+8 independent sub-windows.
Wall mount	 1P	From left to right 180° rectangle panorma.
	 1P+3	180° rectangle panorma+3 independent sub-windows.
	 1P+4	180° rectangle panorma+4 independent sub-windows.

Name	Function
	 1P+8

180° rectangle panorama+8 independent sub-windows.

3.5.10 TV adjustment/screens

3.5.10.1 TV Adjust

Note

- It is not for splicing wall. It is for current screen only for BNC output setup.
- This function is for 4-channel 4K high definition series only.

It is to adjust margin. This function is valid for BNC output only. The margin value ranges from 0 to 100.

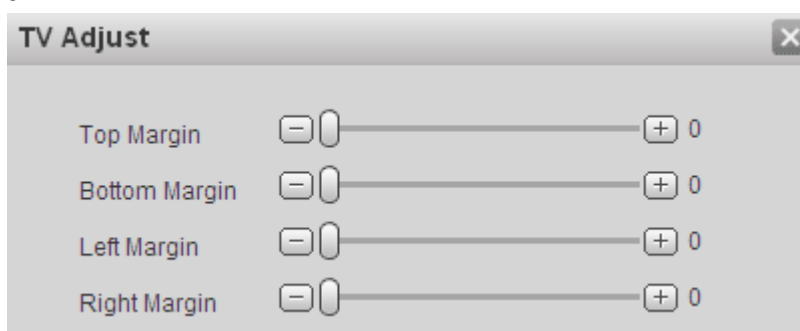



Figure 3-16

3.5.10.2 Screens

Note

- This function is for 4-channel 4K high definition series/ 9-channel 4K high definition series/ 9-channel 4K high definition (with 4 input ports) series/12-channel 4K high definition series/12-channel 4K high definition (with 4 input ports) series/15-channel 4K high definition series/15-channel 4K high definition (with 4 input ports) series/18-channel 4K high definition series/18-channel 4K high definition (with 4 input ports) series/21-channel 4K high definition series/21-channel 4K high definition (with 4 input ports) series product only.
- Before you manage screens, please go to chapter 3.12.3.3 screen control to set parameters.

Click , system pops up screen on-off button, system BLC mode and screen adjust interface. See Figure 3-17.

✧ Screen Power

Before the screen on-off operation, please connect the RJ45 port of the 4-channel 4K high definition series product to the COM port of the monitor.

For the LCD from our company, 2 is to receive data, 3 is to send out data and 5 is GND.

RJ45 COM port of the 4-channel 4K high definition series product: 1 is to receive data, 8 is

to send out data, 5 is GND.

Please connect the 1 of the device to the 3 of the LCD, 8 of the device to the 2 of the LCD, and 5 of the device to the 5 of the LCD. For the other cable, you can just cut off.

The screen on-off interface is shown as below. Select one or more screen(s) or you can check ALL to select all screens, you can see the select screen color is yellow, and then click on/off button.

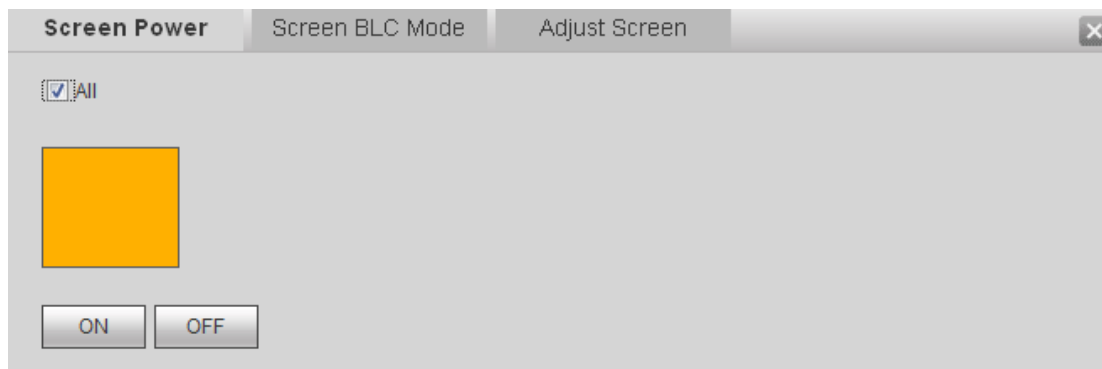

Figure 3-17

✧ Screen BLC Mode



Note

This function is for some screens only.

Click screen BLC mode, you can go to the following interface. Select one or more screen(s) or you can check ALL to select all screens, you can see the select screen color is yellow, and then click Switch mode button. See Figure 3-18.

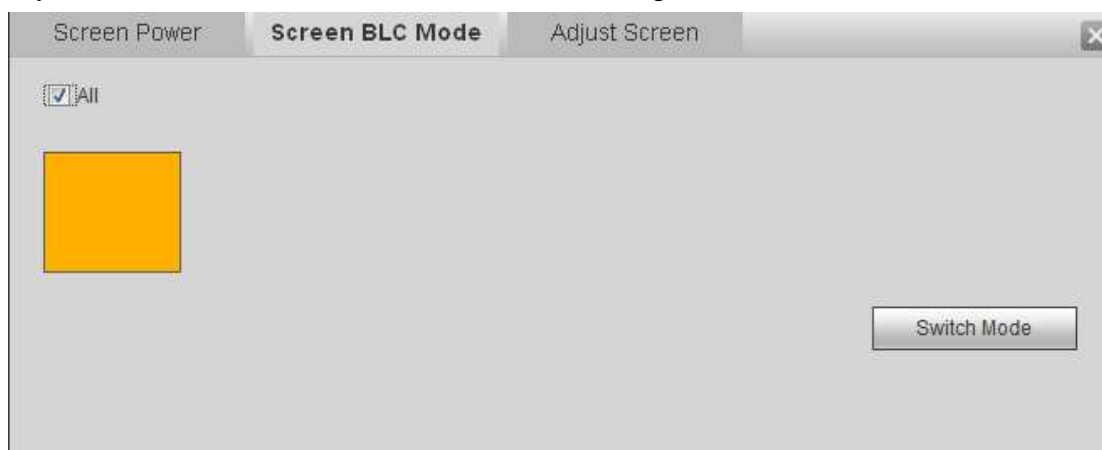

Figure 3-18

✧ Adjust Screen



Note

This function is for some screens only.

Click Adjust screen button, you can go to the following interface. Select a screen; you can see its color is yellow. Use “+” or “-” to adjust the parameters on the DVI, VGA, video mode. Please set according to the device hardware. See Figure 3-19.

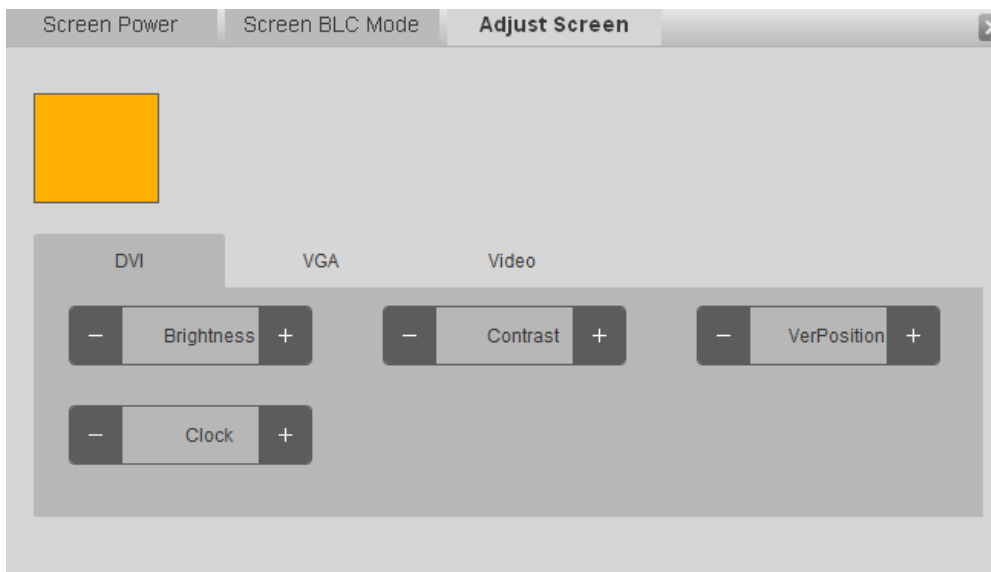



Figure 3-19

3.5.11 Close/Open full-screen monitor

It is to close/open all monitor channel of current TV screen.

3.5.12 Refresh

Click  to view the realtime splicing wall status.

3.5.13 Schemes manager

Please refer to chapter 3.10 for detailed information.

3.5.14 Roam



Note

- System supports several roaming operations at the same time as long as the operation amount is not more than the max split amount.
- System supports overlay function. It has no limitation.

Roam function allows a window to move or zoom in/zoom out in the TV wall.

Click , you can use mouse to drag the video. See Figure 3-20.

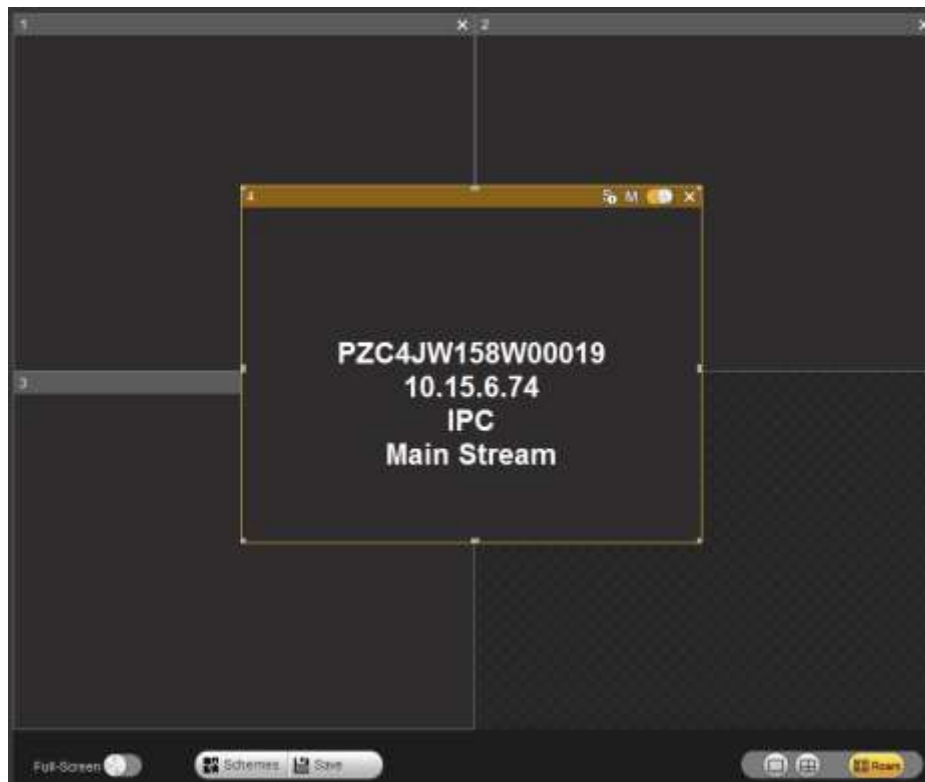

Figure 3-20

3.6 Video Wall Splicing (Display Pane) Function

The video wall splicing function is to output several physical video walls to one screen and these physical video walls can be used as one screen.

3.6.1 Configuring Splicing Screen



Note

- 9-channel high definition series/16-channel high definition series/4-channel 4K high definition series/9-channel 4K high definition series/ 9-channel 4K high definition (with 4 input ports) series/12-channel 4K high definition series/12-channel 4K high definition (with 4 input ports) series/15-channel 4K high definition series/15-channel 4K high definition (with 4 input ports) series/18-channel 4K high definition series/18-channel 4K high definition (with 4 input ports) series/21-channel 4K high definition series/21-channel 4K high definition (with 4 input ports) series support this function.
- The 4-channel 4K high definition series supports $1 \times 1, 1 \times 2, 2 \times 1, 2 \times 2$ splicing mode.
- The 9-channel 4K high definition series / 9-channel 4K high definition (with 4 input ports) series /9-channel high definition series supports $1 \times 1, 1 \times 2, 1 \times 3, 1 \times 4, 1 \times 5, 1 \times 6, 1 \times 7, 1 \times 8, 1 \times 9, 2 \times 1, 2 \times 2, 2 \times 3, 2 \times 4, 3 \times 1, 3 \times 2, 3 \times 3, 4 \times 1, 4 \times 2, 5 \times 1, 6 \times 1, 7 \times 1, 8 \times 1, 9 \times 1$ modes.
- 21-channel 4K high definition series/21-channel 4K high definition (with 4 input ports) series max supports 21 screens setup. It includes: $1 \times 1, 1 \times 2, 1 \times 3, 1 \times 4, 1 \times 5, 1 \times 6, 1 \times 7, 1 \times 8, 1 \times 9, 1 \times 10, 1 \times 11, 1 \times 12, 1 \times 13, 1 \times 14, 1 \times 15, 1 \times 16, 1 \times 17, 1 \times 18, 1 \times 19, 1$

×20,1×21,2×1,2×2,2×3,2×4,2×5,2×6,2×7,2×8,2×9,2×10,3×1,3×2,3×3,3
 ×4,3×5,3×6,3×7,4×1,4×2,4×3,4×4,4×5,5×1,5×2,5×3,5×4,6×1,6×2,6×
 3,7×1,7×2,7×3,8×1,8×2,9×1,9×2,10×1,10×2,11×1,12×1,13×1,14×1,15×
 1,16×1,17×1,18×1,19×1,20×1,21×1 modes.

- 18-channel 4K high definition series/18-channel 4K high definition (with 4 input ports) series max supports 18 screens setup. Please refer to 21-channel 4K high definition series/21-channel 4K high definition (with 4 input ports) series information for detailed information.
- 15-channel 4K high definition series/15-channel 4K high definition (with 4 input ports) series max supports 15 screens setup. Please refer to 21-channel 4K high definition series/21-channel 4K high definition (with 4 input ports) series information for detailed information.
- 12-channel 4K high definition series/12-channel 4K high definition (with 4 input ports) series max supports 12 screens setup. Please refer to 21-channel 4K high definition series/21-channel 4K high definition (with 4 input ports) series information for detailed information.
- The 16-channel high definition series supports 1×1,1×2,1×3,1×4,4×1,3×1,2×1,2×2,2×3,3×2,2×4,4×2,3×3,3×4,4×3,3×5,5×3,4×4 modes.

Here we use 9-channel high definition series product to continue. The splicing wall interface is shown as below. See Figure 3-21.



Figure 3-21

Step 1 In the main interface, click the Splice button  Splicing Wall on the left pane; you can see system pops up the following interface. See Figure 3-22.

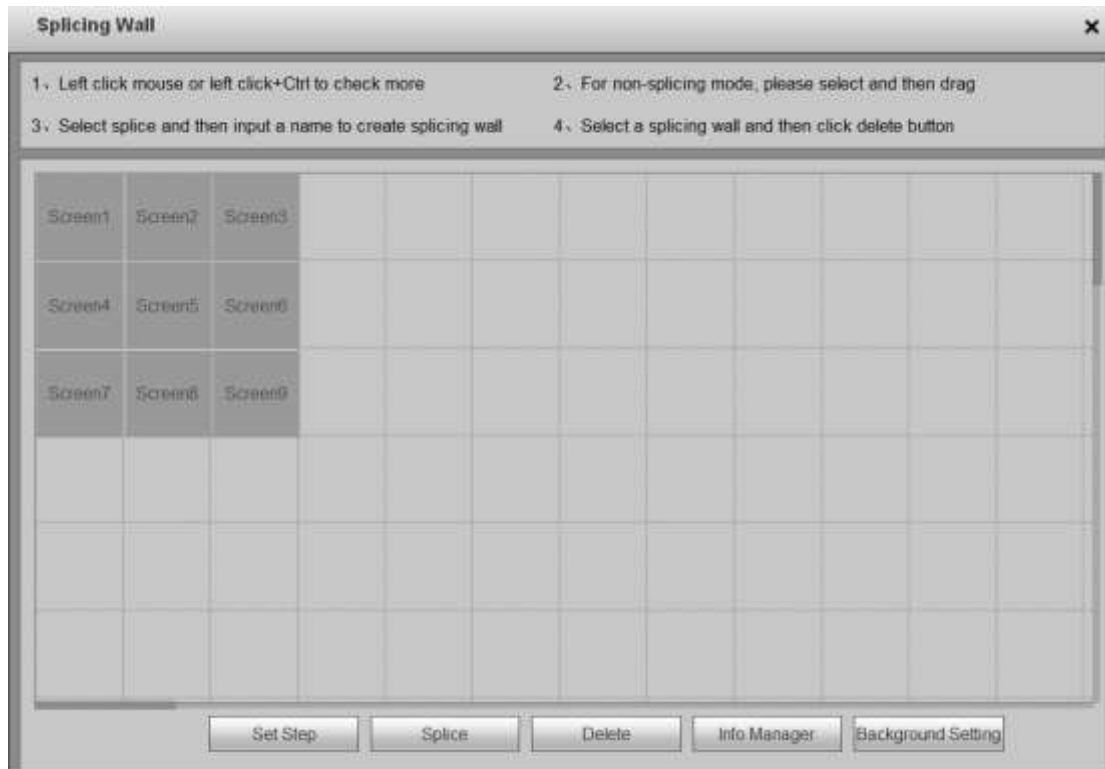

Figure 3-22

- Step 2 Select screens. Left click mouse to select one or left click mouse +Ctrl button to select more screens. See Figure 3-23.
- Step 3 Input customized screen name. Click Save button to save current setup.
Now you can close splicing wall interface and then go back to the main interface.
The splicing wall can be used as a physical screen. It supports 1/4/9/16 split, add/delete device, open/close all-channel monitor, playback (playback is for 1X1 splicing screen only).

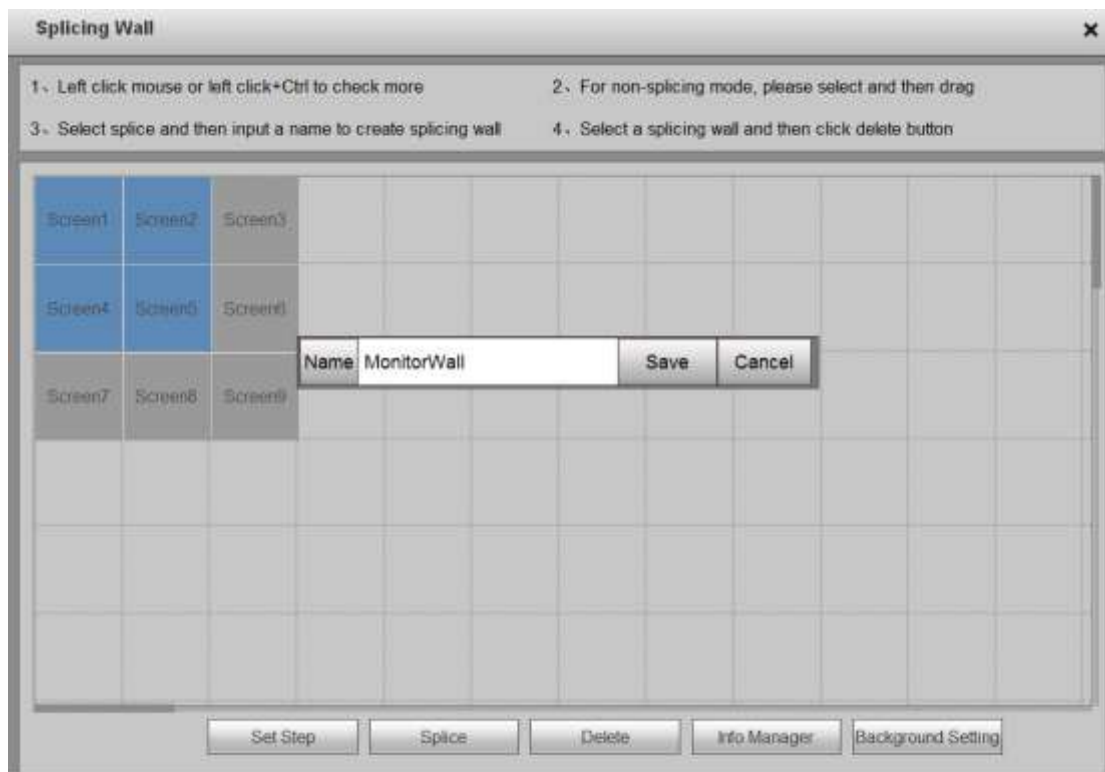

Figure 3-23

3.6.2 Configuring Step



Note

- This function is for 9-channel 4K high definition series/9-channel 4K high definition (with 4 input ports) series product.
- Step value is a parameter of the displayer. Different displayers have different default step values. It is recommended to use the default setup.

On splicing wall setting interface, click Set Step button, you can adjust step and narrow the time error between each screen so that videos on all screens are synchronized. See Figure 3-24.

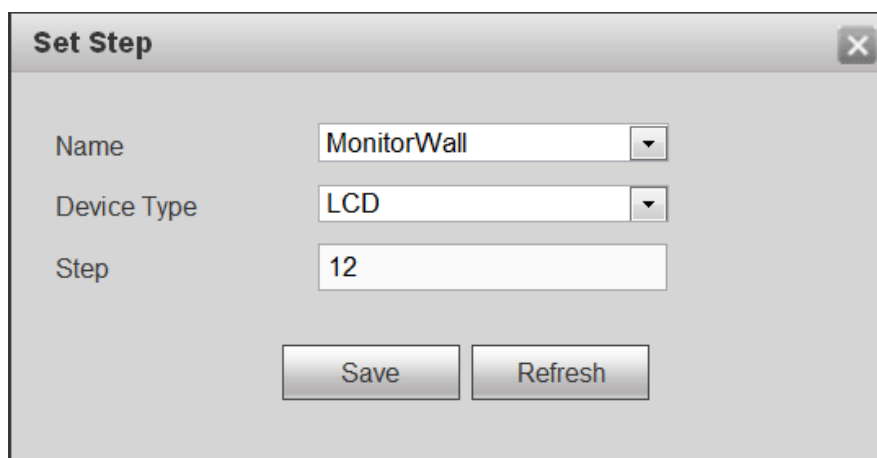



Figure 3-24

3.6.3 Cancel splicing wall

In the main interface, click the Splice button  Splicing Wall on the left pane; you can go to Figure 3-22. Select a splicing wall first and then click  button, you can remove the selected splicing wall.



Note

The corresponding physical screens are off after you created a splicing wall. After you delete the splicing wall, the corresponding physical screens are off too.

3.6.4 Info Manager

In splicing wall setup interface, click Info manager, you can change screen name and ID. See Figure 3-25.

- Control ID: You can set control ID when you are using the network keyboard such as NKB1000.

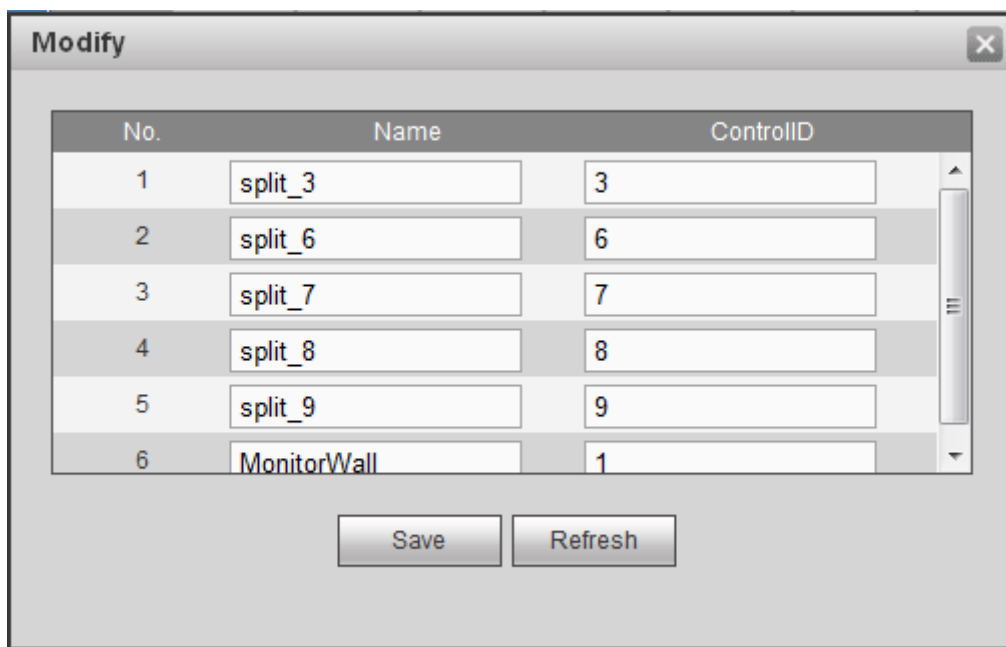

Figure 3-25

3.6.5 Background Setup



Note

This function is for 9-channel 4K high definition series/9-channel 4K high definition (with 4 input ports) series/12-channel 4K high definition series/12-channel 4K high definition (with 4 input ports) series/15-channel 4K high definition series/15-channel 4K high definition (with 4 input ports) series/18-channel 4K high definition series/18-channel 4K high definition (with 4 input ports) series/21-channel 4K high definition series/21-channel 4K high definition (with 4 input ports) series.

Here is for you to set background for the displayed screen.

- Step 1 On the video wall interface, click Splice, you can go to the following interface. See Figure 3-26.

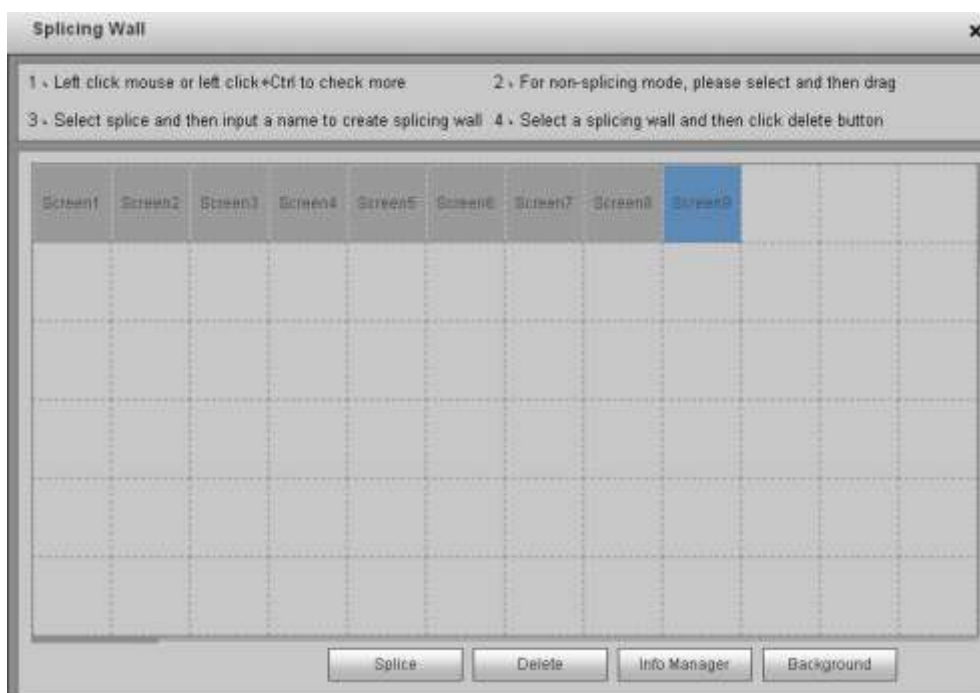

Figure 3-26

- Step 2 Select a screen and then click Background, you can go to the following interface. See Figure 3-27.



Figure 3-27

- Step 3 Select a background image from the dropdown list. If there is no image, please go to Setup->Background (chapter 3.12.7) to add an image.
- Step 4 Check the box to enable this function.
- Step 5 Click OK to complete the setup. Now you can view the background image for current screen.

3.7 Add /Remove Front-end Device

3.7.1 Add Device

Click  at the bottom right corner of the main interface, you can go to the remote device interface. Please refer to chapter 3.12.9 for detailed information.

3.7.2 Delete Device

Click  at the bottom right corner of the main interface, you can go to the remote device interface. Please refer to chapter 3.12.9 for detailed information.

3.8 Decode Channel Setup

Please select the output TV and position on the TV wall interface, and then select the device channel on the device list on the right pane. Double click channel name or drag the channel name to the destination position and then release. See Figure 3-28.



Figure 3-28

Right click channel of the front-end, you can enable main stream or sub stream. See Figure 3-29.

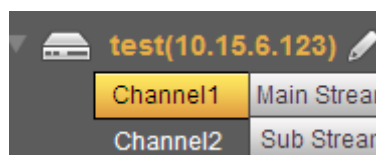



Figure 3-29

- : Open/close sub stream.
- : Open main stream.

- Screen on-off button. : Open. : Close.

3.9 Playback

You can select a device you want to playback and then select the corresponding playback mode. There are two modes: file playback and time playback.



Note

- For 1-channel 4K high definition series, click Playback by file or Playback by time at the bottom right pane, you can enter respective interface. For 9-channel high definition series /16-channel high definition series/1-channel 4K high definition series/4-channel 4K high definition series/9-channel 4K high definition series/9-channel 4K high definition (with 4 input ports) series/12-channel 4K high definition series/12-channel 4K high definition (with 4 input ports) series/15-channel 4K high definition series/15-channel 4K high definition (with 4 input ports) series/18-channel 4K high definition series/18-channel 4K high definition (with 4 input ports) series/21-channel 4K high definition series/21-channel 4K high definition (with 4 input ports) series, click Playback at the bottom right pane to enter Playback by file interface. Select the tab to enter corresponding interface. Here we use 1-channel 4K high definition series product to continue.
- Slight interface maybe found on the user interface.
- Playback function is for private device only (The manufacturer type is private when you are registering the remote device to the system.).
- This function is for 1X1 splicing screen only.

3.9.1 Playback by File

Step 1 Please select an online device first and then select playback by file button. You can see the following interface. See Figure 3-30.



Figure 3-30

Step 2 Please select the decode channel, record type and then select start time/end time, click search button, you can see an interface is shown as below. See Figure 3-31.

 **Note**

Before you search record file, please make sure the network communication is OK. Otherwise the search operation may fail since the device is offline.

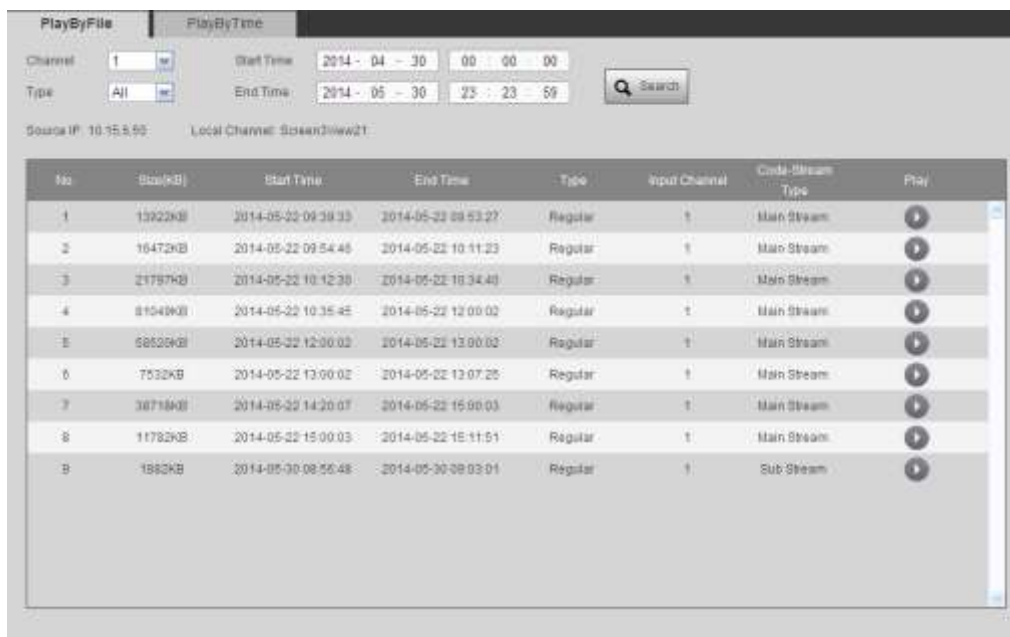

Figure 3-31

Step 3 Select a record file and then click , you can see the following interface. See Figure 3-32.

 **Note**

- System max supports 4-channel playback at the same time.
- System cannot playback the same camera of one device at different channels.

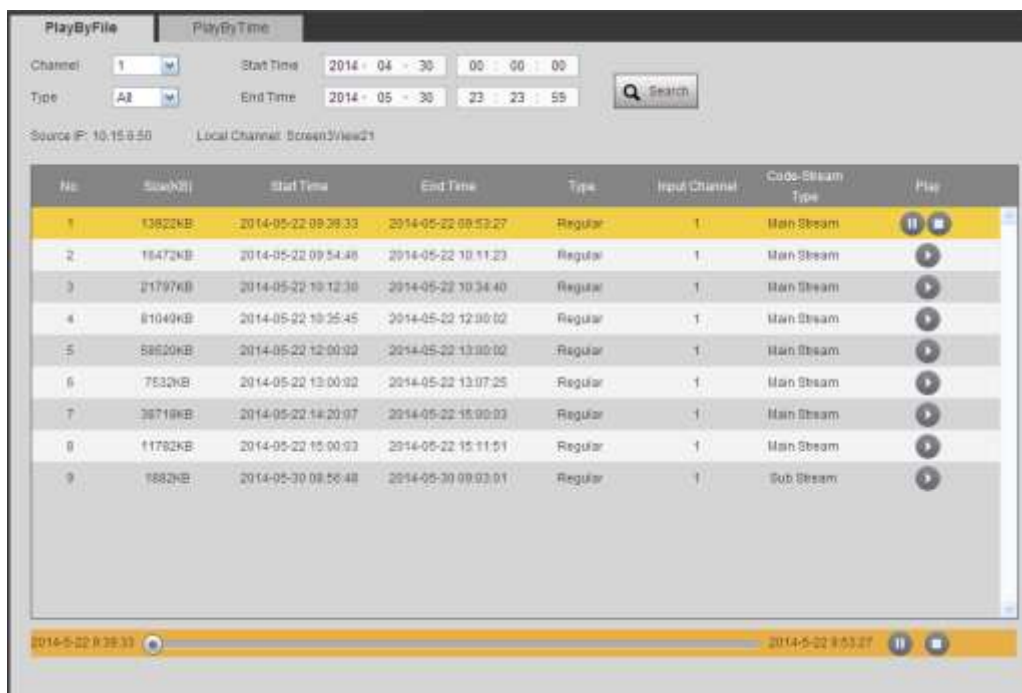

Figure 3-32

Step 4 The main interface is shown as below. See Figure 3-33.

Step 5 Click the process bar to adjust file playback position. Or you can click button to play, pause, and stop.

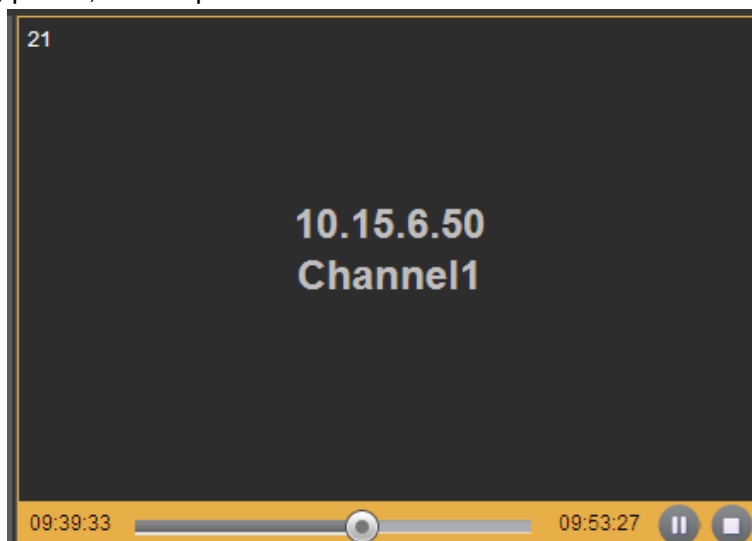

Figure 3-33

Step 6 Double click decode channel, you can view in full screen. The playback bar is shown as below. See Figure 3-34. The three buttons ranges from left to the right are: playback, pause, and stop.



Figure 3-34

3.9.2 Playback by Time

Step 1 Please select an online device first and then select playback by time button, you can see an interface shown as in Figure 3-35.



Figure 3-35

Step 2 Please select corresponding time period and channel, and then click playback button, system can playback automatically. See Figure 3-36.

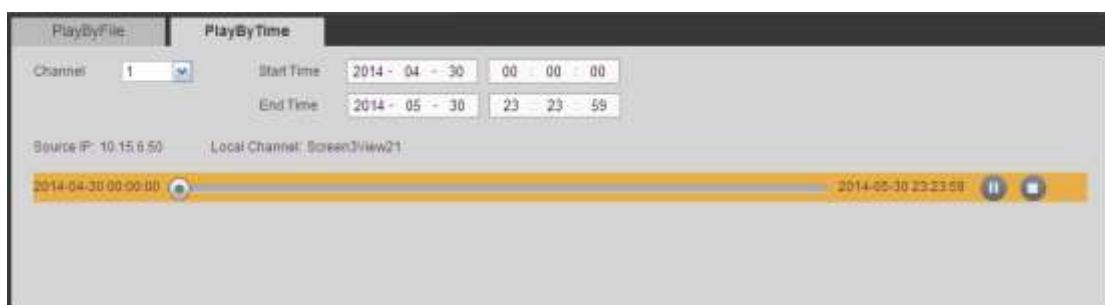

Figure 3-36

Step 3 The playback bar is the same with file playback mode. It is to play, pause, stop playback.

Step 4 Click TV wall button to playback. Refer to chapter 3.9.1 File playback for detailed information.

Note

TV window is shown as black if there is no record in current specified period.

3.10 Scheme Tour

Scheme tour allows you to combine several preview schemes together and you can view one by one at the specified sequence and interval.

Here we use scheme a, scheme b, scheme c to continue.

3.10.1 Add New Scheme

Step 1 One the main menu, select a screen and then set split mode. On the front-end list, double click a device name and then click Save. See Figure 3-37.

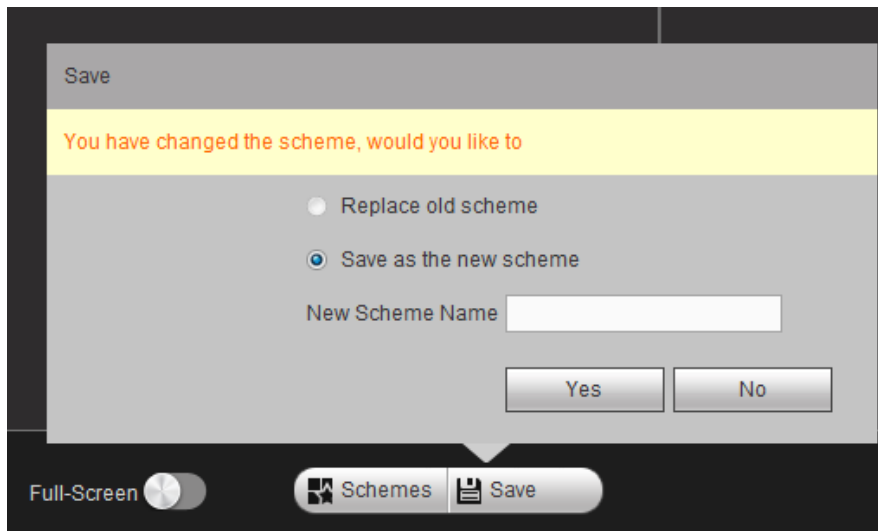
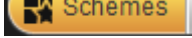

Figure 3-37

- Step 2 Check the box to save current setup as the new scheme (such as scheme a).
- Step 3 Click Yes button.
- Step 4 Repeat the above steps to set another two schemes (such as scheme b, scheme c).

3.10.2 Scheme Manager

- Step 1 On the main interface, click  at the bottom of the interface, you can see the following interface. See Figure 3-38 or Figure 3-39. There are three new schemes.

Note

- For 9-channel high definition series/16-channel high definition series, please refer to Figure 3-38. The rest series interface is shown as in Figure 3-39.
- The following operations are based on Figure 3-38.

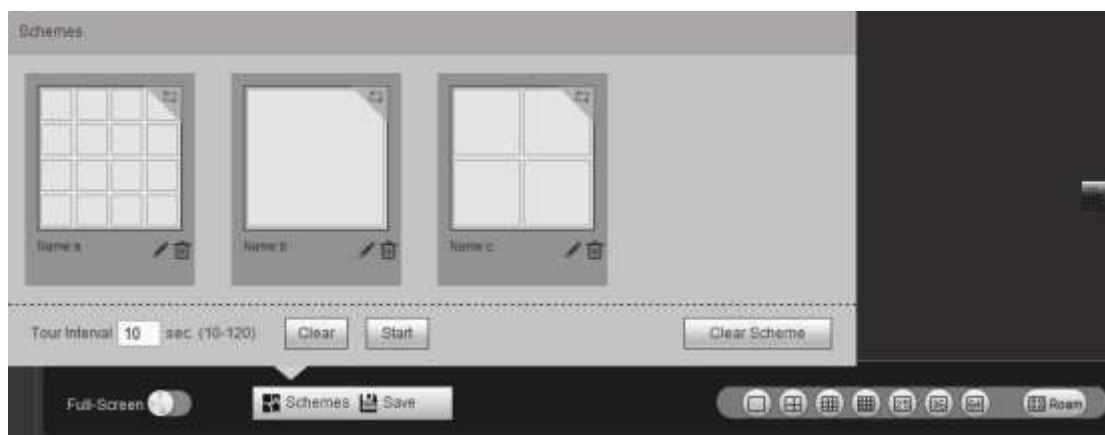

Figure 3-38

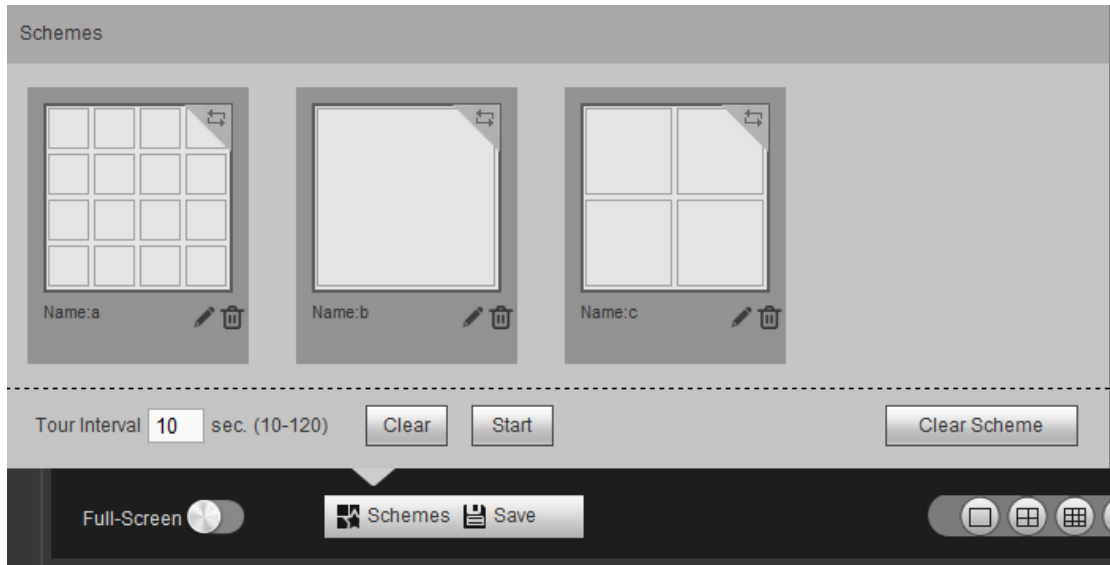



Figure 3-39

Step 2 Click  to select a scheme and then input tour interval such as 10 seconds. Click the top right corner to set tour sequence (1->2->3). See Figure 3-40.

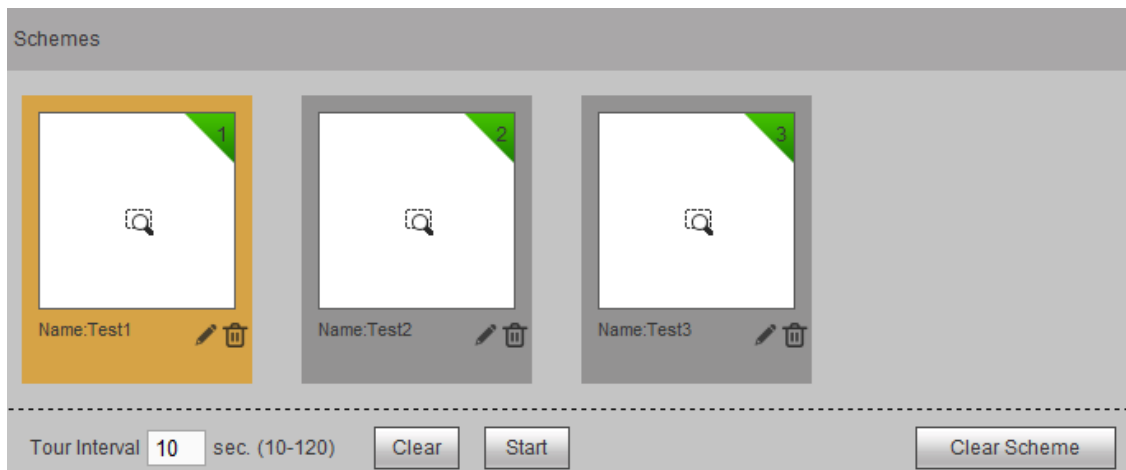





Figure 3-40

- Click  to change scheme name.
- Click  to delete a scheme.
- Click  button to delete all schemes.
- Click Clear to cancel current scheme selection.
- Click  button to start scheme tour.

Step 3 You can see a pop-up window at the bottom right corner of the Web. See Figure 3-41.

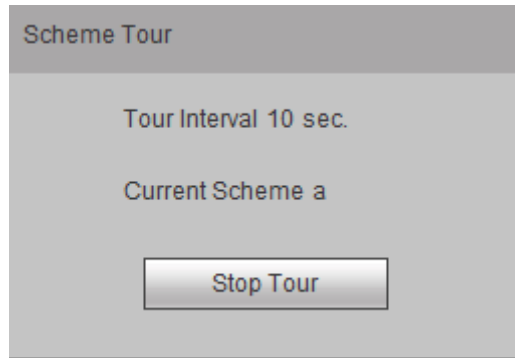

Figure 3-41

Step 4 Click Stop tour button to disable current tour process.

3.10.3 Replace Original Scheme

Step 1 On scheme manager interface, select a scheme first and then refer to chapter 3.10.1 to set a scheme. Click Save button, you can see the following pop-up window. See Figure 3-42.

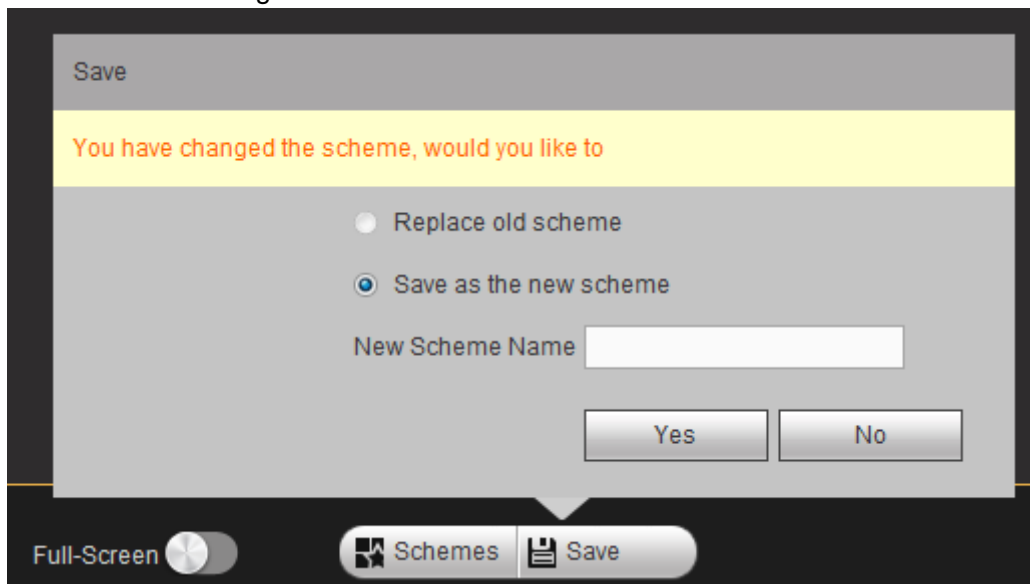

Figure 3-42

Step 2 Check the box to select Save as the new scheme and then click Yes button to exit.

3.11 Decoder

3.11.1 Decode Tour

Here you can set decode output channel and tour channel.

Decode tour means the decode channels of the decoder can bind the channels on the network. It can display the channels by the specified sequence and interval.

Note

The decode tour function is null when you are opening the new screen to roam.

Step 1 On the main menu, from decoder->decode tour; you can see the following interface. See Figure 3-43.

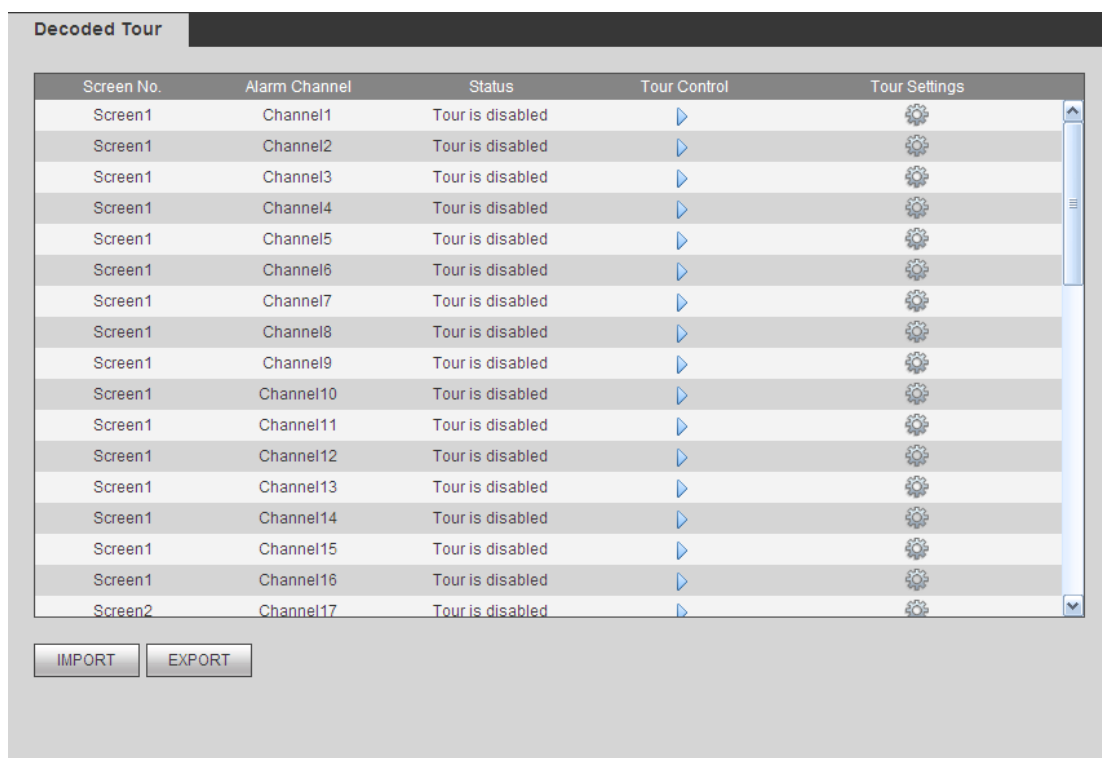



Figure 3-43

Step 2 Double click a channel you want to set or click , you can set channel tour detailed information. See Figure 3-44.

Channel1Detailed Information

Tour Info

Network Signal Local Signal

Protocol Type: Private

Connection Mode: TCP

IP:

Port: 37777

Channel: 1

Code-Stream Type: Main Stream

Username:

Password:

Interval: 10 (10~99999)Second

Add Delete Modify

No.	Manufacturer	IP/URL	Port	Channel	Code-Stream Type	Interval	Delete

Save Refresh

Figure 3-44

Step 3 Set tour information.

- When select Network signal, refer to the following sheet to set parameters.

Parameter	Note
-----------	------

Parameter	Note
Protocol type	It includes: private, Onvif, General, Hikvision.  Note Hikvision protocol is for 1-channel 4K high definition series/1-channel 4K(H.265) high definition series/9-channel 4K high definition series/9-channel 4K high definition (with 4 input ports) series/12-channel 4K high definition series/12-channel 4K high definition (with 4 input ports) series/15-channel 4K high definition series/15-channel 4K high definition (with 4 input ports) series/18-channel 4K high definition series/18-channel 4K high definition (with 4 input ports) series/21-channel 4K high definition series/21-channel 4K high definition (with 4 input ports) series.
Connection mode	For different device modes, the connection mode may vary.
IP	Front-end device IP address.
Port	Default setup is 37777.
Channel	The channel of the front-end device.
Bit stream type	The bit stream type of the tour window. It includes the main stream and the sub stream.
User name	The user name of the remote device.
Password	The password of the remote device.
Interval	The tour interval.

- When select Local Signal; you can see the following interface. See Figure 3-45. Refer to the above sheet to set parameters.

 **Note**

This function is for 4-channel 4K high definition series/9-channel 4K high definition /9-channel 4K high definition (with 4 input ports) series/12-channel 4K high definition (with 4 input ports) series/15-channel 4K high definition (with 4 input ports) series/18-channel 4K high definition (with 4 input ports) series /21-channel 4K high definition (with 4 input ports) series.

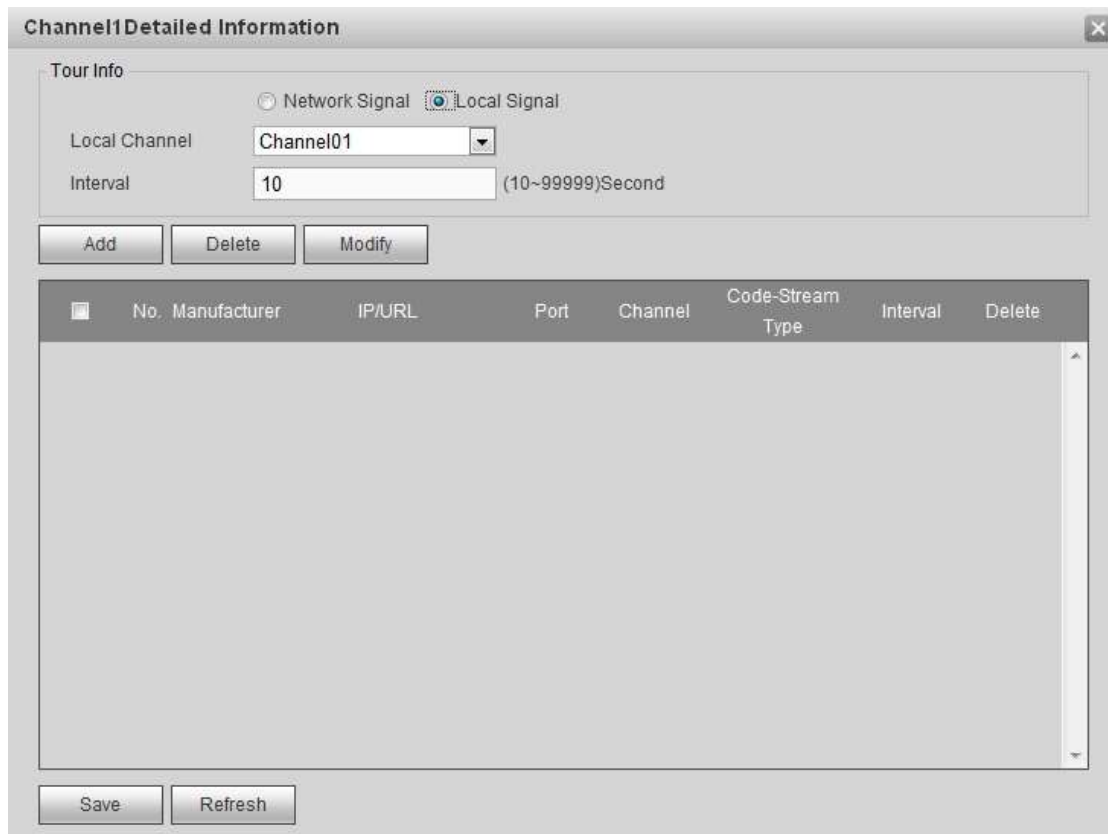



Figure 3-45

Parameter	Note
Local Channel	Please select from the dropdown list.
Interval	It is to set tour interval.

Step 4 Click add button to complete the add operation.

Step 5 Click Save button.

Step 6 Return decode tour interface, select the channel(s) you set and then click  to enable tour.

- Click : Stop tour.
- Click : Pause tour.

3.11.2 Decode Info

Here you can view current decode information such as channel working status, video resolution and frame rate.

Step 1 On the main window, from decoder->decoded info, interface is shown as below. See Figure 3-46.

Channel	Status	Resolution	FPS	Date Flow(kb/s)	Decoded Flow(kb/s)
Channel1	Idle		0	0	0
Channel2	Idle		0	0	0
Channel3	Idle		0	0	0
Channel4	Idle		0	0	0
Channel5	Idle		0	0	0
Channel6	Idle		0	0	0
Channel7	Idle		0	0	0
Channel8	Idle		0	0	0
Channel9	Idle		0	0	0
Channel10	Idle		0	0	0
Channel11	Idle		0	0	0
Channel12	Idle		0	0	0
Channel13	Idle		0	0	0
Channel14	Idle		0	0	0
Channel15	Idle		0	0	0
Channel16	Idle		0	0	0
Channel17	Idle		0	0	0

Figure 3-46

Step 2 View decoding information.

- Status: Current channel working status. There are four statuses: Monitor/Playback/Tour/Idle.
- Resolution: Here you can view video resolution of current channel.
- FPS: You can view the frame rate of current channel.
- Data Flow: You can view the network data flow current channel received.
- Decode flow: You can view the output video flow current channel decoded.

3.11.3 Decode Strategy

It is to set the delay time of decoder in each decode channel, the buffer time is ms.

Step 1 On the main menu, from decoder->decoded policy,

Enter the following interface. See Figure 3-47 or Figure 3-48.

Decoded Policy	
Channel No.	<input type="text" value="1"/>
Decoding buffer time	<input type="text" value="160"/> 80~480 ms
<input type="button" value="Copy"/> <input type="button" value="Save"/> <input type="button" value="Refresh"/>	

Figure 3-47



Figure 3-48

Step 2 Set parameters

- Channel number:
 - ✧ The 1-channel 4K high definition series/1-channel 4K (H.265) high definition series supports 1-16-channel.
 - ✧ The 9-channel high definition series supports 1-48-channel.
 - ✧ The 4-channel 4K high definition series/ 16-channel high definition series supports 1-64-channel.
 - ✧ The 9-channel 4K high definition series/9-channel 4K high definition (with 4 input ports) series supports 1-144 channel.
 - ✧ 12-channel 4K high definition series/12-channel 4K high definition (with 4 input ports) series supports 1-192 channel.
 - ✧ 15-channel 4K high definition series/15-channel 4K high definition (with 4 input ports) series supports 1-240 channel.
 - ✧ 18-channel 4K high definition series/18-channel 4K high definition (with 4 input ports) series supports 1-288 channel.
 - ✧ 21-channel 4K high definition series/21-channel 4K high definition (with 4 input ports) series supports 1-336 channel.
- Decode buffer time: The value ranges from 80ms to 480ms. When the bit streams transmission is not fluent. It is to set the video latency and realtime features. If the decode buffer time is short, the video has the realtime feature. If the decode buffer time is long, the video has the fluent feature.



Note

- For 9-channel high definition series/16-channel high definition series/1-channel 4K high definition series/4-channel 4K(H.265) high definition series/4-channel 4K high definition series/9-channel high definition series/12-channel 4K high definition series /12-channel 4K high definition (with 4 input ports) series/15-channel 4K high definition series/15-channel 4K high definition (with 4 input ports) series/18-channel 4K high definition series/18-channel 4K high definition (with 4 input ports) series/21-channel 4K high definition series/21-channel 4K high definition (with 4 input ports) series product, the value ranges from 80ms to 480ms.

- For 9-channel 4K high definition series/9-channel 4K high definition (with 4 input ports) series product, the value ranges from 80ms to 1000ms.

Step 3 Click the Save button.

3.11.4 Screen No. Overlay

It is for you to overlay device IP and TV number of current channel at the top left corner of current channel output interface.



Note

- This function is for 9-channel high definition series/16-channel high definition series/1-channel 4K high definition series/4-channel 4K(H.265) high definition series/4-channel 4K high definition series/9-channel 4K high definition series/9-channel 4K high definition (with 4 input ports) series/9-channel high definition series/12-channel 4K high definition series /12-channel 4K high definition (with 4 input ports) series/15-channel 4K high definition series/15-channel 4K high definition (with 4 input ports) series/18-channel 4K high definition series/18-channel 4K high definition (with 4 input ports) series/21-channel 4K high definition series/21-channel 4K high definition (with 4 input ports) series product.
- This function is for 1 × 1 splicing wall only.

Step 1 On the main menu, from decoder->screen No. overlay, you can see the following interface. See Figure 3-49.



Figure 3-49

Step 2 Select one or more channels, or click the All channels button, and then click the Save button.

3.11.5 Output Options



Note

This function is for 1-channel 4K high definition series/9-channel high definition series product only.

Here you can set output screen port. Please make sure it is the same as the connected port setup.

Step 1 On the main menu, from decoder->Output options, you can see the following interface. See Figure 3-50.

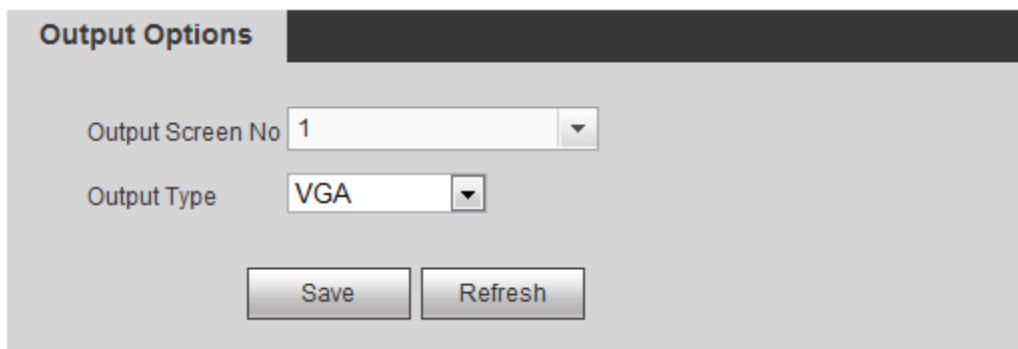

Figure 3-50

- Step 2 Select Screen No. and its corresponding port type (VGA/HDMI) from the dropdown list.
- Step 3 For 1-channel 4K high definition series product, system pops up resolution setup dialogue box, please select from the dropdown list.
- Step 4 Click Save button to complete setup.

3.11.6 Background Color

It is to set screen output background color. There are two options: blue/black. The default setup is blue.

- Step 1 On the main menu, from decoder->Background color, you can see the following interface. See Figure 3-51.



Figure 3-51

- Step 2 It is to set the background color of the screen. Please select from the dropdown list.
- Step 3 Click Save button to complete setup.

3.11.7 Split Line

It is to set decoded channel has split line or not. The default setup is no split line.



Note

There is no split line when you are roaming.

- Step 1 On the main menu, from decoder->Split Line, you can see the following interface. See Figure 3-52.



Figure 3-52

Step 2 Here you can set the split line for the decoded channels. The default setup is No.

Step 3 Click Save button to complete setup.

3.11.8 The Last Frame

After enabled the last frame function, once the device signal is off, the screen displays the decoded channel last frame.



Note

This function is for 1-channel 4K(H.265) high definition series/4-channel 4K high definition series/9-channel 4K high definition series/ 9-channel 4K high definition (with 4 input ports) series/12-channel 4K high definition series/12-channel 4K high definition (with 4 input ports) series/15-channel 4K high definition series/15-channel 4K high definition (with 4 input ports) series/18-channel 4K high definition series/18-channel 4K high definition (with 4 input ports) series/21-channel 4K high definition series/21-channel 4K high definition (with 4 input ports) series.

Step 1 On the main menu, from Decoder->Keep Last frame, you can see the following interface. See Figure 3-53.

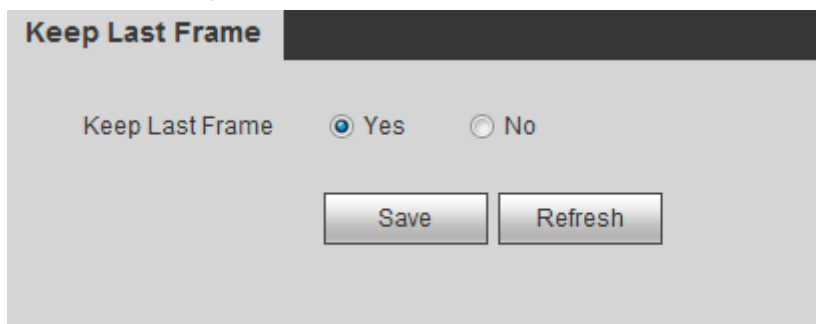

Figure 3-53

Step 2 Check Yes or No to enable/disable the last frame function.

Step 3 Click Save button.

3.11.9 Regular Line

The connected front device has enabled intelligent frame function and the NVS/NVD has enabled displaying function, the device can output tracking panes and automatically follow the specified object. Once the object triggers the alarm, device displays the IVS frame and the object becomes flashing.

Note

This function is for 1-channel 4K (H.265) high definition series only.

Step 1 On the main menu, from Decoder->Regular Line, you can see the following interface. See Figure 3-54.

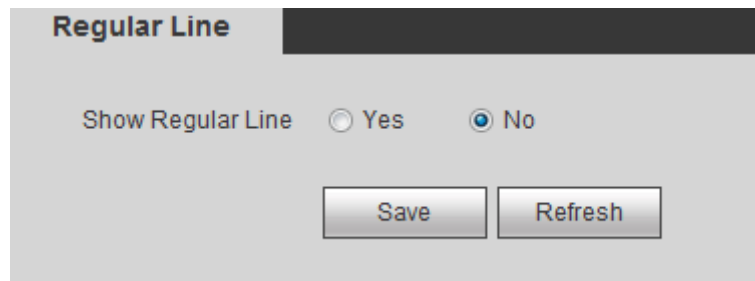

Figure 3-54

Step 2 Check Yes or No to enable/disable the last frame function.

Step 3 Click Save button.

3.12 Setting

3.12.1 General

3.12.1.1 General

It is to set device name, number, language and etc.

Step 1 From Setting->General->General, you can see the following interface. See Figure 3-55.

Step 2 Set parameters.

- Device name: Input customized device name here.
- Device No. Default number is 8. The value ranges from 0 to 998.
- Language: It is to display device language.
- Video standard: It is to display system video standard: PAL/NTSC.

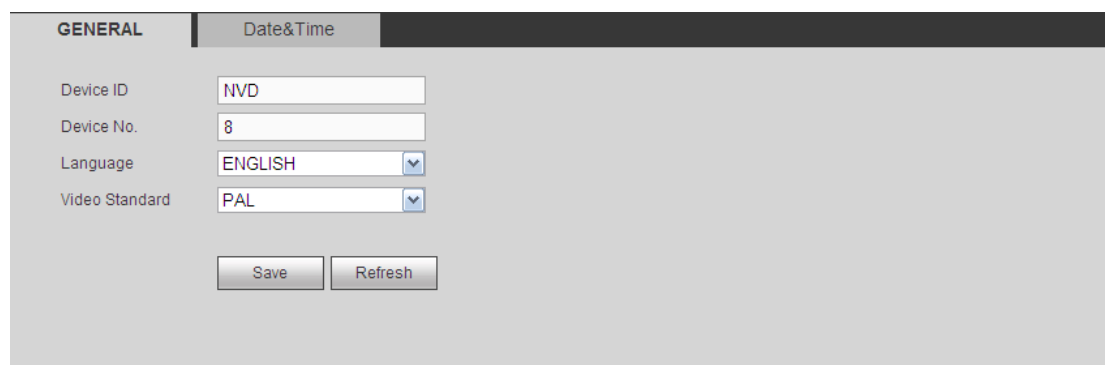

Figure 3-55

Step 3 Click Save button.

3.12.1.2 Date&Time

It is to set device time format, DST setup and etc.

Step 1 From Setting->General->Date&Time, the interface is shown as below. See Figure 3-56.

Step 2 Set parameters.

- Date format: There are three types: YYYY-MM-DD: MM-DD-YYYYY or DD-MM-YYYY.
- Time format: There are two options: 12-hour/24-hour.
- Date separator: There are three denotations to separate date: dot, beeline and solidus.
- System time: It is to set device current date and time. Please click Save to save the setup.
- Sync PC: Click it to sync the time with the PC.
- Time zone: Please select time zone from the dropdown list.
- DST: Here you can set DST time and date. Here you can set start time and end time by setting corresponding week setup or by setting corresponding date setup.
- NTP: It is to set NTP server information.
- Server: It is the IP of the NTP server. Click Manual update, it is to sync device time with the NTP server.
- Port: Right now the NTP supports TCP transmission only. The port is 123.
- Update interval: The value ranges from 0 to 65535 minutes. The 0 means there is no refresh.

The screenshot displays the 'Date&Time' configuration page. At the top, there are tabs for 'GENERAL' and 'Date&Time'. The 'Date&Time' tab is active. The configuration options include:

- Date Format:** A dropdown menu set to 'YYYY MM DD'.
- Time Format:** A dropdown menu set to '24-HOUR'.
- Date Separator:** A dropdown menu set to '-'.
- System Time:** Fields for year (2014), month (05), day (30), hour (14), minute (34), and second (35). A 'Sync PC' button is next to the time fields.
- Time Zone:** A dropdown menu set to 'GMT+08:00'.
- DST:** A checked checkbox. Below it, 'DST Type' has radio buttons for 'Date' and 'Week' (selected).
- Start Time:** Fields for month (Jan), week (Last Week), day (Sunday), and time (00 : 00).
- End Time:** Fields for month (Jan), week (Last Week), day (Sunday), and time (00 : 00).
- NTP:** A checked checkbox.
- Server:** A text input field containing 'NTPServer' and a 'Manual Update' button.
- Port:** A text input field containing '123' with a range '(1~65535)'.
- Update Period:** A text input field containing '10' with a range 'Minute (0~65535)'.

At the bottom of the form, there are 'Save' and 'Refresh' buttons.

Figure 3-56

Step 3 Click Save button.

3.12.2 Network

3.12.2.1 TCP/IP

Here you can set device IP address and DNS server. Please make sure the device can connect to other devices in the same network.

Step 1 From Setting->Network->TCP/IP, TCP/IP interface is shown as below. See Figure 3-57 (1/4/9-channel high definition single-Ethernet card series) and Figure 3-58 (16-channel high definition dual-Ethernet card series).

Step 2 Set parameters.

- Network Mode:
 - ✧ Multiple-address mode: two cards operate separately. You can use the services such as HTTP, RTP service via eth0 or the eth1. Usually you need to set one default card (default setup is eth0) to request the auto network service from the device-end such as DHCP, email, FTP and etc. In multiple-address mode, system network status is shown as offline once one card is offline.
 - ✧ Network fault-tolerance: In this mode, two cards are using one IP address. Usually there is one working card. System can enable alternate card when the master card is malfunction. The system is shown as offline once these two cards are both offline. Please note these two cards shall be in the same LAN.
 - ✧ Load balance: In this mode, two cards are using one IP address. The eth0 and eth1 are both working now and bearing the network load. Their network load are general the same. The system is shown as offline once these two cards are both offline. Please note these two cards shall be in the same LAN.
- Default card: When you are binding several cards, you can set one card as the default working card.

Please note the above function is for dual-Ethernet card series product only.

- Mode: There are two modes: static mode and the DHCP mode.
 - ✧ The IP/sub mask/gateway are null when you select the DHCP mode to auto search the IP.
 - ✧ If you select the static mode, you need to set the IP/submask/gateway manually.
 - ✧ If you select the DHCP mode, you can view the IP/submask/gateway from the DHCP.
 - ✧ If you switch from the DHCP mode to the static mode, you need to reset the IP parameters.

Besides, IP/submask/gateway and DHCP are read-only when the PPPoE dial is OK.

- MAC address: The host in the LAN can get a unique MAC address. It is for you to access in the LAN. It is read-only.
- IP Version: There are two options: IPv4 and IPv6. Right now, system supports these two IP address format and you can access via them.
- IP address: Here you can use up/down button (▲▼) or input the corresponding number to input IP address. Then you can set the corresponding subnet mask the default gateway.
- Default gateway: Here you can input the default gateway. Please note system needs to check the validity of all IPv6 addresses. The IP address

and the default gateway shall be in the same IP section. That is to say, the specified length of the subnet prefix shall have the same string.

- Preferred DNS server: DNS server IP address.
- Alternate DNS server: DNS server alternate address.

**Note**

For IPv6, the IP address, default gateway, preferred DNS, alternate DNS shall be 128-digit and shall be left in blank.

TCP/IP	Port	HTTPS
Mode	<input checked="" type="radio"/> Static <input type="radio"/> DHCP	
MAC Address	90 . 02 . A9 . 05 . D6 . E4	
IP Version	IPv4	
IP Address	10 . 15 . 6 . 144	
Subnet Mask	255 . 255 . 0 . 0	
Default Gateway	10 . 15 . 0 . 1	
Preferred DNS	8 . 8 . 8 . 8	
Alternate DNS	8 . 8 . 4 . 4	
<input type="button" value="Save"/> <input type="button" value="Refresh"/>		

Figure 3-57

TCP/IP	Port	HTTPS
Network Mode	Multi-address	
Default Card	Ethernet Card1	
Ethernet Card	Ethernet Card1	Default Card
Mode	<input checked="" type="radio"/> Static <input type="radio"/> DHCP	
MAC Address	20 . 32 . 04 . 01 . 50 . 37	
IP Version	IPv4	
IP Address	171 . 5 . 14 . 51	
Subnet Mask	255 . 255 . 255 . 0	
Default Gateway	171 . 5 . 14 . 1	
Preferred DNS	8 . 8 . 8 . 8	
Alternate DNS	8 . 8 . 4 . 4	
<input type="button" value="Save"/> <input type="button" value="Refresh"/>		

Figure 3-58

Step 3 Click Save button.

3.12.2.2 Port

Step 1 From Setting->Network->port, port interface is shown as below. See Figure 3-59.

Step 2 Set parameters.

- Max connection: It is the max Web connection for the same device. The value ranges from 1 to 120. The default setup is 120.
- TCP port: The default value is 37777. You can input the actual port number if necessary.
- UDP port: The default value is 37778. You can input the actual port number if necessary.
- HTTP port: The default value is 80. You can input the actual port number if necessary.
- HTTPS: The default value is 443. You can input the actual port number if necessary.

TCP/IP	Port	HTTPS
Max Connection	<input type="text" value="10"/>	(0~10)
TCP Port	<input type="text" value="37777"/>	(1025~65535)
UDP Port	<input type="text" value="37778"/>	(1025~65535)
HTTP Port	<input type="text" value="80"/>	(1~65535)
HTTPS Port	<input type="text" value="443"/>	(128~65535)
<input type="button" value="Save"/> <input type="button" value="Refresh"/>		

Figure 3-59

Step 3 Click Save button.

3.12.2.3 HTTPS

In this interface, you can set to make sure the PC can successfully login via the HTTPS. It is to guarantee communication data security. The reliable and stable technology can secure the user information security and device safety. See Figure 3-60.



Note

- You need to implement server certificate again if you have changed device IP.
- You need to download root certificate if it is your first time to use HTTPS on current PC.

TCP/IP	Port	HTTPS
<input type="button" value="Create Server Certificate"/> <input type="button" value="Download Root Certificate"/>		

Figure 3-60

3.12.3 RS232

3.12.3.1 RS232



Note

- 1-channel 4K high definition series/1-channel 4K(H.265) high definition series/9-channel 4K high definition series/9-channel 4K high definition (with 4 input ports) series/12-channel 4K high definition (with 4 input ports) series/15-channel 4K high definition series/15-channel 4K high definition (with 4 input ports) series/18-channel 4K high definition series/18-channel 4K high definition (with 4 input ports) series/21-channel 4K high definition series/21-channel 4K high definition (with 4 input ports) series product has no RS232 function.

- For general COM, default setup: Baud rate: 115200(read-only), data bit: 8, stop bit: 1, parity: none.

Step 1 From Setting->RS232->RS232, you can see RS232 interface is shown as below. See Figure 3-61.

Step 2 Set parameters.

- Function: There are various devices for you to select. Console is for you to use the COM or mini-end software to upgrade or debug the program. The control keyboard is for you to control the device via the special keyboard. Transparent COM (adapter) is to connect to the PC to transfer data directly. Protocol COM is for card overlay function. Network keyboard is for you to use the special keyboard to control the device. PTZ matrix is to connect to the peripheral matrix control.
- Baud rate: You can select proper baud rate. The default setup is 115200.
- Data bit: You can select proper data bit. The value ranges from 5 to 8(default).
- Stop bit: There are three values: 1(default)/1.5/2.
- Parity: There are five choices: none (default)/odd/even/space/mark.

Label	Value
Function	Console
Baud Rate	115200
Data Bit	8
Stop Bit	1
Parity	None

Buttons: Save, Refresh

Figure 3-61

3.12.3.2 Transfer COM

Step 1 From Setting->RS232->transfer COM, you can see the interface is shown as in Figure 3-62.

Step 2 After you input local COM and remote COM information, you can control the analog PTZ camera.

Step 3 Click the Add button to complete.



Note

The local COM and the remote COM parameter shall be the same; otherwise you cannot control the analog PTZ camera!

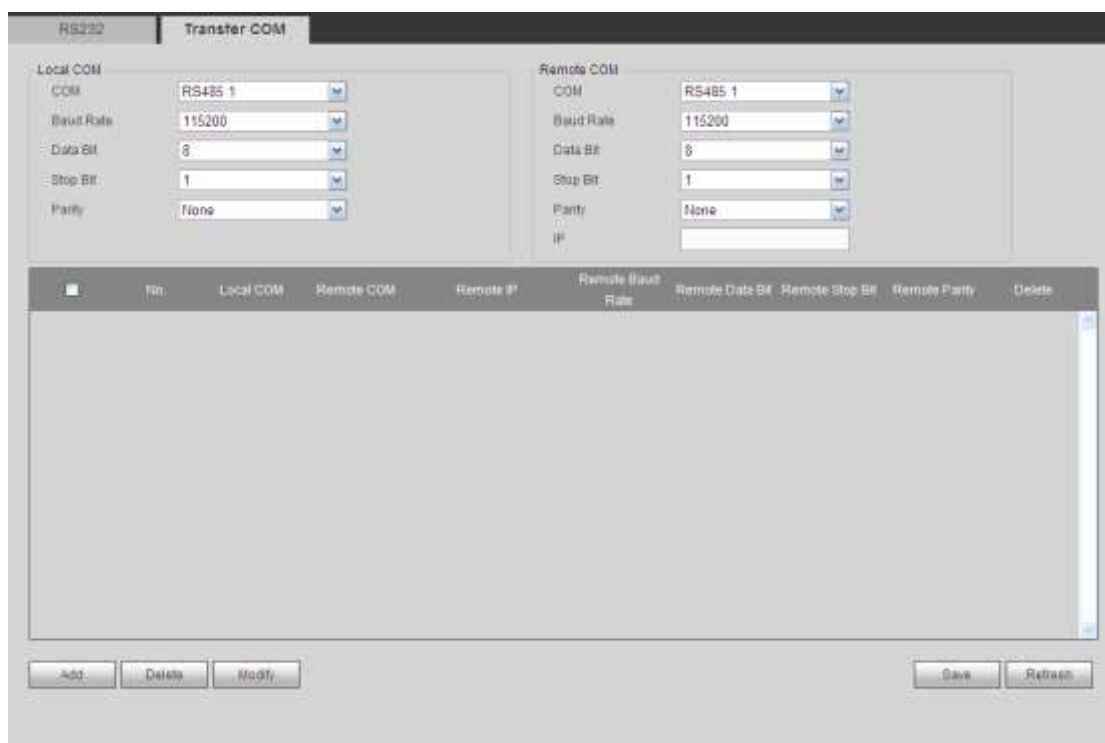

Figure 3-62

Transparent Forwarding Connection

Connect speed dome to encoder or DVR via RS485. The decoder can add encoder or DVR via network. Connect network keyboard or DVR to the decoder via RS485. See Figure 3-63.

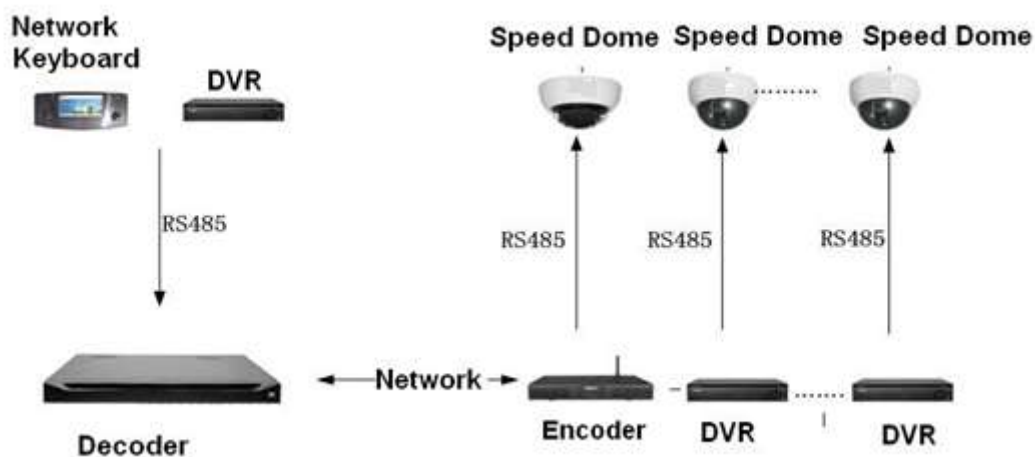

Figure 3-63



Caution

- The dial switch address of the analog speed domes shall not be the same.

- After you connected the analog speed dome to the encoder via RS485, please connect the corresponding AB cable. See Figure 3-64.



Figure 3-64

- Please note Figure 3-64 is for 1-channel 4K high definition series/1-channel 4K(H.265) high definition series/4-channel 4K high definition series/9-channel high definition series/16-channel high definition series/12-channel 4K high definition series/12-channel 4K high definition (with 4 input ports) series/15-channel 4K high definition series/15-channel 4K high definition (with 4 input ports) series/18-channel 4K high definition series/18-channel 4K high definition (with 4 input ports) series/21-channel 4K high definition series/21-channel 4K high definition (with 4 input ports) series only.
- When you set the PTZ setup of the network keyboard or the DVR, please make sure the baud rate setup shall be the same with the setup of the device.
- When you set the PTZ setup of the network keyboard, DVR, encoder, please make sure the protocol setup shall be the same.

Transparent Forwarding Operation Steps

- Step 1 Set analog speed dome. Set the baud rate of the analog speed dome. When the 5/6 is up, the baud rate is 9600. When the 5 is down and 6 is up, the baud rate is 4800. When the 5 is up and 6 is down, the baud rate is 2400. When the 5/6 is down, the baud rate is 1200. Here we set baud rate as 2400.
- Step 2 Set encoder or DVR. When you connect analog speed dome to the encoder or DVR via RS485, you need to set PTZ setup. See Figure 3-65.



Figure 3-65

Step 3 Set decoder. Please refer to chapter 3.13.3 transparent forwarding to set.

Step 4 Connect network keyboard or DVR to the decoder via RS485.

✧ **About network keyboard setup**

From user menu-remote control, input 0+PT to go to PTZ setup. Here you can set protocol, address, baud rate, data bit, stop bit, parity and etc. See Figure 3-66.

 **Note**

When you connect network keyboard to decoder via RS485, please make sure the network keyboard setup is the same as the PTZ setup of the encoder. Otherwise you cannot control.

PAN/TILT/ZOOM

PROT	PELCO D
Address	1
Baudrate	2400
Data Bit	8
Stop Bit	1
Parity	None

Figure 3-66

✧ **About DVR Setup**

From the main menu, System->PTZ, you can set corresponding baud rate, protocol, address, data bit, stop bit, parity and etc.

- Step 5 After you set, please click the corresponding network keyboard or DVR input channel, you can go to the PTZ interface to control the network speed dome PTZ operation.

3.12.3.3 Screen Control

 **Note**

This function is for 4-channel 4K high definition/ 9-channel 4K high definition series/ 9-channel 4K high definition (with 4 input ports) series/12-channel 4K high definition series/12-channel 4K high definition (with 4 input ports) series/15-channel 4K high definition series/15-channel 4K high definition (with 4 input ports) series/18-channel 4K high definition series/18-channel 4K high definition (with 4 input ports) series/21-channel 4K high definition series/21-channel 4K high definition (with 4 input ports) series product.

Before the operation, please connect the RS232 port of the RJ45 port of the device to the RJ45 port of the screen.

Step 1 From Setting->RS232->Screen control, you can go to the following interface.

See Figure 3-67.

Step 2 Set parameters.

- Name: The corresponding TV wall.
- COM: Display device COM.



Note

This function is for 9-channel 4K high definition series/ 9-channel 4K high definition (with 4 input ports) series/12-channel 4K high definition series/12-channel 4K high definition (with 4 input ports) series/15-channel 4K high definition series/15-channel 4K high definition (with 4 input ports) series/18-channel 4K high definition series/18-channel 4K high definition (with 4 input ports) series/21-channel 4K high definition series/21-channel 4K high definition (with 4 input ports) series only.

- Device type: It is to display device type such as LCD, DLP.
- Control protocol: It is the control protocol of the display device.
- Baud rate: Baud rate of the communication COM protocol. The default setup is 115200.
- Data bit: Data bit of the communication COM protocol. The setup is from 5 to 8. The default setup is 8.
- Stop bit: Stop bit of the communication COM protocol. The setup includes 1, 1.5, 2. The default setup is 1.
- Parity: Parity value of the communication COM protocol. It includes odd/even/space/none.
- Address code: It is corresponding to the address code of display device.
- Screen No.: It is the corresponding screen number.

row column	Address Code	Screen No.	Screen ControlID
1_1	11	1	1

Figure 3-67

3.12.4 Alarm

3.12.4.1 Alarm

Before the operation, please connect the alarm input and alarm output (light, buzzer and etc.)

Note

The 16-channel high definition series product does not support alarm function.

Step 1 From Setting->Alarm->Alarm, the alarm interface is shown as below. See Figure 3-68 or Figure 3-69.

Step 2 Set parameters.

- Enable: You need to draw a circle here so that system can detect the alarm signal.
- Alarm in: Here is for you to select channel number.
- Type: Normal open or normal close.
- Period: Click set button, you can see an interface is shown as in Figure 3-70. There are max 6 periods in one day.
- Alarm Out: Enable alarm activation function. You need to select alarm output port so that system can activate corresponding alarm device when alarm occurs.
- Anti-dither: Device only record one alarm event during the anti-dither period. The value ranges from 0 second to 15 seconds.
- Latch: System can delay the alarm output for specified time after alarm ended. The value ranges from 10 seconds to 300 seconds.
- Tour: Check the box here to enable this function. It is to set main TV output of the tour channel when an alarm signal occurred.

Note

This function is for 1-channel 4K high definition series/ 1-channel 4K (H.265) high definition series /4-channel 4K high definition series.

- Scheme tour: Check the box here to enable scheme tour function. System can enable scheme tour function when an alarm occurred.

Note

This function is for 4-channel high definition series/9-channel high definition series/9-channel 4K high definition series/9-channel 4K high definition (with 4 input ports) series/12-channel 4K high definition series/12-channel 4K high definition (with 4 input ports) series/15-channel 4K high definition series/15-channel 4K high definition (with 4 input ports) series/18-channel 4K high definition series/18-channel 4K high definition (with 4 input ports) series/21-channel 4K high definition series/21-channel 4K high definition (with 4 input ports) series.

- Copy: It is a shortcut menu button. You can copy current channel setup to one or more (all) channels.

- Save: You can click save button after you complete setup for one channel, or you can complete the whole setups and then click save button.
- Refresh: Click this button to get device latest configuration information.

The screenshot shows the 'Alarm Info' configuration page. It features a 'Setup' button at the top left. Below it, there are several configuration options:

- Enable: A dropdown menu showing '1'.
- Type: A dropdown menu showing 'Normal Open'.
- Period: A dropdown menu showing '1'.
- Anti-dither: An input field with the value '5' and the unit 'Second(0-15)'.
- Alarm Out: A row of checkboxes numbered 1 through 8. Box '1' is checked.
- Latch: An input field with the value '10' and the unit 'Second(10-300)'.
- Tour: A grid of checkboxes numbered 1 through 48. Box '1' is checked.

 At the bottom of the form are three buttons: 'Copy', 'Save', and 'Refresh'.

Figure 3-68

The screenshot shows the 'Alarm Info' configuration page. It features a 'Setup' button at the top left. Below it, there are several configuration options:

- Enable: A dropdown menu showing '1'.
- Type: A dropdown menu showing 'Normal Open'.
- Period: A dropdown menu showing '1'.
- Anti-dither: An input field with the value '5' and the unit 'Second(0-15)'.
- Alarm Out: A row of checkboxes numbered 1 through 4. Box '1' is checked.
- Latch: An input field with the value '10' and the unit 'Second(10-300)'.
- Scheme Tour: Three checkboxes labeled 'Test1', 'Test2', and 'Test3', all of which are unchecked.

 At the bottom of the form are three buttons: 'Copy', 'Save', and 'Refresh'.

Figure 3-69

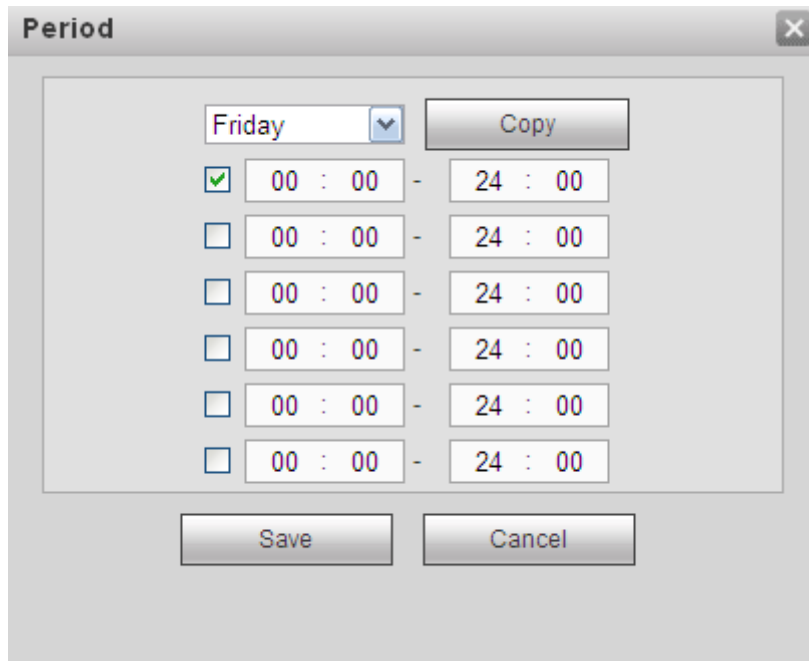

Figure 3-70

3.12.4.2 Alarm Info

Step 1 From Setting->Alarm->Alarm info, alarm info interface is shown as in Figure 3-71.

Step 2 Set parameters.

- External alarm: It is an alarm from external alarm device.
- DSP alarm: It is video format alarm. For example, your decoder is PAL while you connected front-end device is NTSC and its resolution is less than D1, it can generate a DSP alarm.



Note

1-channel 4K(H.265) high definition series/1-channel 4K(H.265) high definition series/9-channel 4K high definition (with 4 input ports) series/12-channel 4K high definition series /12-channel 4K high definition (with 4 input ports) series/15-channel 4K high definition series/15-channel 4K high definition (with 4 input ports) series/18-channel 4K high definition series/18-channel 4K high definition (with 4 input ports) series/21-channel 4K high definition series/21-channel 4K high definition (with 4 input ports) series do not support this function.

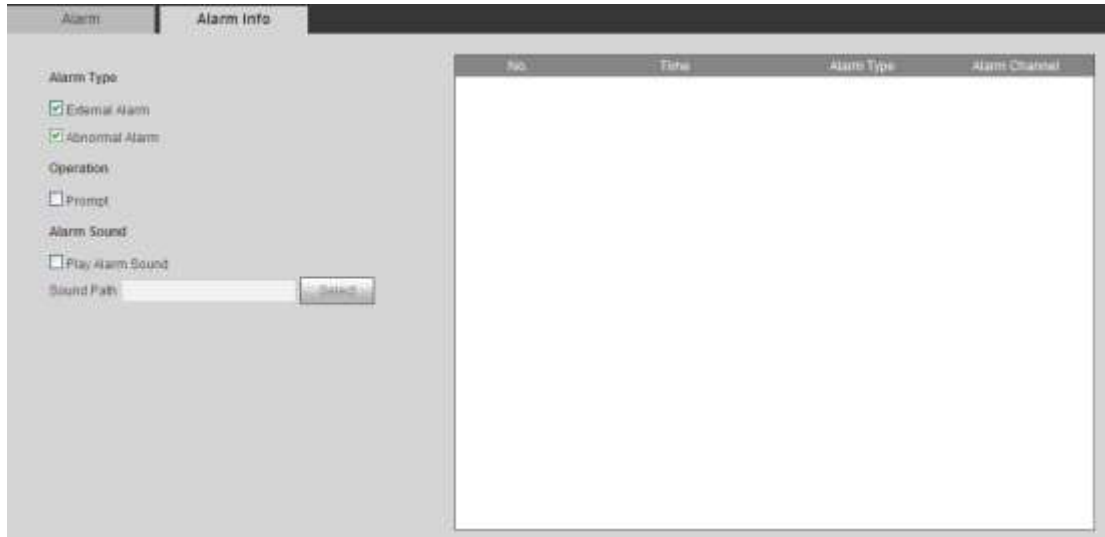

Figure 3-71

3.12.5 Resolution

It is to set the resolution of the output screen.

Step 1 From Setting->Resolution, the resolution interface is shown as below. See Figure 3-72.

Step 2 Select screen number.

- Screen No.: Select screen number from the dropdown list.



Note

This function is for 9-channel 4K high definition series/9-channel 4K high definition (with 4 input ports) series/12-channel 4K high definition series/12-channel 4K high definition (with 4 input ports) series/15-channel 4K high definition series/15-channel 4K high definition (with 4 input ports) series/18-channel 4K high definition series/18-channel 4K high definition (with 4 input ports) series/21-channel 4K high definition series/21-channel 4K high definition (with 4 input ports) series only.

Step 3 Set decoder resolution.

It refers to the screen output resolution. Right now there are six options: 3840×2160, 2560×1600, 1920×1080, 1280×1024, 1280×720, 1024×768.

- 1/4-channel 4K high definition series/9-channel 4K high definition series/9-channel 4K high definition (with 4 input ports) series/12-channel 4K high definition series/12-channel 4K high definition (with 4 input ports) series/15-channel 4K high definition series/15-channel 4K high definition (with 4 input ports) series/18-channel 4K high definition series/18-channel 4K high definition (with 4 input ports) series/21-channel 4K high definition series/21-channel 4K high definition (with 4 input ports) series product supports 3840×2160 extra high definition output.
- 1-channel 4K(H.265) high definition series /9-channel 4K high definition series/9-channel 4K high definition (with 4 input ports) series/12-channel 4K high definition series/12-channel 4K high definition (with 4 input ports)

series/15-channel 4K high definition series/15-channel 4K high definition (with 4 input ports) series/18-channel 4K high definition series/18-channel 4K high definition (with 4 input ports) series/21-channel 4K high definition series/21-channel 4K high definition (with 4 input ports) series product supports 2560×1600 definition output.

- 9-channel 4K high definition series/9-channel 4K high definition (with 4 input ports) series uses each three screens as one group (screen 1 to screen 3, screen 4 to screen 6, screen 7 to screen 9.)
- 12-channel 4K high definition series/12-channel 4K high definition (with 4 input ports) series uses each three screens as one group (screen 1 to screen 3, screen 4 to screen 6, screen 7 to screen 9, screen 10 to screen 12.)
- 15-channel 4K high definition series/15-channel 4K high definition (with 4 input ports) series uses each three screens as one group (screen 1 to screen 3, screen 4 to screen 6, screen 7 to screen 9, screen 10 to screen 12, screen 13 to screen 15.)
- 18-channel 4K high definition series/18-channel 4K high definition (with 4 input ports) series uses each three screens as one group (screen 1 to screen 3, screen 4 to screen 6, screen 7 to screen 9, screen 10 to screen 12, screen 13 to screen 15, screen 16 to screen 18.)
- 21-channel 4K high definition series/21-channel 4K high definition (with 4 input ports) series product uses each three screens as one group (screen 1 to screen 3, screen 4 to screen 6, screen 7 to screen 9, screen 10 to screen 12, screen 13 to screen 15, screen 16 to screen 18. screen 19 to screen 21.)
- In each group, max only two screens support 3840×2160 extra high definition, the last screen max supports 2560×1600.
- In each group, these three screens cannot be set as 3840×2160 at the same time. Otherwise, you can see “failed to set resolution” dialogue box.

Figure 3-72

Step 4 Click Save button to complete the setup.

3.12.6 Signal Adjustment

It is to set connected screen hue, brightness, contrast. It can adjust the connected analog signal output black edge.

Note

This function is for 9-channel 4K high definition series/9-channel 4K high definition (with 4 input ports) series/12-channel 4K high definition series/12-channel 4K high definition (with 4 input ports) series/15-channel 4K high definition series/15-channel 4K high definition (with 4 input ports) series/18-channel 4K high definition series/18-channel 4K high definition (with 4 input ports) series/21-channel 4K high definition series/21-channel 4K high definition (with 4 input ports) series.

3.12.6.1 Output

It is to adjust the screen hue, brightness, contrast connected to the output port.

From Setting->Signal Adjust->Output, the output interface is shown as below. See Figure 3-73.

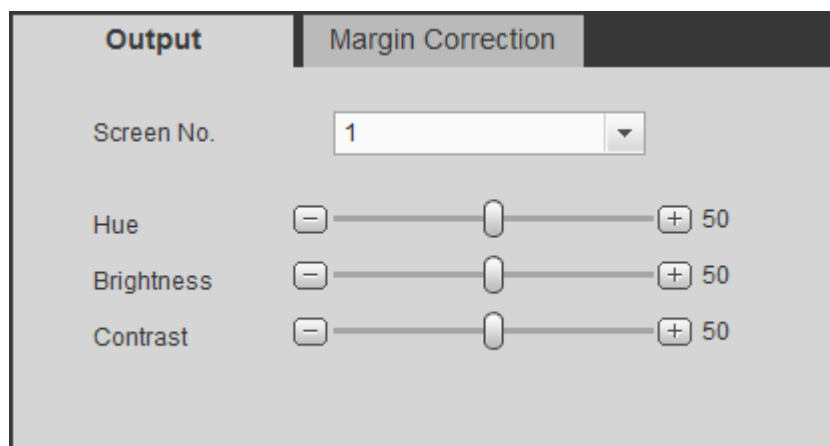

Figure 3-73

3.12.6.2 Margin Correction

It is to adjust the connected analog signal output black edge.

From Setting->Signal Adjust->Margin Correction, the output interface is shown as below. See Figure 3-74.

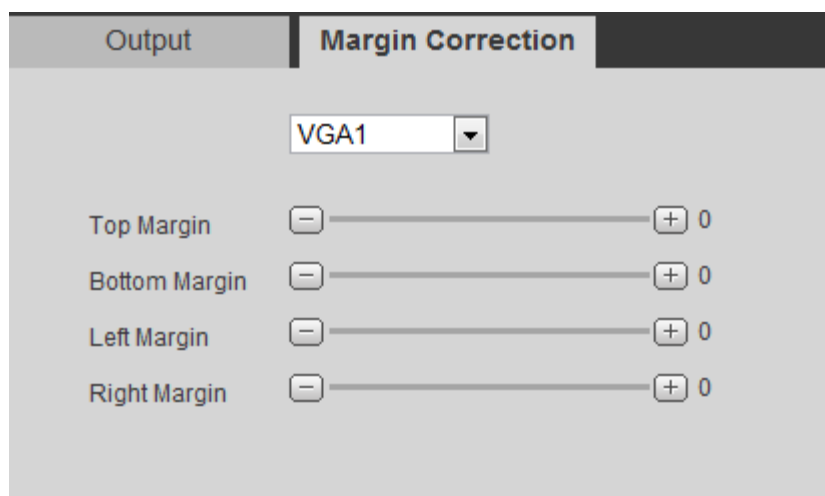

Figure 3-74

Select output port and then set screen margin of the decode.

3.12.7 Background

Note

This function is for 9-channel 4K high definition series/9-channel 4K high definition (with 4 input ports) series/12-channel 4K high definition series/12-channel 4K high definition (with 4 input ports) series/15-channel 4K high definition series/15-channel 4K high definition (with 4 input ports) series/18-channel 4K high definition series/18-channel 4K high definition (with 4 input ports) series/21-channel 4K high definition series/21-channel 4K high definition (with 4 input ports) series.

Here is for you to upload .jpg image. The uploaded image can work at the background. For detailed information, please refer to chapter 3.6.5 Background setup.

Step 1 From Setting->Background, the background interface is shown as below. See Figure 3-75.

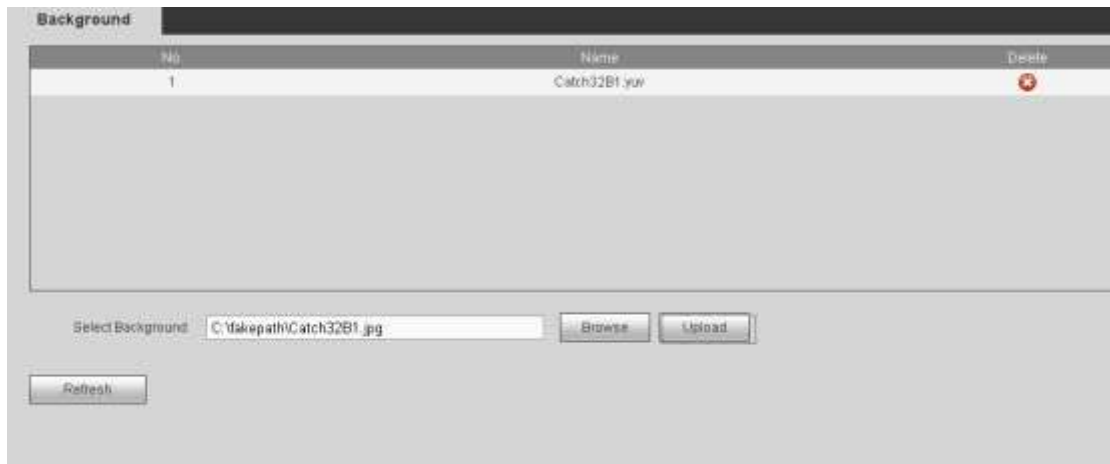



Figure 3-75

Step 2 Click Browse to select an image (.jpg file). Please note system max supports upload 10 images at the same time. Each image size shall not be more than 32M.

Step 3 Click Upload to begin the process.

Step 4 You can view the uploaded image(s) at the list after successful operation. The extension name is .yuv.

- Click  to delete an image.
- Click Refresh to view latest image list.

3.12.8 Account

From Setting->Account, here you can add, remove user or modify password. See Figure 3-76.

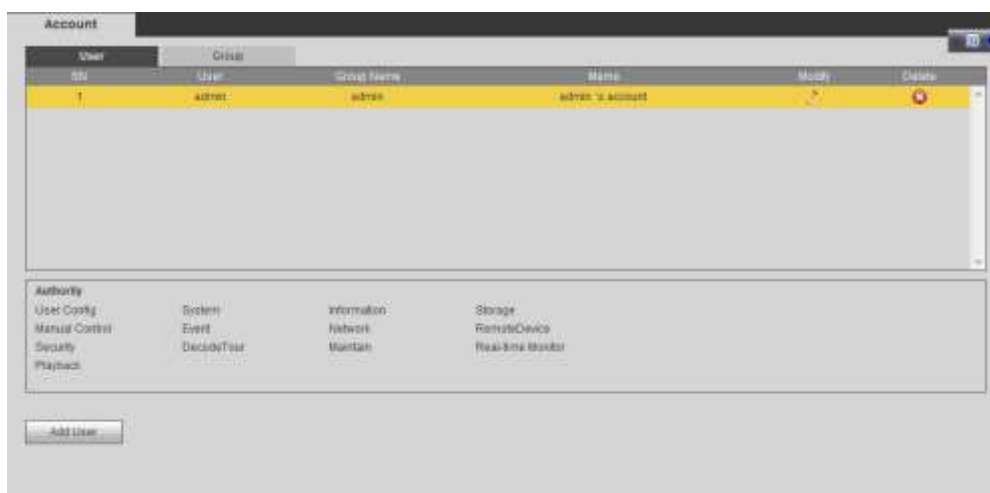

Figure 3-76

Add User

Click add user button, the interface is shown as in Figure 3-77.

Please input the user name, password, and confirm the password, select the group it belongs to from the dropdown list. Check the reusable button so that multiple users can use the same account to login at the same time.

Then you can check the corresponding rights for current user.

For convenient user management, usually we recommend the general user right is lower than the admin account.

Click Save button to complete the setup.

Add User

User Name

Reuseable

Password

Low Middle High

Confirm Password

Group

Memo

Authority

System

- All
- Shutdown
- Account
- Query Log Info
- Auto Maintain
- Alarm Setup
- Remote Device
- Real-time Monitor
- System Info View
- Clear Log
- General Setup
- Default
- Playback
- System Config
- System Update
- Network Setup
- Decoded Tour

Save Cancel

Figure 3-77

Modify User

In Figure 3-76, Click Modify button; you can change current user memory information, group, password and authorities. See Figure 3-78.

Figure 3-78

Modify Password

In Figure 3-78, check Modify password button, please input old password and then input the new password twice to complete the setup. Click OK button to save.



Note

- The password ranges from 8 to 32 digitals. It can contain letters, numbers and special characters (excluding “'”, “””, “;”, “.””, “&”). The password shall contain at least two categories. Usually we recommend the strong password.
STRONG PASSWORD RECOMMENDED-For your device own safety, please create a strong password of your own choosing. We also recommend you change your password periodically especially in the high security system.
- For the user of the account right, it can change the password of other user.

Group

Click Group button, the interface is shown as below. Here you can add/delete group, or change group password and etc. See Figure 3-79.



Figure 3-79

Add Group

Click add group button, the interface is shown as below. See Figure 3-80. Here you can input group name and then input some memo information if necessary.

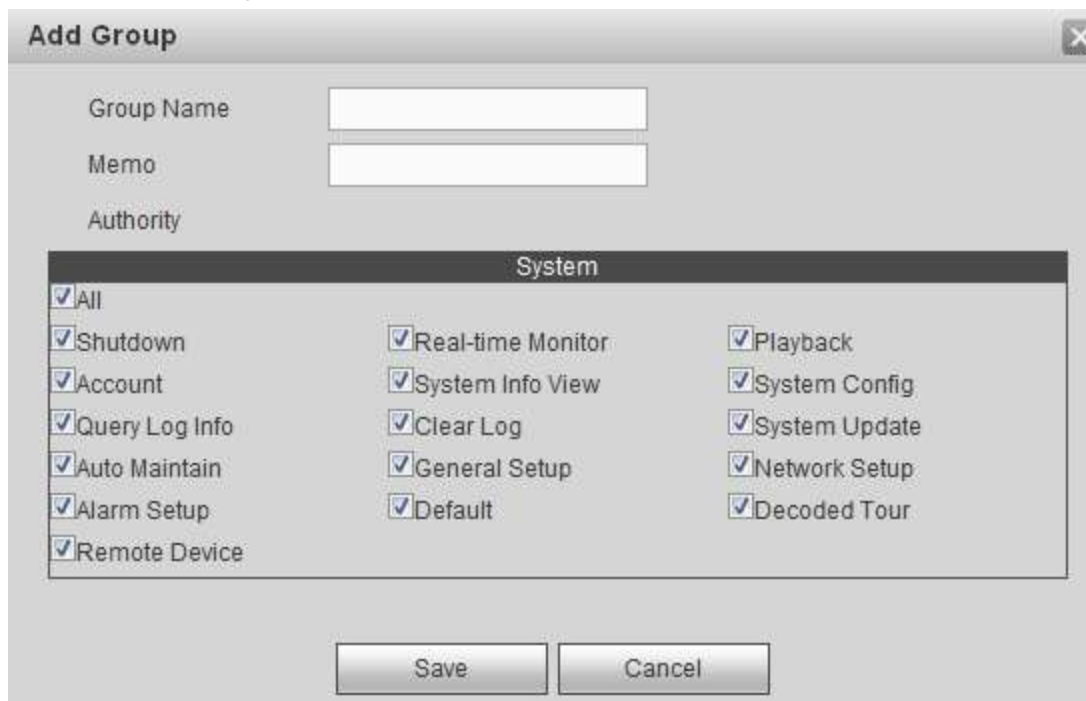

Figure 3-80

Modify Group

In Figure 3-79, click Modify button, you can see the following interface. Here you change group memory information, authorities and etc. See Figure 3-81.

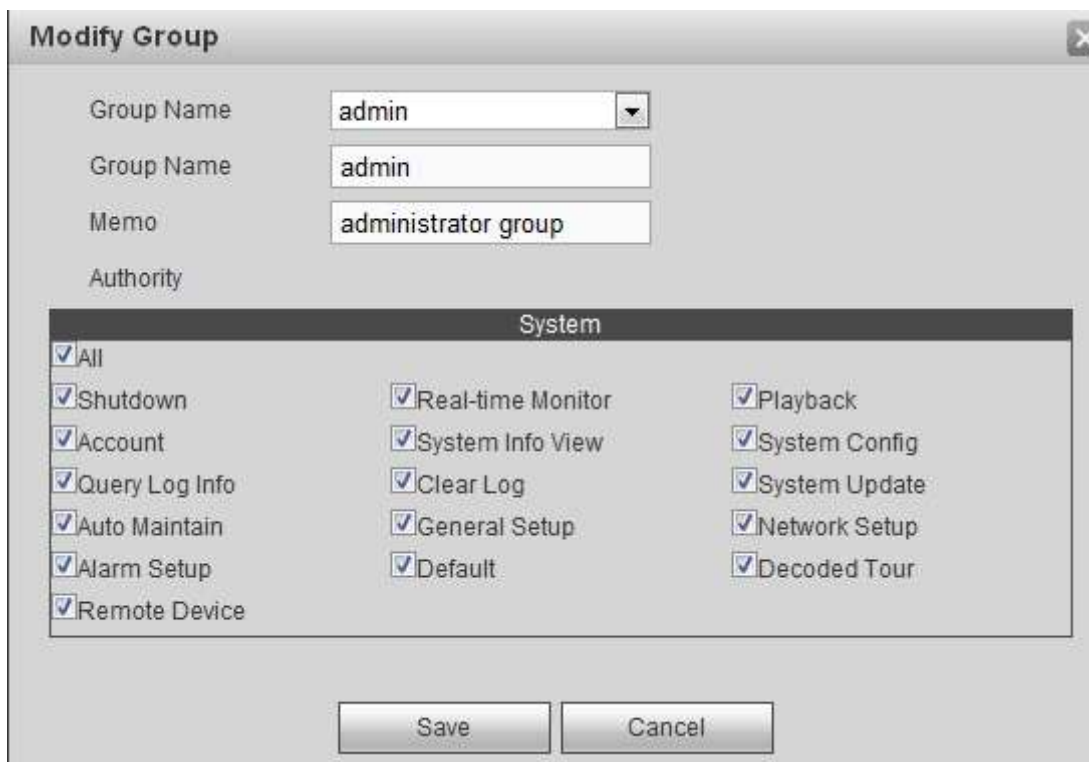

Figure 3-81

Delete group

In Figure 3-79, click  to delete a group.

3.12.9 IP Filter

To enhance device network security and protect device data, please set the access right of the IP host (IP host here refers to the PC IP or the server).

- Trusted sites: After you enabled trusted sites function, only the IP listed below can access current device.
- Blocked sites: If you enable blocked sites function, the following listed IP addresses cannot access current device.



Note

- The trusted site and the blocked site function cannot be valid at the same time.
- This function is for 9-channel 4K high definition series/9-channel 4K high definition (with 4 input ports) series/12-channel 4K high definition series/12-channel 4K high definition (with 4 input ports) series/15-channel 4K high definition series/15-channel 4K high definition (with 4 input ports) series/18-channel 4K high definition series/18-channel 4K high definition (with 4 input ports) series/21-channel 4K high definition series/21-channel 4K high definition (with 4 input ports) series.

Step 1 From Setting->IP Filter.

Enter IP filter interface. See Figure 3-82.



Figure 3-82

Step 2 Check the Enable box.
Device displays trusted sites/block sites.

Step 3 Add trusted sites or block sites.
1. Select trusted site or blocked site.
2. Click Add.
Enter Add interface. See Figure 3-83.

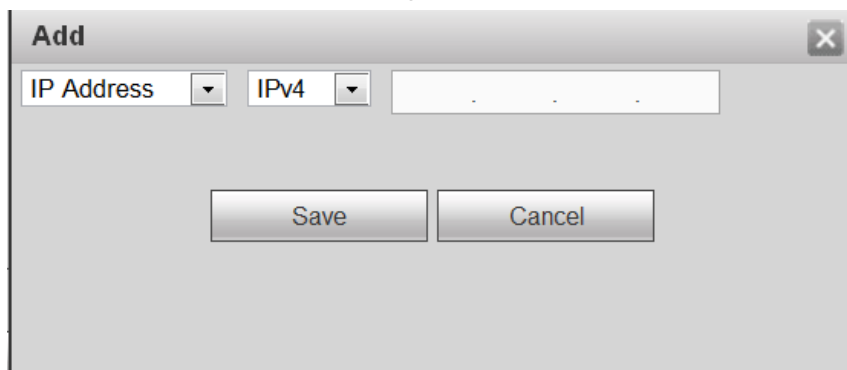

Figure 3-83

3. Set IP address.

Name	Function
IP address	<p>Click the dropdown box and then select add mode.</p> <ul style="list-style-type: none"> ● IP address: Input the IP address you want to add to block sites or trusted sited. ● IP Segment: Input the IP segment you want to add to block sites or trusted sited. You can add several IP hosts at the same time.
IPv4	<p>Click the dropdown box to select IP address protocol.</p> <ul style="list-style-type: none"> ● IPv4: IP address adopts IPv4 mode such as 192.168.5.10. ● IPv6: IP address adopts IPv6 mode such as aa:aa:aa:aa:aa:aa:aa:aa.

4. Click OK
Device goes back to IP filter interface.

Step 4 Click Save button.

- If you enabled trusted sites, only the IP address in the trusted sites list can access the device.
- If you enabled blocked sites, the IP address in the blocked sites cannot access the device. Devices prompts the current device is in the blacklist and cannot login.

3.12.10 Remote Device

Here you can manually add or auto add remote device, and change remote device information or delete it.

From Setting->Remote device, you can go to the following interface. See Figure 3-84.

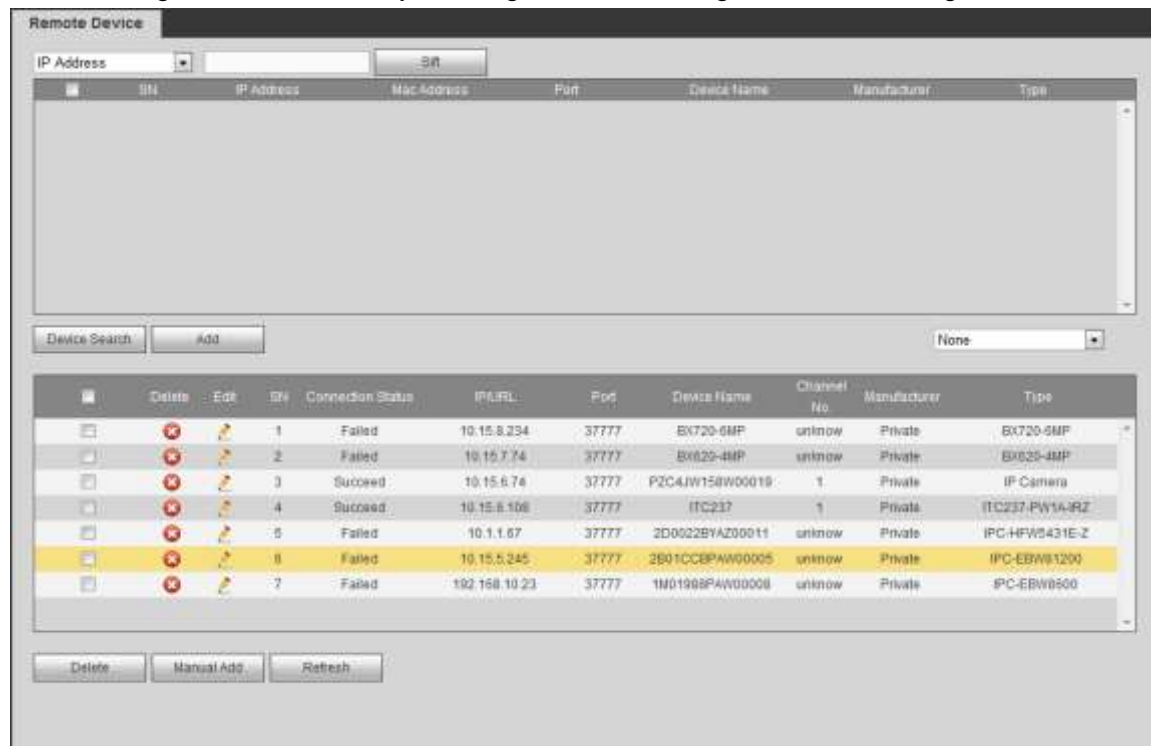

Figure 3-84

Search remote device

Click Device search button, you can view the searched IP addresses at the top pane of the interface.



Note

- You can use IP address or MAC address to search device. System supports fuzzy search.
- For the device in the added device list, you cannot see it at the top pane of the interface.

Double click an IP address or check one or more IP addresses at the same time and then click Add button, you can add current device to the added devices at the bottom pane of the interface. System supports batch add function.

Add remote device

Click Manual Add button, you can add a device directly. See Figure 3-85.

- Manufacturer: Select the manufacture from the dropdown list. It includes: Private/ONVIF/General/Hikvision and etc.

Note

Hikvision protocol is for some series such as 1-channel 4K high definition series/1-channel 4K(H.265) high definition series/9-channel 4K high definition series/9-channel 4K high definition (with 4 input ports) series/9-channel high definition series/16-channel high definition series/12-channel 4K high definition series/12-channel 4K high definition (with 4 input ports) series/15-channel 4K high definition series/15-channel 4K high definition (with 4 input ports) series/18-channel 4K high definition series/18-channel 4K high definition (with 4 input ports) series/21-channel 4K high definition series/21-channel 4K high definition (with 4 input ports) series.

- Connection mode: It includes: TCP/AUTO/UDP. This item is only valid when the manufacturer is general.
- Device name: Input remote device name here.
- IP address: Input remote device IP address.
- Port: Input TCP port value. The default setup is 37777.
- Channel No.: It is to display channel total amount of the remote device.
- User name: Input the user name you login the remote device.
- Password: Input the password you login the remote device.
- Remote channel amount: The channel mount of the remote device.
- RTSP port: Input the RTSP port of the remote device. The default setup is 554. **Please note this setup is for ONVIF/Hikvision connection mode. Please make sure the setup here is the same as the ONVIF/Hikvision port of the remote device.**
- HTTP port: Input the HTTP port of the remote device. The default setup is 80. **Please note this setup is for ONVIF/Hikvision connection mode. Please make sure the setup here is the same as the ONVIF/Hikvision port of the remote device.**
- URL: Input remote device URL. **Please note this setup is for General connection mode.**

The image shows a 'Manual Add' dialog box with the following fields and values:

Manufacturer	Private
Connection Mode	TCP
Device Name	
IP	
Port	37777
Channel No.	1
User Name	
Password	



Buttons: Save, Cancel

Figure 3-85

Note

You cannot add current remote device if its IP or the TCP port is the same as the device in the added device list.

Change or delete remote device

- Change remote device: In Figure 3-84, click , you can see an interface similar to Figure 3-85. You can change the remote device information and then click Save button.
- Delete remote device: On the added device list, click , you can delete a remote device. You can select several devices at the same time and then click  to delete.

Note

This function is to delete the idle device. That is to say, you cannot delete a device when there is still decoding channel.

3.12.11 Fan Control

Note

This function is for 12-channel 4K high definition series/12-channel 4K high definition (with

4 input ports) series/15-channel 4K high definition series/15-channel 4K high definition (with 4 input ports) series/18-channel 4K high definition series/18-channel 4K high definition (with 4 input ports) series/21-channel 4K high definition series/21-channel 4K high definition (with 4 input ports) series.

The fan speed includes low-speed, medium-speed, high-speed. Different temperature range can trigger different fan speed.

From Setting->Fan control, you can go to the following interface. See Figure 3-86.

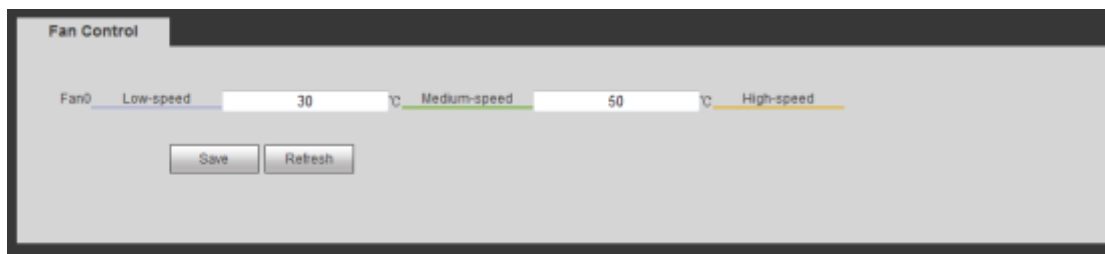

Figure 3-86

3.13 Maintain

3.13.1 Version

From Maintain->Version, here you can view device hardware feature and software version information. See Figure 3-87.

Note

Please note the following figure for reference only.

Version	
Alarm In:	4
Alarm Out:	4
SN:	000000000000000000
Web:	3.2.0.0
System Version:	3.200.2.0
Build Date:	2016-04-22

Figure 3-87

3.13.2 Log

It is to view system log.

Step 1 From Maintain->log, enter log interface. See Figure 3-88.

Step 2 Set parameters.

- Type: Log types include: system operation, configuration operation, alarm event, user management, log clear.

- Search: You can select log type from the drop down list and then click search button to view the list.
- Clear: You can click this button to delete all displayed log files.
- Backup: You can click this button to backup log files to current PC.

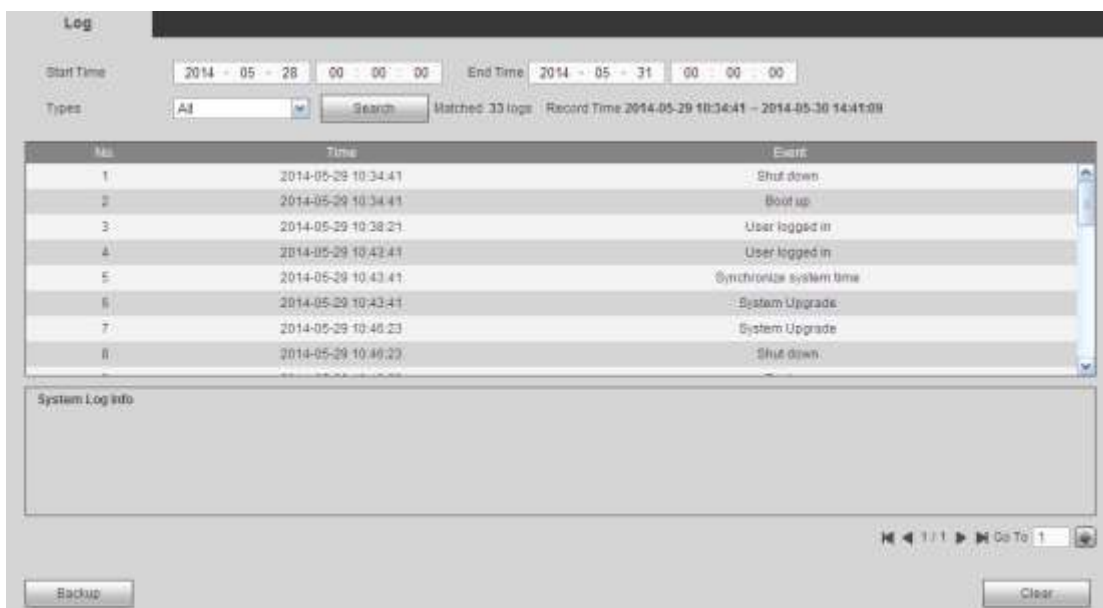

Figure 3-88

Click backup button, the interface is shown as in Figure 3-89.



Figure 3-89

3.13.3 Security

SSH is to open the background debug port for the engineer. It becomes activated after reboot the system. It is disabled by default.

Note

This function is for 9-channel 4K high definition series/9-channel 4K high definition (with 4 input ports) series product only.

Step 1 From Maintain->Security, enter SSH interface. See Figure 3-90.

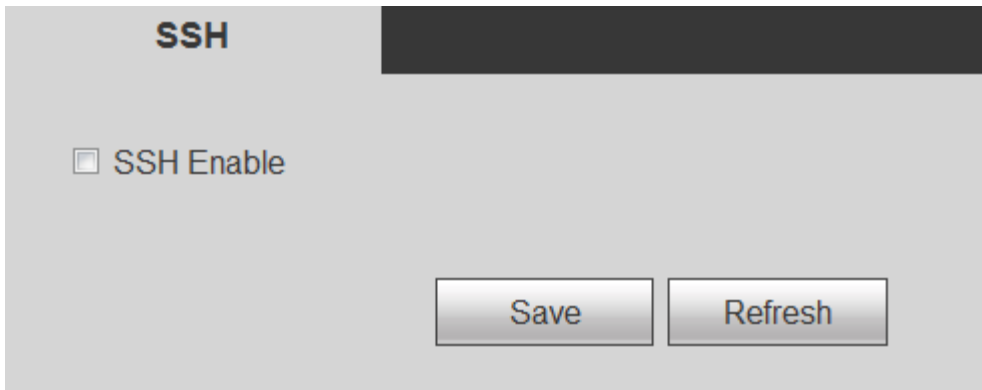

Figure 3-90



Step 2 Check the box to enable SSH function and then click the Save button.

3.13.4 Card Info

 **Note**

This function is for 12-channel 4K high definition/12-channel 4K high definition (with 4 input ports) series/15-channel 4K high definition series/15-channel 4K high definition (with 4 input ports) series/18-channel 4K high definition series/18-channel 4K high definition (with 4 input ports) series/21-channel 4K high definition series/21-channel 4K high definition (with 4 input ports) series.

From Maintain->Card Info, here you can card information. See Figure 3-91.

-  : Current slot has card.
-  : Current slot does not have card.

Status	Slot	Type	Type	Status	Temperature	Version
	Slot1	Decoding Card	HD98	Normal	43°C	3.200.0000.0.Oct 9 2016 11:22:35
	Slot2					
	Slot3	Decoding Card	HD98	Normal	46°C	3.200.0000.0.Oct 9 2016 11:22:35
	Slot4					
	Slot5	Decoding Card	HD98	Normal	48°C	3.200.0000.0.Oct 9 2016 11:22:35
	Main Card	Main Card		Normal	33°C	3.200.0000.0

Figure 3-91

3.13.5 System Info

 **Note**

This function is for 12-channel 4K high definition/12-channel 4K high definition (with 4 input ports) series/15-channel 4K high definition series/15-channel 4K high definition (with 4 input ports) series/18-channel 4K high definition series/18-channel 4K high definition (with 4 input ports) series/21-channel 4K high definition series/21-channel 4K high

definition (with 4 input ports) series.

From Maintain->System status, here you can network status, CPU status, fan status, power status, memory status and etc. See Figure 3-92.

- Network status: It is to display network card connection status, data sent and received information.
- CPU status: The CPU status of all cards.
- Fan status: The fan running status.
- Power status: The on/off status of the two power source.
- Memory status: The memory usage information.



Figure 3-92

3.13.6 Sniffer

From Maintain->Sniffer, you can go to Sniffer interface. In this interface you can save Sniffer data to a flash drive.

Please follow the steps listed below.

- Step 1 Insert flash drive to the USB port at the front panel of the decoder and then click refresh button. After you see device name, space, you can see system has detected flash drive. Now you can go to the next step. See Figure 3-93 or Figure 3-94.

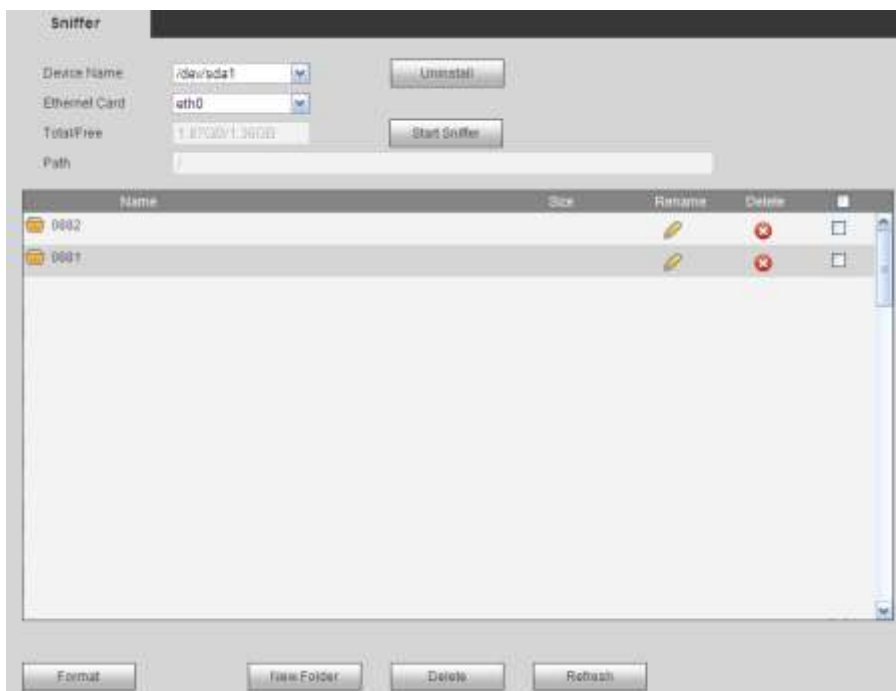

Figure 3-93

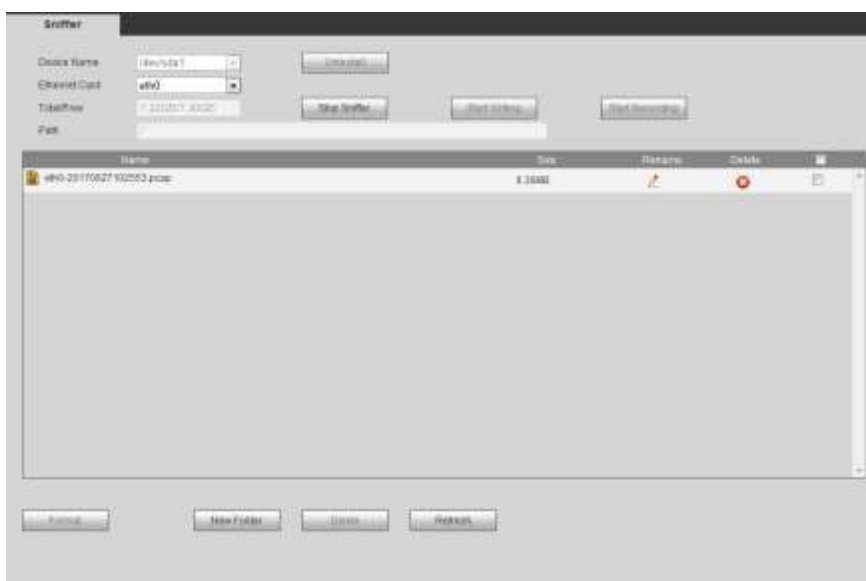

Figure 3-94

Step 2 In Figure 3-93, click **Start Sniffer** button, you can see system writes data to the flash drive and the **Start Sniffer** button becomes **Stop Sniffer** button. See Figure 3-95.

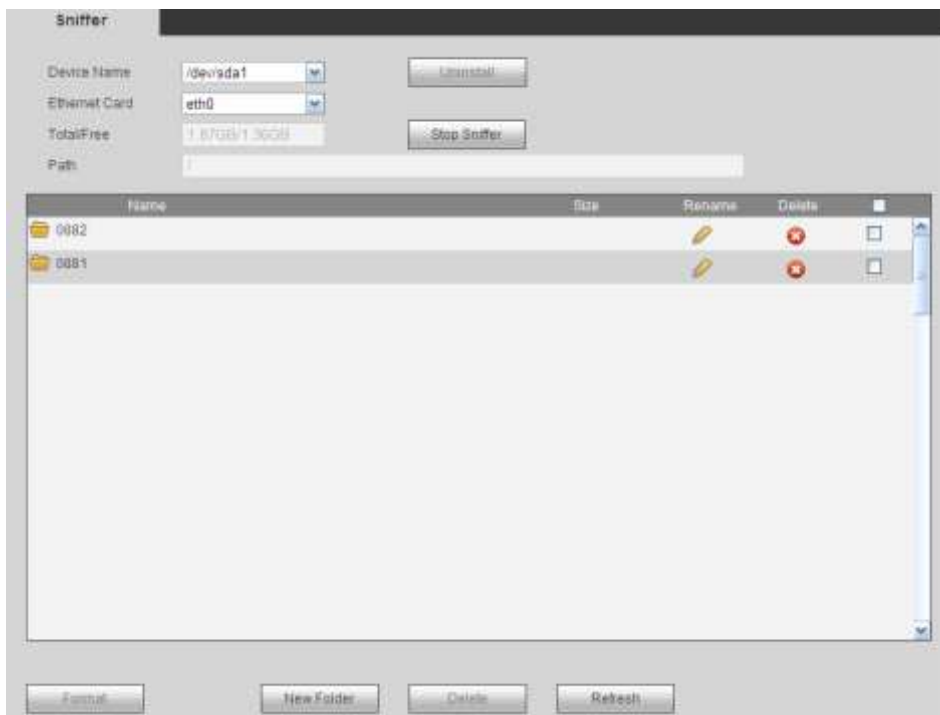

Figure 3-95

Step 3 Click **Stop Sniffer** button, system stops writing data to the flash drive. Click refresh button, you can see a file with extension name. pcap. See Figure 3-96 or Figure 3-97.

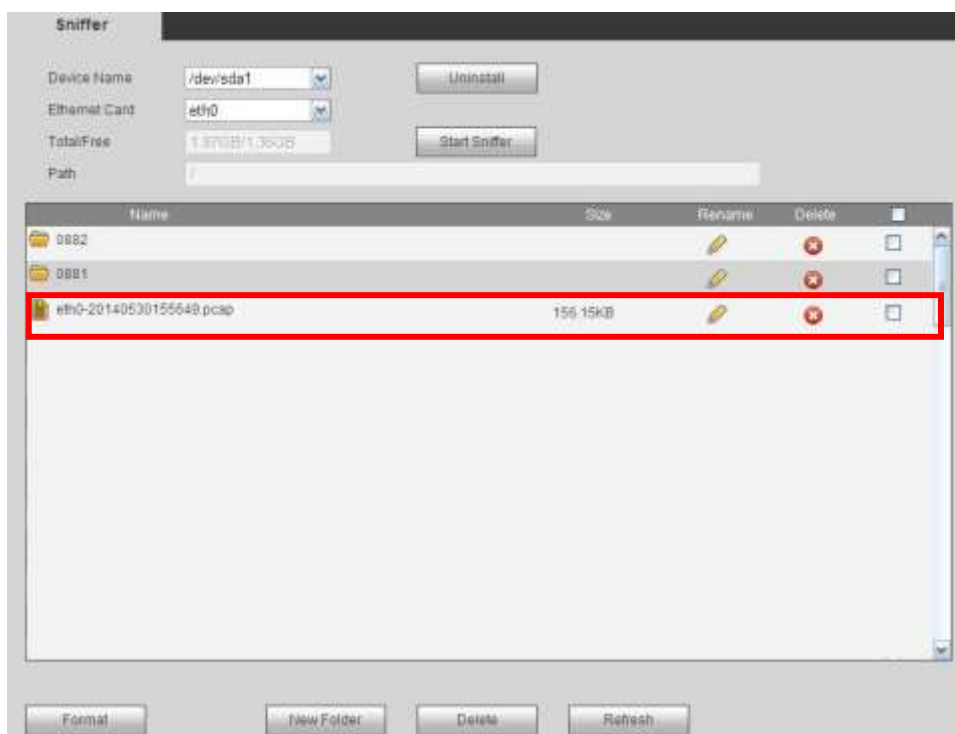

Figure 3-96

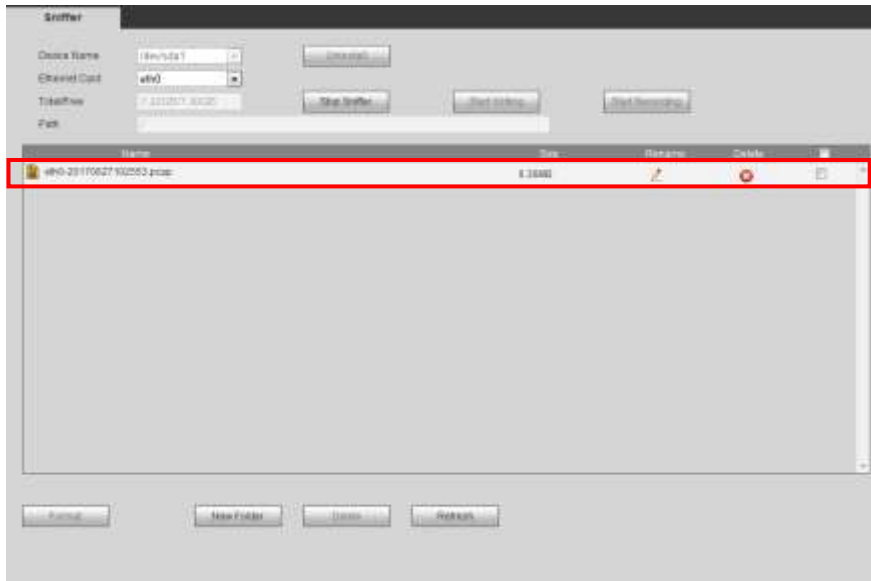

Figure 3-97

Step 4 Click **Uninstall** button and remove the flash drive. See Figure 3-98.

 **Note**

Before you remove flash drive, please click Uninstall button first.



Figure 3-98

- Begin Sniffer: Click it, system begins sniffer and write data to the specified directory of the flash drive.
- Stop Sniffer: Click it, system stops writing data to the flash drive.
- Uninstall: Click it and then remove the flash drive from the device.

 **Note**



Before you remove flash drive, please click Uninstall button.

- Click Format, it is to format the connected flash disk.
- Click Refresh to refresh flash disk sniffer interface.
- Select a file on the flash disk and then click Delete, it is to delete the file.
- Click New folder to create a new folder and give it a name.
- Click Start writing, system can save COM logs on the flash disk.

- Click Start recording and select the corresponding channel, it can write bit streams of current channel to the flash disk.

Note

Only 1-channel 4K(H.265) high definition series /4-channel 4K high definition series/9-channel 4K high definition series/9-channel 4K high definition (with 4 input ports) series supports writing log and writing record function.

- Click  to rename the file name on the flash disk.
- Click  to delete the file name on the flash disk.

3.13.7 Default and Backup

Note

- For 9-channel high definition series/ /16-channel high definition series/1-channel 4K high definition series, please refer to Figure 3-99. Please note 16-channel high definition series does not support alarm default setup function.
- For 1-channel 4K (H.265) high definition series /4-channel 4K high definition series 9-channel high definition series/ 9-channel 4K high definition series/ 9-channel 4K high definition (with 4 input ports) series/12-channel 4K high definition series/12-channel 4K high definition (with 4 input ports) series/15-channel 4K high definition series/15-channel 4K high definition (with 4 input ports) series/18-channel 4K high definition series/18-channel 4K high definition (with 4 input ports) series/21-channel 4K high definition series/21-channel 4K high definition (with 4 input ports) series, please refer to Figure 3-100.

From maintain->Default and backup, the default and backup interface is shown as below.

- Select all: Check the box here to select general/RS232/Network/Alarm /decode tour/splicing wall/connection mode to restore factory default setup.
- Default: Restore factory default setup.
- Export: Export system configuration to local PC.
- Import: Import configuration from PC to the system.
- Import monitor parameters: Click to import monitor parameters.
- Export monitor parameters: Click to export monitor parameters.

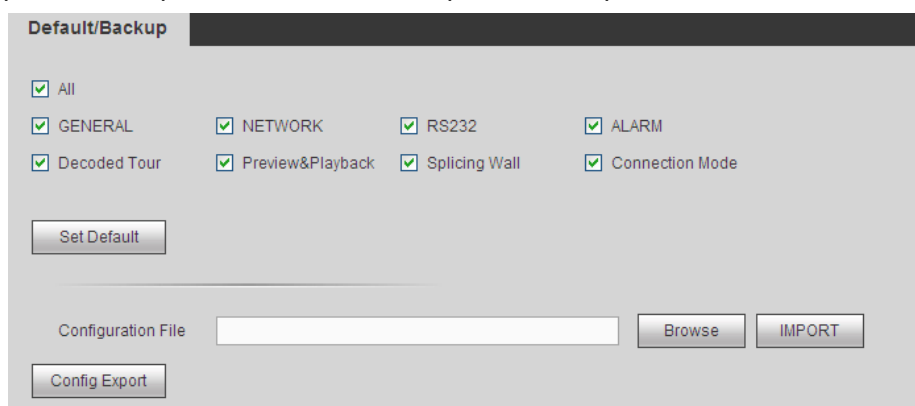

Figure 3-99

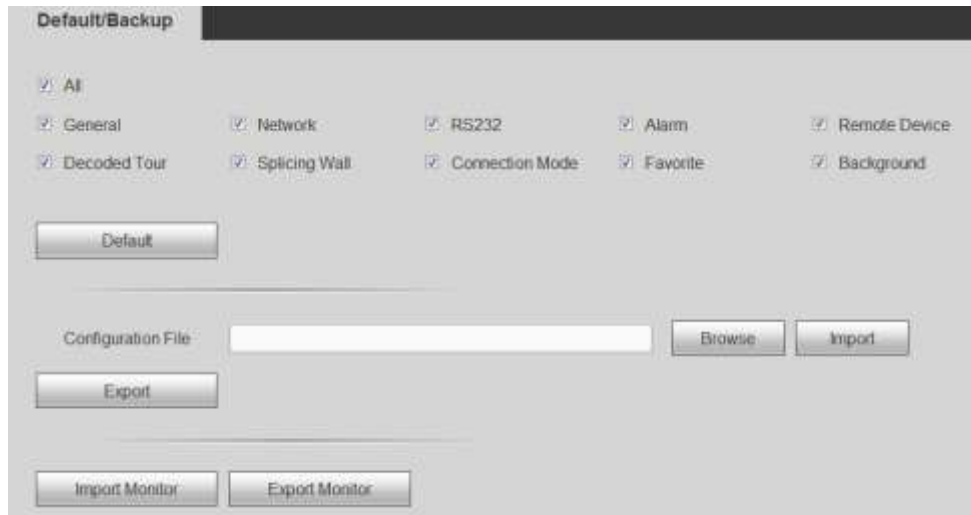

Figure 3-100

3.13.8 Auto Maintenance

From Maintain->auto maintenance, here you can select auto reboot and auto delete old files interval from the dropdown list. See Figure 3-101.

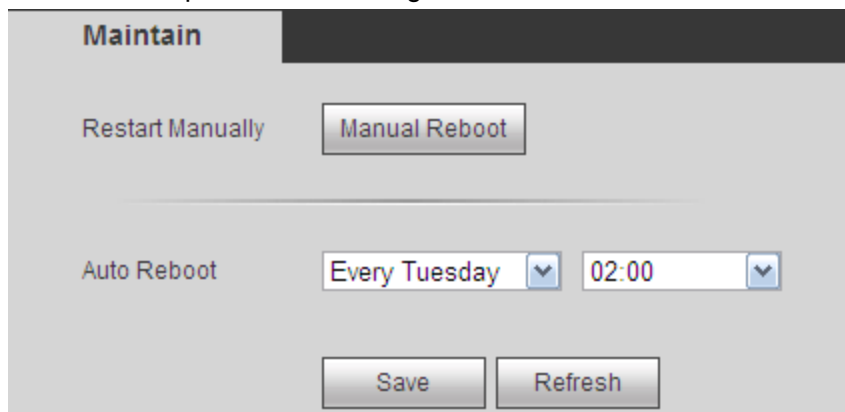

Figure 3-101

3.13.9 Connection mode

Note

Do not change the connection mode manually! After the decoder is added to the DSS2.2, it can auto switch to the transfer mode.

From Maintain->Connection mode, the connection mode interface is shown as below. See Figure 3-102.

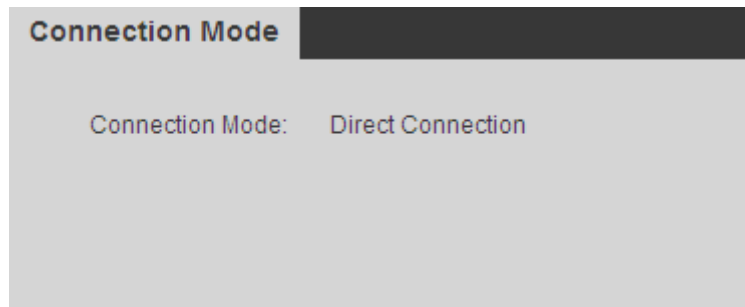

Figure 3-102

3.14 Log out

Click log out button, you can go back to login interface. See Figure 3-103.



Figure 3-103

4 Local GUI Operation

This chapter is for 1/4-channel 4K high definition series/ 1-channel 4K (H.265) high definition series product only.

4.1 Boot up



Caution

Before the boot up, please make sure:

- For device security, please connect the device to the power adapter first and then connect the device to the power socket.
- The rated input voltage matches the device power on-off button. Please make sure the power wire connection is OK. Then click the power on-off button.
- Always use the stable current, if necessary UPS is a best alternative measure.

Please follow the steps listed below to boot up the device.

- Connect the device to the monitor and then connect a mouse.
- Connect power cable.
- Click the power button at the front or rear panel and then boot up the device. After device booted up, the system is in multiple-channel display mode by default.

4.2 About Interface

The main interface is shown as below. See Figure 4-1 (1-channel 4K high definition series product/ 1-channel 4K (H.265) high definition series) and Figure 4-2 (4-channel 4K high definition series product).

The local GUI interface consists of the three parts.

Please refer to the following sheet for detailed information.

SN	Name	Function
1	Main Interface	Right click mouse, you can see it includes the four items: MAIN MENU, REMOTE DEVICE, NETWORK, CLOSE.
2	Device Tree	It is to list current added device(s) and channel(s).
3	Shortcut Menu	It includes the 1/4/9/16 split mode, screen selection button and MAIN MENU shortcut button.  Note Only 4-channel 4K high definition series products supports screen selection button function.

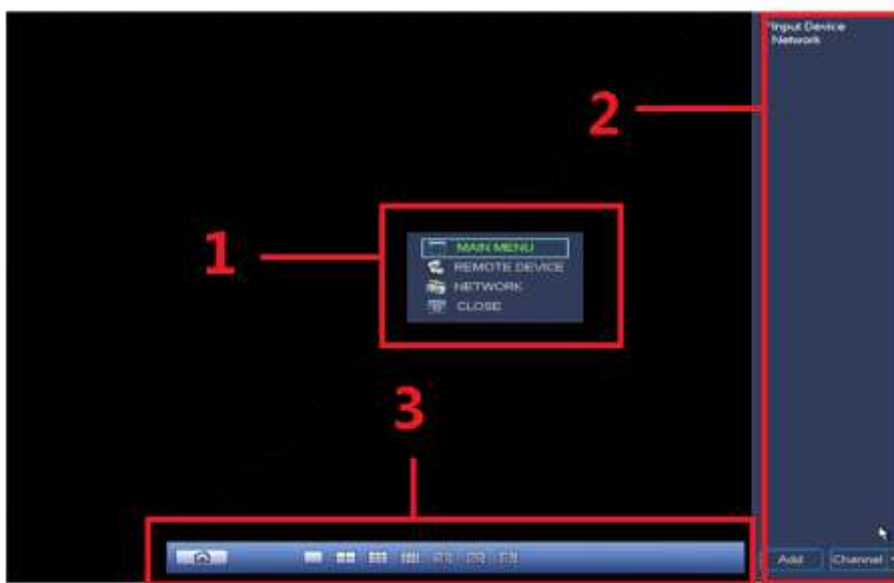

Figure 4-1

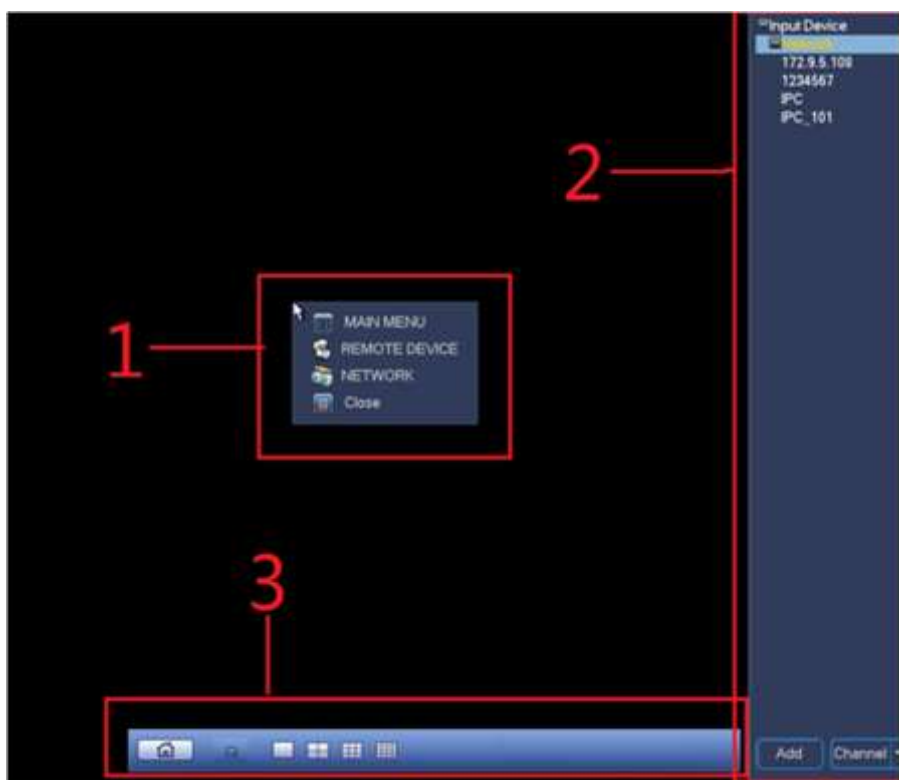

Figure 4-2

4.2.1 Main Interface

Right click mouse, you can see the menu includes four items: MAIN MENU (chapter 4.2.1), REMOTE DEVICE (chapter 4.3.1.3), NETWORK (chapter 4.3.1.2), CLOSE (chapter 4.3.4).

4.2.2 Device Tree

The device tree adopts the list to display current device and channel. The device tree function is disabled by default. Move your mouse to the right side margin of the screen, system can auto display the device tree. Right click the device tree to hide it.

4.2.2.1 Display Mode

At the right bottom corner, you can see there are two display modes: Device Display/Channel Display.

Select Device Display, you can see the following interface. See Figure 4-3.

Now you can see device name (pane 1) and the channels (pane 2).

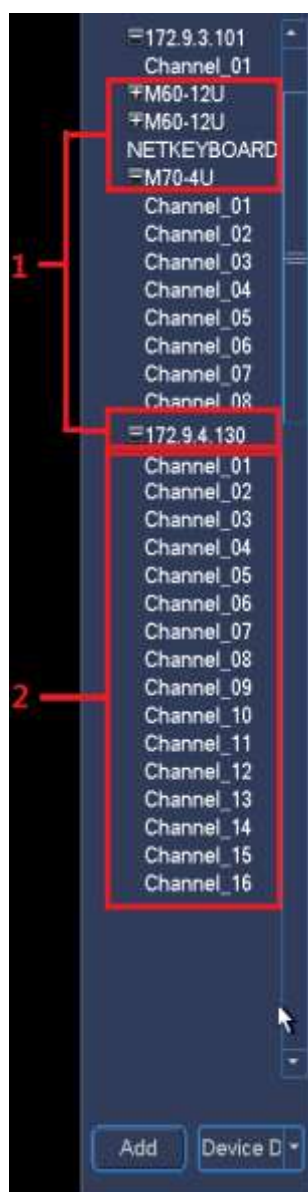

Figure 4-3

Select Channel Display, the device tree is shown as in Figure 4-4. In this mode, system does not display device, it only displays all channels.

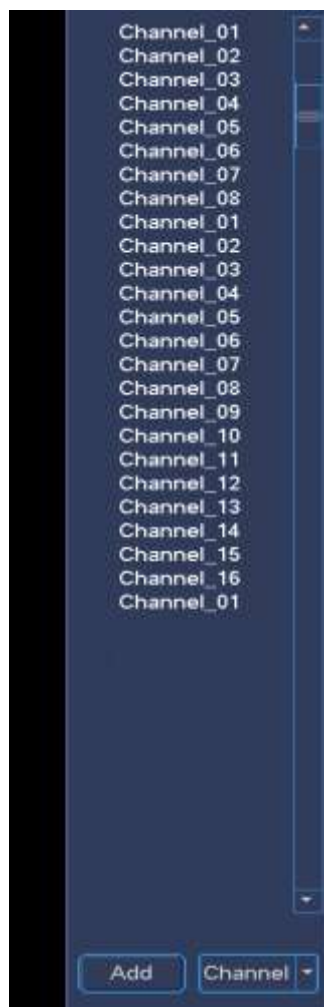

Figure 4-4

Note

Left click mouse and drag the signal to the corresponding window. It is to output the signal to the specified window.

4.2.2.2 Shortcut Menu to Add Device

Click Add button, system pops up Remote Device interface. Please refer to chapter 4.3.1.3 for detailed information.

4.2.2.3 Output Current Channel to the TV Wall

There are two ways for you to output current channel to the TV wall.

- Drag the channel from the device tree to the corresponding window and then release.
- Select display window and then double click the channel.

4.2.3 Shortcut Menu

The shortcut menu consists of two items. It is hiding by default. Move your mouse to the bottom of the display window, you can see it. Right click the shortcut menu, system auto hides it. See Figure 4-5 (1-channel 4K high definition series/1-channel 4K(H.265) high definition series) and Figure 2-17(4-channel 4K high definition series).

- Pane 1: Click the button; you can go to the main menu.
- Pane 2: It is to display window split mode. It includes 1/4/9/16-window.
- Pane 3: Click to output signal to the specified screen.



Figure 4-5



Figure 4-6

Step 1 Click  to select the corresponding screen. See Figure 4-7.



Figure 4-7

 **Note**

This function is for 4-channel 4K high definition series only.

Step 2 Output signal to the TV wall. See Figure 4-8.

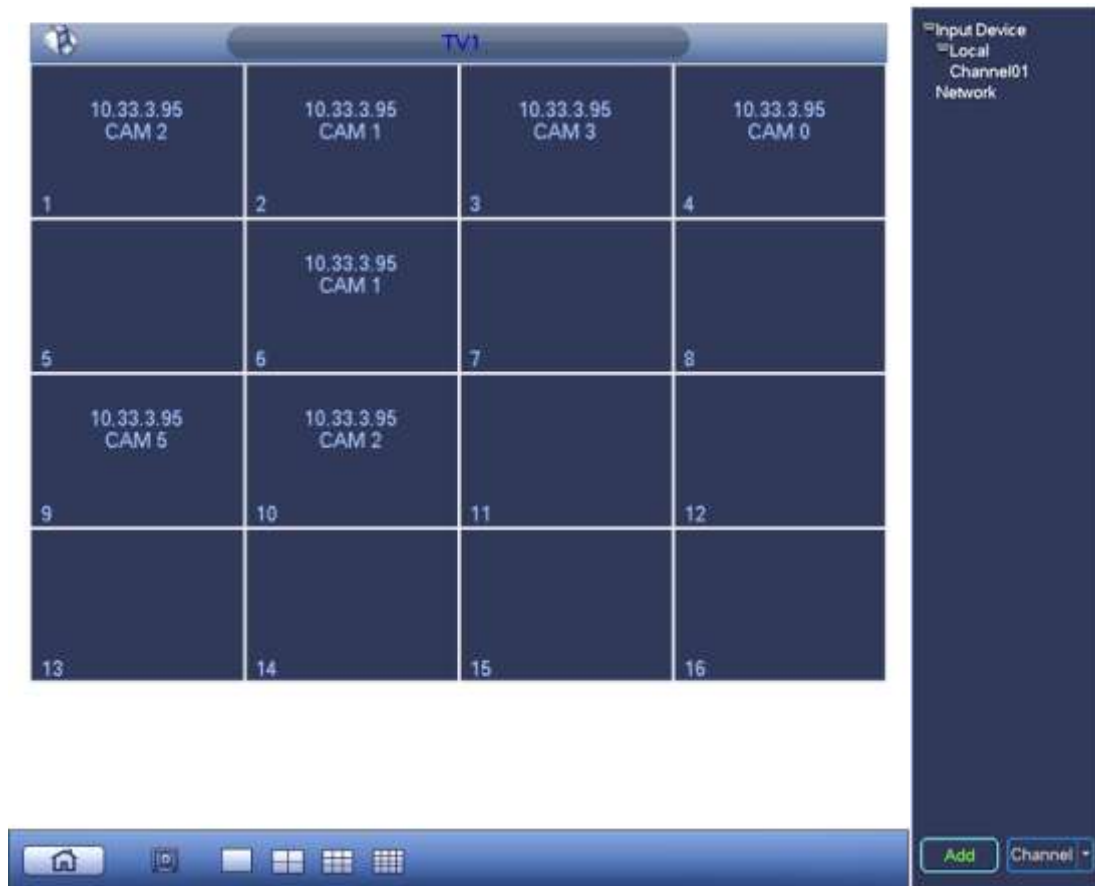

Figure 4-8

4.3 GUI Basic Operation

4.3.1 Main Menu

In Figure 4-1, click the button 1 to go to the following interface. See Figure 4-9. It includes seven items: General/network/remote device/decode info/sniffer/version/shutdown.



Figure 4-9

Step 1 For General/network/remote device interface, you need to input corresponding user name and password to enter. See Figure 4-10.



Figure 4-10

Step 2 System default user name is **admin** and password is **admin**. Click OK, system pops up the following dialogue box. See Figure 4-11.



Figure 4-11

Step 3 Input new password and then confirm, click OK button.

System pops up dialogue box, the password has successfully changed. System enter the corresponding menu.



Note

The password ranges from 8 to 32 digitals. It can contain letters, numbers and special characters (excluding “ ”, “ ”, “;”, “:”, “&”). The password shall contain at least two categories. Usually we recommend the strong password.



WARNING

STRONG PASSWORD RECOMMENDED-For your device own safety, please create a strong password of your own choosing. We also recommend you change your password periodically especially in the high security system.

4.3.1.1 General

General setting includes the following items. See Figure 4-12(1-channel 4K high definition series/1-channel 4K (H.265) high definition series) and Figure 4-13(1-channel 4K high definition series).

- System time: It is to change current system time and date. Please click Save button after the modification.
- Date format: There are three types: YYYYY-MM-DD: MM-DD-YYYYY or DD-MM-YYYY.
- Date separator: There are three denotations to separate date: dot, beeline and solidus.
- Time format: It is to set time format: 24H/12H.
- Resolution: It is to set output resolution. The default setup is 1280*1024. **Please note system needs to reboot to activate current setup.**
- Output type: It is to set output type. It includes: VGA/HDMI.



Note

This function is not for 4-channel 4K high definition series product.

- Device ID: Input a corresponding device name here.
- Device No: Here you can set device number.
- DST: Here you can set DST time and date. Here you can set start time and end time by setting corresponding week setup or by setting corresponding date setup. See Figure 4-14 and Figure 4-15.

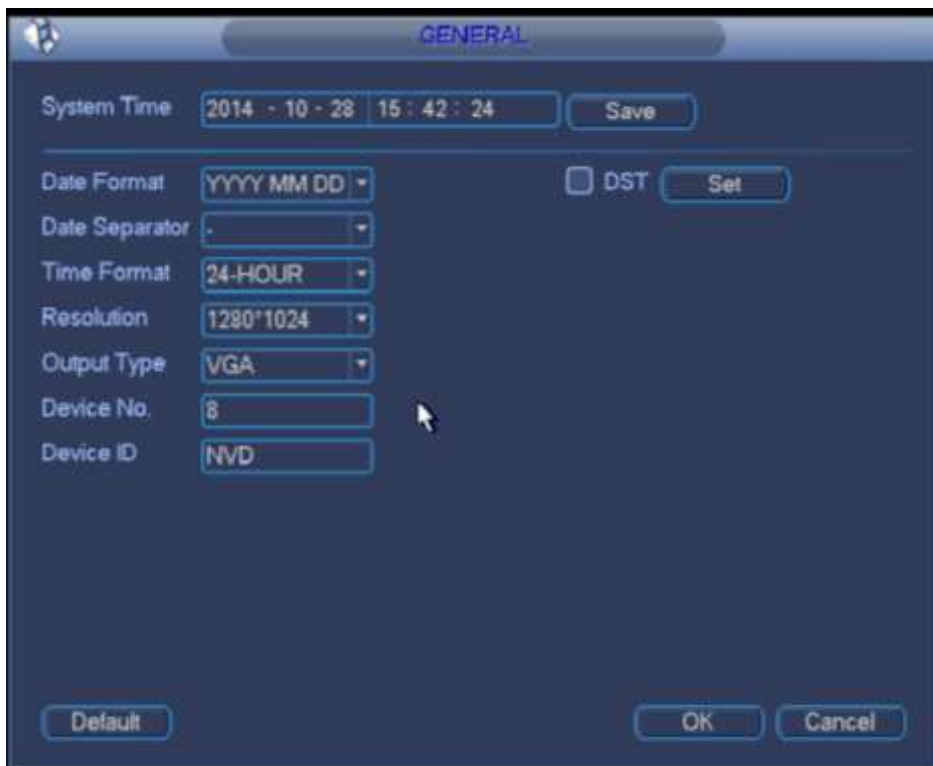

Figure 4-12

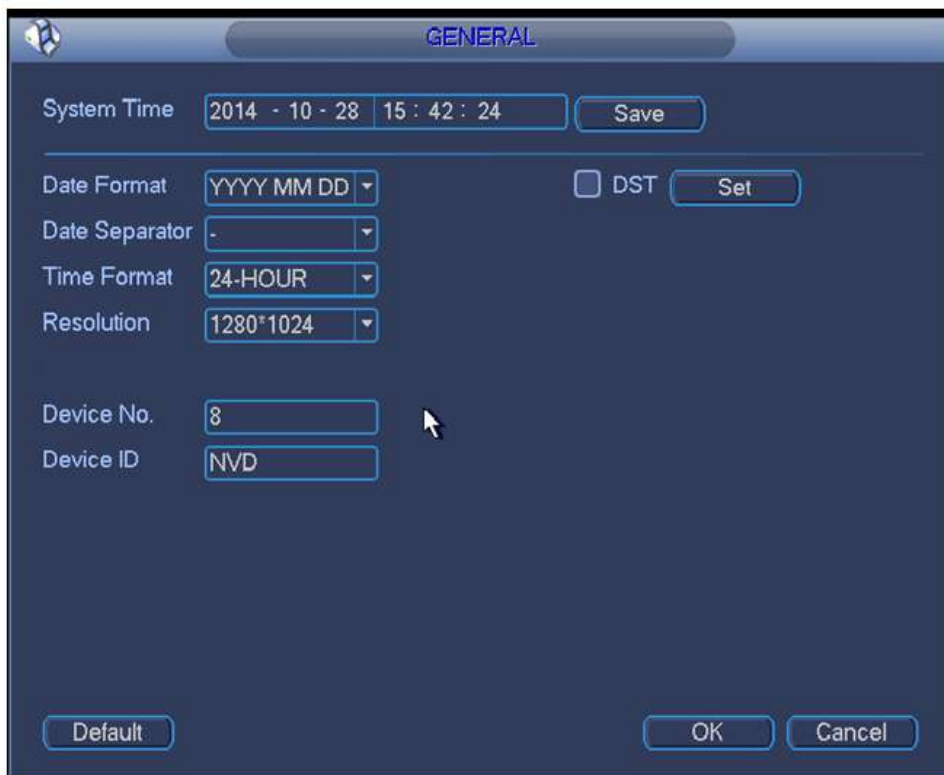

Figure 4-13



Figure 4-14



Figure 4-15

4.3.1.2 Network

The network interface is shown as in Figure 4-16.

- IP Version: There are two options: IPv4 and IPv6. Right now, system supports these two IP address format and you can access via them.
- MAC address: The host in the LAN can get a unique MAC address. It is for you to access in the LAN. It is read-only.
- IP address: Here you can use up/down button (▲▼) or input the corresponding number to input IP address. Then you can set the corresponding subnet mask the default gateway.
- Gateway: Here you can input the default gateway. Please note system needs to check the validity of all IPv6 addresses. The IP address and the default gateway shall be in the same IP section. That is to say, the specified length of the subnet prefix shall have the same string.
- DHCP: It is to auto search IP. When enable DHCP function, you cannot modify IP/Subnet mask /Gateway. These values are from DHCP function. If you have not enabled DHCP function, IP/Subnet mask/Gateway display as zero. You need to disable DHCP function to view current IP information. Besides, when PPPoE is operating, you cannot modify IP/Subnet mask /Gateway.
- TCP port: It is to set TCP port. Default value is 37777.
- UDP port: It is to set UDP port. Default value is 37778.
- HTTP port: It is to set HTTP port.
- HTTPS port: It is to set HTTPS port.

- Preferred DNS server: DNS server IP address.
- Alternate DNS server: DNS server alternate address.
- Default: It is to restore factory default setup.

The screenshot shows a 'NETWORK' configuration window with the following fields and values:

IP Version	IPv4	
Mac Address	14:08:21:14:22:03	
IP Address	172 . 9 . 5 . 101	<input type="checkbox"/> DHCP
Subnet Mask	255 . 255 . 0 . 0	
Gateway	172 . 9 . 0 . 1	
TCP Port	37777	HTTP Port: 80
UDP Port	37778	HTTPS Port: 443
Preferred DNS	8 . 8 . 8 . 8	
Alternate DNS Server	8 . 8 . 4 . 4	

At the bottom of the window, there are three buttons: 'Default', 'Save', and 'Cancel'.

Figure 4-16

4.3.1.3 Remote Device

You can add network camera here. See Figure 4-17(1-channel 4K high definition series) or Figure 4-18 (1-channel 4K(H.265) high definition series/4-channel 4K high definition series) .

- IP search: It is to search the network devices in current IP segment.
- Add: It is to add selected device(s) to the list.
- Delete: It is to delete selected device(s).
- Manual add: It is to add one device manually.



Figure 4-17



Figure 4-18

Add by IP Search

Step 1 In Figure 4-17, Click IP search button, you can view all network devices in current IP segment. You can view device IP address, port, device name, manufacturer and type.

Step 2 Check corresponding box to select the network device you want to add. You can select several devices one by one. Check the box at the top of the list, so that you can add all searched devices at the same time.

Step 3 Click Add button, you can add the device to the list.

Step 4 Click OK button.

Manual Add

Step 1 In Figure 4-17, Click Manual add button.

Step 2 System pops up the following interface. See Figure 4-19. Here you can input device name, manufacturer, IP address, TCP port, user, password.

Step 3 Click OK button.



Figure 4-19

4.3.1.4 Decoded Info

It is display channel decoded information. See Figure 4-20.

- Status: It is to display channel status. It includes monitor, playback, decode tour and idle.
- Resolution: Current bit stream resolution.
- Frame rate: Current bit stream frame rate.
- Data flow: Current bit stream connected data flow.
- Decoded flow: The decoded bit rate of current bit stream.

Channel	Status	Resolution	Frame Rate(FPS)	Data Flow(kb)
Channel1	Monitor	D1	25	1988
Channel2	Monitor	D1	25	1988
Channel3	Monitor	D1	25	1988
Channel4	Monitor	D1	25	1988
Channel5	Monitor	D1	25	1988
Channel6	Monitor	D1	25	1988
Channel7	Monitor	D1	25	1988
Channel8	Monitor	D1	25	1988
Channel9	Monitor	D1	25	1988
Channel10	Monitor	D1	25	1988
Channel11	Monitor	D1	25	0
Channel12	Monitor	D1	25	600
Channel13	Monitor	D1	25	1924
Channel14	Monitor	D1	25	1924
Channel15	Monitor	D1	25	1924
Channel16	Monitor	D1	25	1924
Channel17	Monitor	D1	25	1935
Channel18	Monitor	D1	25	1935

Figure 4-20

4.3.1.5 Sniffer

When there are some network problems such as you cannot connect to the network device, or the video is not fluent, you can sniff the network data. You can sniff via the IP, port or protocol type. The sniffer data can be saved on the local of video general platform or the USB device of the video general platform. You can use the sniffer data to quickly find the reason.

Sniffer interface is shown as below. See Figure 4-21(1-channel 4K high definition series/) or Figure 4-22(4-channel 4K high definition series/1-channel 4K(H.265) high definition series).

- Format: Click it to format current flash drive.
- Refresh: Click it to refresh flash drive Sniffer interface.
- Delete: Select a file from the flash drive and then click Delete button, you can delete it.
- New folder: It is to add a new folder and input customized folder name.



Figure 4-21

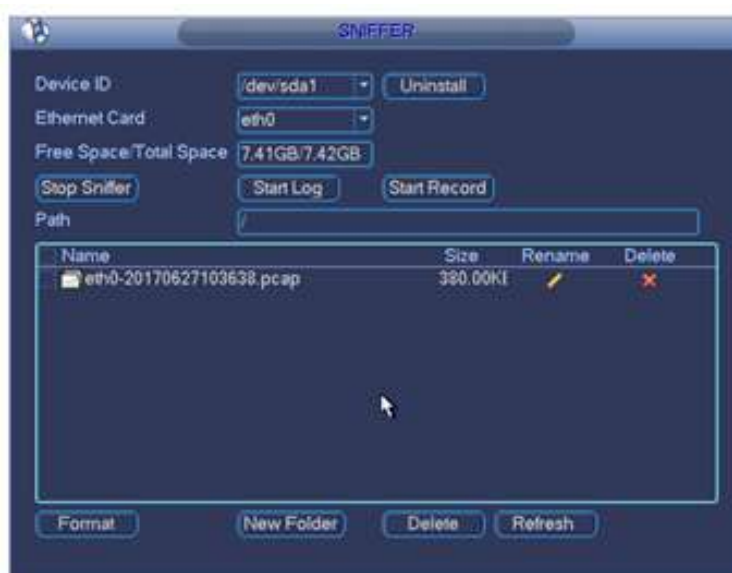

Figure 4-22

Follow the steps listed below to sniff data:

- Step 1 Insert flash drive to the USB port at the front panel of the decoder and then click refresh button. After you see device ID, free space, you can see system has detected flash drive. Now you can go to the next step. Otherwise, you need to check flash drive connection.
- Step 2 Select a folder (Click new folder button to add a new one and input customized name.). Click Start Sniffer button, you can see system writes data to the flash drive and the Start Sniffer button becomes Stop Sniffer button.
- Step 3 Click Refresh button, you can see the sniffer file .pcap.
- Step 4 Click Stop Sniffer button, system stops writing data to the flash drive.

Step 5 Click Uninstall button and remove the flash drive.

 **Note**

Before you remove flash drive, please click Uninstall button first.

- Click Format, it is to format the connected flash disk.
- Click Refresh to refresh flash disk sniffer interface.
- Select a file on the flash disk and then click Delete, it is to delete the file.
- Click New folder to create a new folder and give it a name.
- Click Start log, system can save COM logs on the flash disk.
- Click Start record and select the corresponding channel, it can write bit streams of current channel to the flash disk.

 **Note**

Only 1-channel 4K(H.265) high definition series/4-channel 4K high definition series supports Start writing log and Start writing record function.

4.3.1.6 Version

Double click Version button, you can view device current information or you can use the USB device to update the system. See Figure 4-23(1-channel 4K high definition series/1-channel 4K (H.265) high definition series) and Figure 4-24 (4-channel 4K high definition series).

You can see alarm input channel, alarm output channel, system version, built date, Web version, SN and etc.

Before you update, please copy the upgrade file to your USB device and then insert the device to the USB port. Click the Start button to begin the upgrade process.

 **Note**

4-channel 4K series product does not support upgrade function.



Figure 4-23

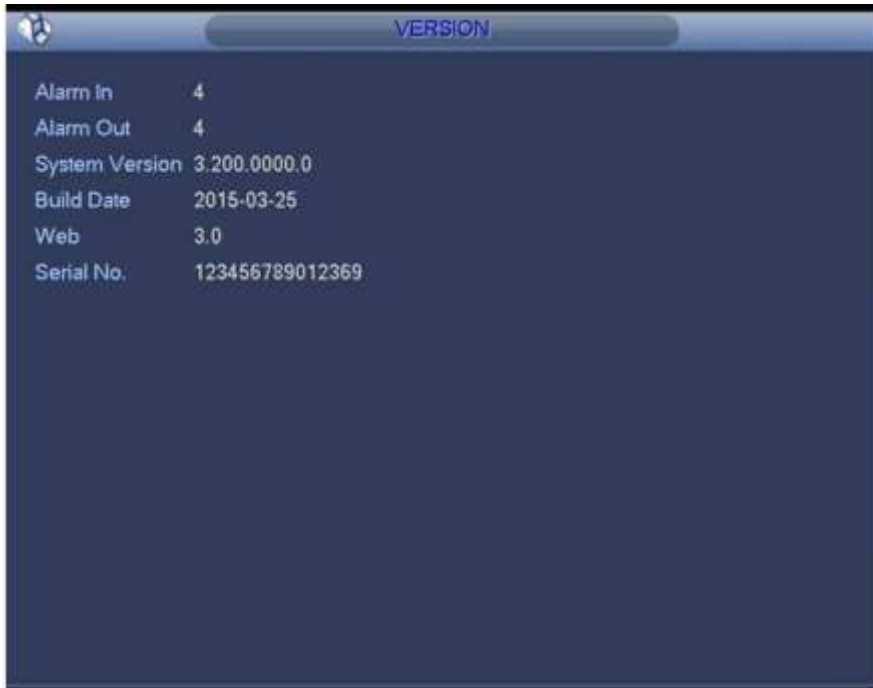

Figure 4-24

4.3.1.7 Shutdown

Double click shutdown button, system pops up a dialogue box for you to select. See Figure 4-25

- Logout menu user: log out menu. You need to input password when you login the next time.
- Shutdown: system shuts down and turns off power.
- Restart system: system begins rebooting.
- Switch user: you can use another account to log in.



Figure 4-25

4.3.2 Remote Device

Please refer to chapter 4.3.1.3 for detailed information.

4.3.3 Network

Please refer to chapter 4.3.1.2 for detailed information.

4.3.4 Close

Click it, and then click OK button, system will close all windows.

 **Note**

If you want to close one window, please move your mouse to the right corner of the displayed window and then you can see the  button. Click it, you can close one window.

5 Alarm Input and Output

Before device connection, please make sure:

- **Alarm Input**

Here we take NKB100 as an example.

Please check the alarm type (Normal open/normal close) first. Then set decoder network alarm type. Set decoder alarm type as NO (Normal Open) if it is ground alarm, otherwise set it as NC (Normal Close).

Please note alarm input is active in low voltage, please ground it.

Please use a relay to separate devices, when there are two decoders, or there is one decoder and one another device.

- **Alarm Output**

Do not connect the alarm output port to high power load directly (It shall be less than 1A); it may result in heavy current which may destroy the relay. Please use co contactor to realize the connection between the alarm output port and the load.

- **Sound Ground**

Please make sure the front-end device has earthed. Otherwise it may result in chip damage.

Alarm input type can be NO (normal open) or NC (normal close).

5.1 Alarm Ports

5.1.1 1-Channel 4K High Definition Series/1-Channel 4K (H.265) High Definition Series

The 1-channel 4K high definition series/1-channel 4K (H.265) high definition series product interface is shown as in Figure 5-1.

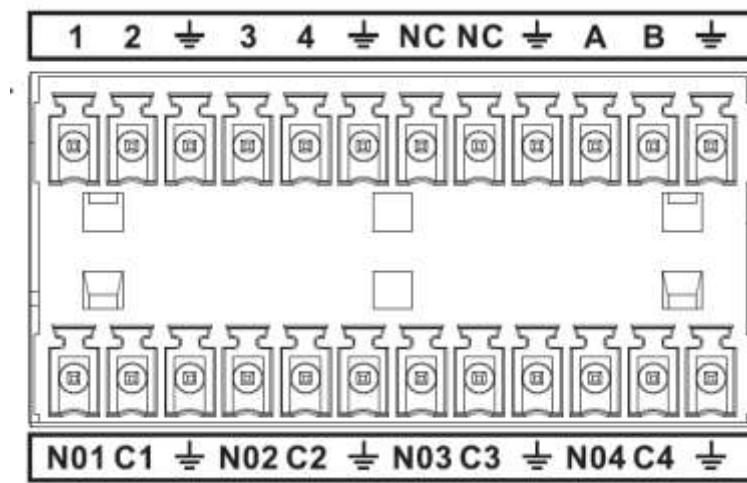

Figure 5-1

Parameter	1-channel 4K high definition series
A,B	Control A, B cable of the RS485 device.
⏏	GND port
1~4	Alarm input port
C1-C4; NO1-NO4	Alarm output port (NO)

5.1.2 4-Channel 4K High Definition Series

The 4-channel 4K high definition series product interface is shown as in Figure 5-2.

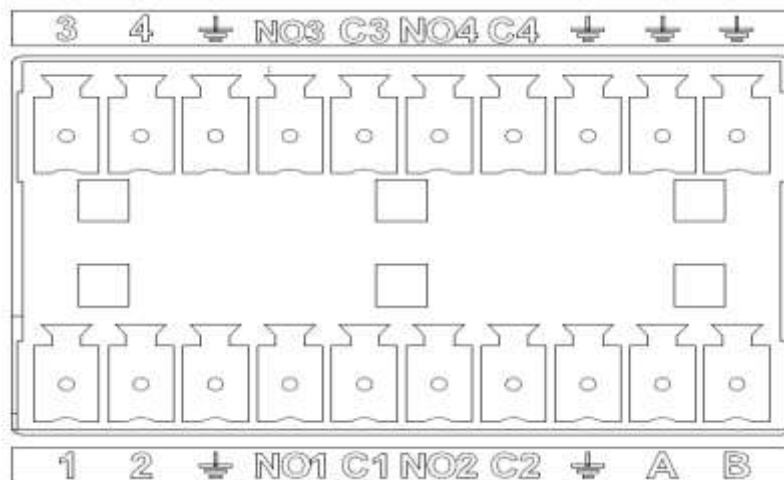

Figure 5-2

Parameter	4-channel 4K high definition series
1-16	Relay input port
⏏	GND port
C1-C8; NO1-NO8	Relay output port(NO)
R0+, R0-, R1+, R1-, T0+, T0-, T1+, T1-	Duplex RS485 port

5.1.3 9-Channel 4K High Definition Series/9-Channel 4K High Definition (With 4 Input Ports) Series/9-Channel High Definition Series

The interface is shown as in Figure 5-3.

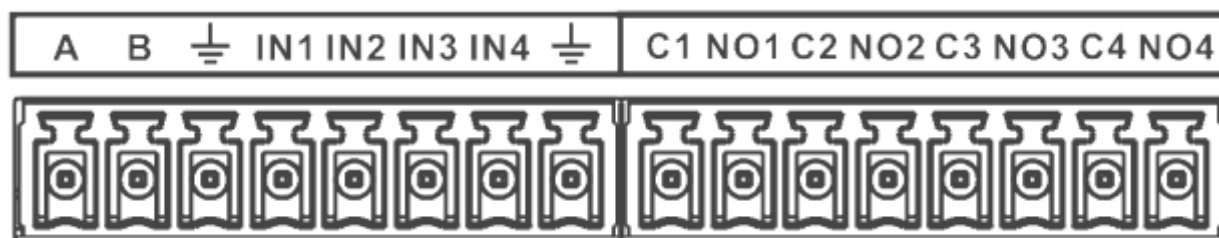

Figure 5-3

Parameter	9-channel 4K high definition series/9-channel 4K high definition (with 4 input ports) series/9-channel high definition series
A,B	Control A, B cable of the RS485 device.
⏏	GND port
IN1-IN4	Alarm input port
C1-C4; NO1-NO4	Alarm output port (NO)

5.1.4 12-Channel 4K High Definition Series/12-Channel 4K High Definition (With 4 Input Ports) Series/15-Channel 4K High Definition Series/15-Channel 4K High Definition (With 4 Input Ports)

Series/18-Channel 4K High Definition Series/18-Channel 4K High Definition (With 4 Input Ports) Series/21-Channel 4K High Definition Series/21-Channel 4K High Definition (With 4 Input Ports) Series

The series interface is shown as in Figure 5-4.

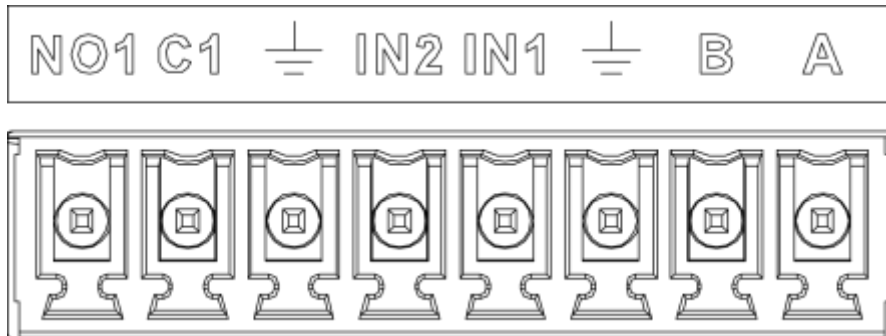

Figure 5-4

Parameter	12-channel 4K high definition series/12-channel 4K high definition (with 4 input ports) series/15-channel 4K high definition series/15-channel 4K high definition (with 4 input ports) series/18-channel 4K high definition series/18-channel 4K high definition (with 4 input ports) series/21-channel 4K high definition series/21-channel 4K high definition (with 4 input ports) series
A,B	Control A, B cable of the RS485 device.
\perp	GND port
IN1-IN4	Alarm input port
C1-C4; NO1-NO4	Alarm output port (NO)

5.2 Alarm Input Port Notice

- There are 16-ch alarm inputs and the input type can be NO or NC.
- Connect the NC port of alarm detector to the device alarm input port (ALARM)
- When using external power to provide power to the alarm device, please make it has the same ground with the device.

Please refer to the following figure for more information. See Figure 5-5.

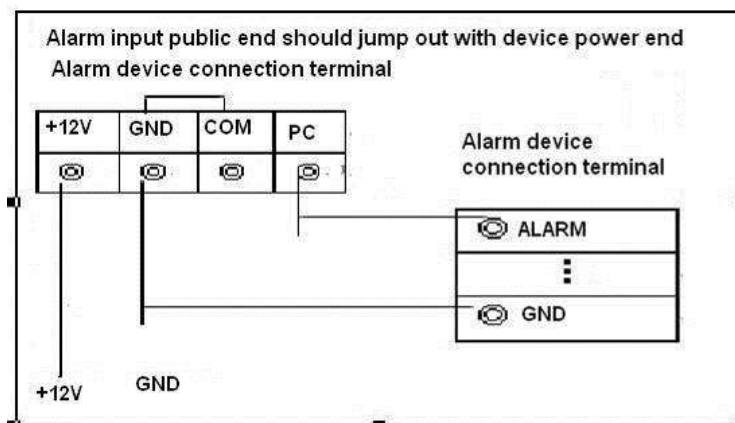

Figure 5-5

5.3 Alarm Output Port

- 8-ch alarm output (normal open contact). The external alarm device needs the battery supported.
- To avoid overload to damage the device, please refer to the following sheet for relay specification information.
- About A/B cable of RS485, they are used to connect to the PTZ decoder A/B cable. Please refer to Figure 5-6 for alarm input module information.

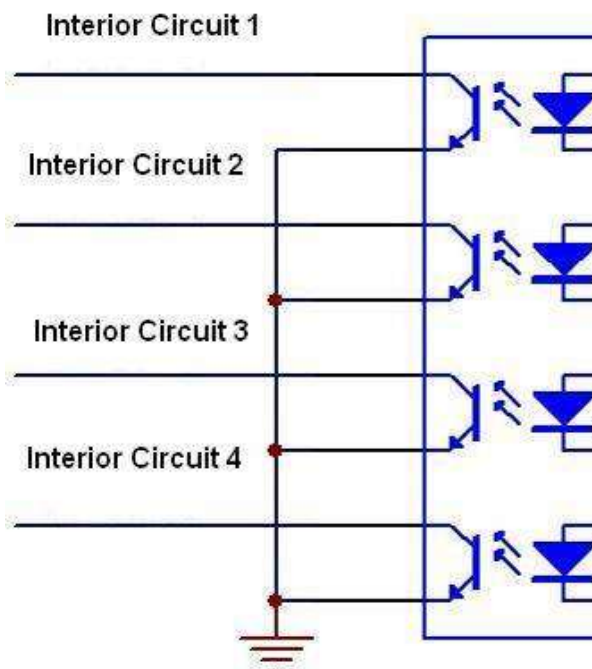

Figure 5-6

Please refer to Figure 5-7 for alarm output module information.

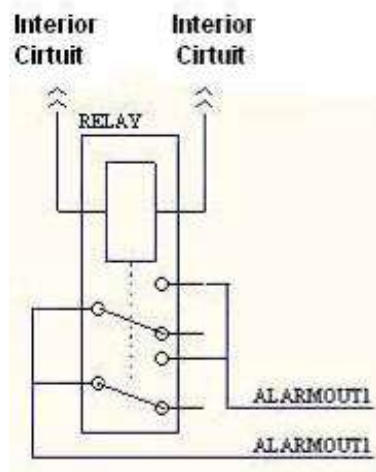

Figure 5-7

5.4 Alarm Output Relay Specifications

Contact Form	1Z
Contact Resistance	100mΩ (0.1A 6VDC)
Contact Material	AgNi+Gilded
Contact Rating (Resistive)	0.5A 125VAC/1A 30VDC
Max. switching voltage	125VAC/60VDC
Max. switching current	2A
Max. switching power	62.5VA/30W
Min. permissible loading	1mA 5V
Mechanical durability	1x10 ⁷ times (300 times/min)
Electrical durability	1x10 ⁵ times (30 times/min)

6 Specifications

6.1 1-channel 4K High Definition /1-channel 4K (H.265) High

Definition Series

System Parameter	Device Model	1-channel 4K high definition series	1-channel 4K(H.265) high definition series
	Main Processor	High performance industry embedded micro processor	
	OS	X86 OS	
	Input Device	Front panel button and keyboard	
	Shortcut Menu	N/A	
Hardware Port Specification	Video Standard	SVAC/MPEG4/H.264/MJPEG/H.265	
	Audio Standard	PCM/G711	
	Decode Display Resolution	QCIF/CIF/2CIF/HD1/D1/960H/720P/1080P/3MP/5MP/6MP/8MP/12MP	
	Video Frame Rate	PAL:1~25f/s; NTSC:1~30f/s	
	Bit stream Type	Composite stream/Video stream	
	Video Output Channel	1 channel	
	Video Output Port	VGA/HDMI	
	Audio Output Channel	1 channel	
	Audio Output Port	HDMI	
	Communication Port	<ul style="list-style-type: none"> ● One RJ45 10M/ 100M/1000M self-adaptive Ethernet port ● One RS232 port ● One RS485 ports (semi-duplex) 	
	Audio Talk Channel	1 channel	
	Audio Talk Port	RCA(Level: 2Vrms. Output resistance : 10kΩ)	
	Alarm input	4 channels	
	Alarm Output	4-ch relay output (30VDC 1A.125VAC 0/5A activation output)	
Working Environment and Other Physical Specification	Power	DC12V, 3.3A	
	Power Consumption	≤20W	
	Working Temperature	-10°C ~ +55°C	

	Working Humidity	10%—95% 86kPa—106kPa
	Dimension (mm)	440×316×44mm
	Weight	3.00 kg—3.50 kg

6.2 4-channel 4K High Definition Series

System Parameter	Device Model	4-channel 4K high definition series
	Main Processor	High performance industry embedded micro processor
	OS	Embedded LINUX
	Input Device	Front panel button and keyboard
	Shortcut Menu	N/A
Hardware Port Specification	Video Standard	MPEG4/H.264/MJPEG/H.265
	Audio Standard	PCM/G711
	Decode Display Resolution	QCIF/CIF/2CIF/HD1/D1/960H/720P/1080P/3MP/5MP/6MP/8MP/12MP
	Video Frame Rate	PAL:1~25f/s; NTSC:1~30f/s
	Bit Stream Type	Composite stream/Video stream
	Audio/video input Channel	1 channel
	Audio/video input Port	HDMI
	Video Output Channel	4 channels
	Video Output Port	VGA/HDMI/BNC
	Audio Output Channel	4 channels
	Audio Output Port	HDMI/BNC(Level: 0.2V~3V, Output resistance: 5kΩ)
	Communication Port	<ul style="list-style-type: none"> ● One RJ45 10M/ 100M/1000M self-adaptive Ethernet port ● One RS232 port ● One RS485 port ● One RJ45 port for screen control
	Audio Talk Channel	1 channel
	Audio Talk Port	BNC(Level: 2Vrms. Output resistance : 10kΩ)
	Alarm input	4 channels

	Alarm Output	4-ch relay output (30VDC 1A.125VAC 0.5A activation output)
Working Environment and Other Physical Specification	Power	DC12V, 5.0A
	Power Consumption	≤40W
	Working Temperature	-10°C ~ +55°C
	Working Humidity	10%—95% 86kPa—106kPa
	Dimension (mm)	440×321.8×44mm
	Weight	3.00 kg—3.50 kg

6.3 9-channel 4K high definition (with 4 input ports)

series/9-channel 4K high definition series

-	Device Model	9-channel 4K high definition (with 4 input ports) series	9-channel 4K high definition series	
System Parameter	Main Processor	High performance industry embedded micro processor		
	OS	Embedded LINUX		
	Input Device	Front panel button and keyboard		
	Shortcut Menu	N/A		
Hardware Port Specification	Video Standard	MPEG2/MPEG4/H.264/H.265/SVAC/MJPEG		
	Audio Standard	PCM/G711/AAC		
	Decode Display Resolution	QCIF/CIF/2CIF/HD1/D1/960H/720P/1080P/3MP/4MP/5MP/6MP/8MP/12MP		
	Video Frame Rate	PAL:1~25f/s; NTSC:1~30f/s		
	Bit Stream Type	Composite stream/Video stream		
	Video Input Port	2-channel DVI-I input , 2-channel HDMI input port	N/A	
	Input Resolutions	Local connection supports: 3840×2160, 1920×1080, 1600×1200, 1680×1050, 1440 ×900, 1400×1050, 1366 ×768, 1280×1024, 1280 × 960, 1280 ×800, 1280×720, 1152×864, 1024×768, 800×600 and etc.	N/A	

-	Device Model	9-channel 4K high definition (with 4 input ports) series	9-channel 4K high definition series
	Video Output Amount	9-channel	
	Video Output Port	HDMI output	
	Audio Output Amount	9-channel	
	Audio Output Port	HDMI	
	Communication Port	<ul style="list-style-type: none"> ● Two RJ45 10M/ 100M/1000M self-adaptive Ethernet ports ● Three RS232 ports (one DB9 port and two RJ45 ports) ● One full-duplex RS485 port 	
	Audio Talk Channel Amount	1-channel	
	Audio Talk Port	3.5mm Jack port Input port: 3.5mm port (Level 2.0V Line in/50mV Mic in, input resistance 10k Ω) Output port: 3.5mm port (Level 2.0V, output resistance 16 Ω)	
	Alarm Input	4-channel	
	Alarm Output	4-ch relay output (30VDC 1A.125VAC 0.5A activation output)	
	USB Port	2 USB ports (1 USB2.0 port, 1 USB3.0 port)	
Working Environment and Other Physical Specification	Power	AC 100V~240V, 50 Hz~60Hz	
	Power Consumption	$\leq 70W$	
	Working Temperature	$-10^{\circ}C \sim +55^{\circ}C$	
	Working Humidity	10%~95% 86kPa~106kPa	
	Dimension (mm)	440mmx408mmx70mm (1.5U height)	
	Weight	4.50kg~4.80kg	

6.4 9/16-channel High Definition Series

System Parameter	Device Model	9-channel high definition series	16-channel high definition series
	Main Processor	High performance industry embedded micro processor	
	OS	Embedded LINUX	
	Input Device	Front panel button and keyboard	
	Shortcut Menu	N/A	

Hardware Port Specification	Video Standard	MPEG4/H.264/ MJPEG	
	Audio Standard	PCM/G711	
	Decode Display Resolution	QCIF/CIF/2CIF/HD1/D1/960H/720P/1080P/3MP/5MP/6MP/8MP	
	Video Frame Rate	PAL:1~25f/s; NTSC:1~30f/s	
	Bit stream Type	Composite stream/Video stream	
	Video Output Channel	9 channels	16 channels
	Video Output Port	VGA/HDMI	VGA/HDMI
	Audio Output Channel	9 channels	16 channels
	Audio Output Port	HDMI/DB15 audio BNC	HDMI/DVI-I audio BNC
	Communication Port	<ul style="list-style-type: none"> ● One RJ45 10M/ 100M/1000M self-adaptive Ethernet port ● One RS232 port ● One standard RS485 port 	<ul style="list-style-type: none"> ● Two RJ45 10M/ 100M/1000M self-adaptive Ethernet ports ● One RS232 port ● One standard RS485 port
	Audio Talk Channel	1 channel	
	Audio Talk Port	3.5mm jack port, input port: 3.5mm port(Level 2V Line in/50mV Mic in, input resistance10k Ω); output port: 3.5mm port(Level 2V, output resistance 16 Ω)	
	Alarm input	4 channels	N/A
	Alarm Output	4-ch relay output (30VDC 1A.125VAC 0.5A activation output)	N/A
Working Environment and Other Physical Specification	Power	AC100-240V, 50Hz~60Hz	
	Power Consumption	$\leq 70W$	$\leq 90W$
	Working Temperature	-10 $^{\circ}C$ ~+55 $^{\circ}C$	
	Working Humidity	10%~95% 86kPa~106kPa	
	Dimension (mm)	440X408X70mm	448 \times 440 \times 89mm
	Weight	4.5kg~4.8kg	7kg~7.5kg

6.5 12/15/18/21-channel 4K High Definition Series

System Parameter	Device Model	12-ch	12-ch with 4 input ports	15-ch	15-ch with 4 input ports	18-ch	18-ch with 4 input ports	21-ch	21-ch with 4 input ports
	Main Processor	High performance industry embedded micro processor							
	OS	Embedded LINUX							
	Input Device	Front panel button and keyboard							
	Shortcut Menu	N/A							
Hardware Port Specification	Video Standard	MPEG2/MPEG4/H.264/H.265/SVAC/MJPEG							
	Audio Standard	PCM/G711/AAC							
	Decode Display Resolution	QCIF/CIF/2CIF/HD1/D1/960H/720P/1080P/3MP/4MP/5MP/6MP/8MP/12MP							
	Video Frame Rate	PAL:1~25f/s; NTSC:1~30f/s							
	Bit stream Type	Composite stream/Video stream							
	Video Input Port	2-channel DVI-IN, 2-channel HDMI port							
	Input Resolution	Local resolution supports 3840×2160, 1920×1080, 1600×1200, 1680×1050, 1440 ×900, 1400×1050, 1366 ×768, 1280×1024,, 1280 × 960, 1280 ×800, 1280×720, 1152×864, 1024×768, 800×600 and etc.							
	Video Output Channel	12-ch	12-ch	15-ch	15-ch	18-ch	18-ch	21-ch	21-ch
	Video Output Port	HDMI							
	Audio Output Channel	12-ch	12-ch	15-ch	15-ch	18-ch	18-ch	21-ch	21-ch
	Audio Output Port	HDMI							
	Communication Port	<ul style="list-style-type: none"> ● Two RJ45 10M/ 100M/1000M self-adaptive Ethernet ports ● Three standard RS232 ports (one DB9 port and two RJ45 ports) ● One semi-duplex 485 port 							
	Audio Talk Channel	1 channel							
	Audio Talk Port	3.5mm jack port, Input port: 3.5mm port(Level 2.0V Line in/50mV Mic in, input resistance10kΩ); Output port: 3.5mm port(Level 2.0V, output resistance 16Ω)							

	Alarm input	2 channels
	Alarm Output	1-ch relay output (DC 30V 1A, AC 125V 0.5A activation output)
Working Environment and Other Physical Specification	Power	AC 100V~127V, 200V~240V, 47 Hz~63Hz
	Power Consumption	≤180W
	Working Temperature	-10°C~+55°C
	Working Humidity	10%—95% 86kPa—106kPa
	Dimension (mm)	440mm×436.6mm×110mm (2.5U height)
	Weight	15kg

**Note:**

- **This manual for reference only. Slight difference may be found in the user interface.**
- **All the designs and software here are subject to change without prior written notice.**
- **All trademarks and registered trademarks mentioned are the properties of their respective owners.**
- **If there is any uncertainty or controversy, please refer to the final explanation of us.**
- **Please visit our website or contact your local retailer for more information.**