

DH-PFB300C

Ceiling Mount Bracket



Features

- Material: Aluminum & PC
- Wall Mount Bracket
- Neat & Integrated design

Specifications

Model	DH-PFB300C
General	
Material	Aluminum & PC
Dimension (W x H x D)	Φ133mm(W) x 235mm(H)
Pipe Thread	1 1/2" PF
Operating Temperature	-40°C ~60°C
Humidity	0~90% RH
Load Bearing	7.0Kg
Weight	0.75kg
Applicable Model	PFA100, PFA101, PFA102, PFA110, PFA111, PFA114

DH-PFB300C

Dimensions (mm)

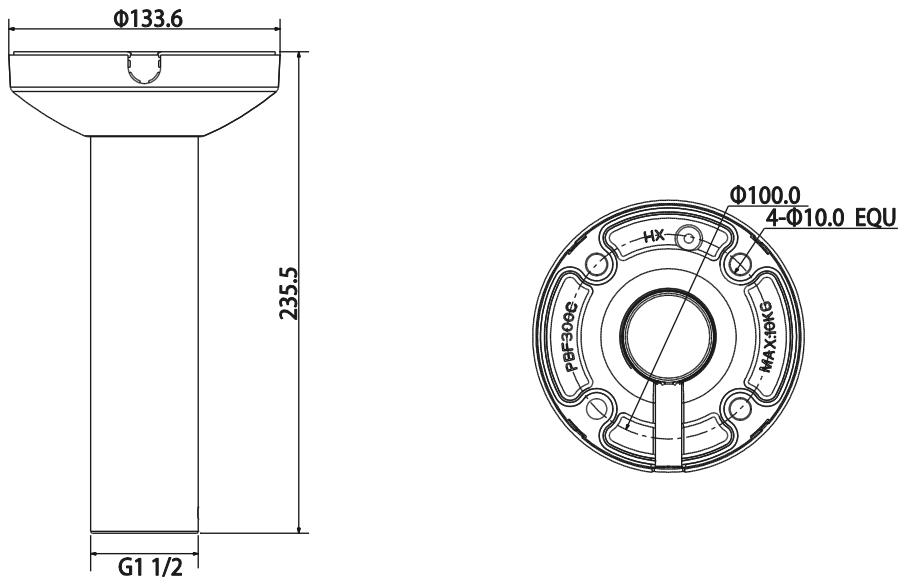

Application

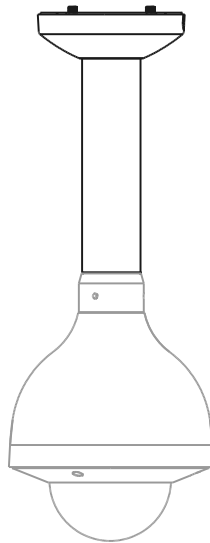

Dahua Technology Co., Ltd.

1187 BinAn Road, Binjiang District, Hangzhou, China

Tel: +86-571-87688883

Fax: +86-571-87688815

Email: overseas@dahuatech.com

www.dahuasecurity.com

*Design and specifications are subject to change without notice.

© 2013 Dahua Technology Co., Ltd.