

DH-HAC-HDBW1100R-VF

1Megapixel 720P Vandal-proof IR HDCVI Dome Camera



Features

- 1/2.9" 1Megapixel CMOS
- 25/30fps@720P
- High speed, long distance real-time transmission
- Day/Night(ICR), AWB, AGC, BLC, 2DNR
- 2.7~12mm vari-focal lens
- Max. IR LEDs length 30m, Smart IR
- IP67, IK10, DC12V

DH-HAC-HDBW1100R-VF

Technical Specifications

Model	DH-HAC-HDBW1100RP-VF	DH-HAC-HDBW1100RN-VF
Camera		
Image Sensor	1/2.9" 1Megapixel CMOS	
Effective Pixels	1280(H)×720(V)	
Electronic Shutter	1/50s~1/100,000s	1/60s~1/100,000s
Video Frame Rate	25fps@720P	30fps@720P
Synchronization	Internal	
Min. Illumination	0.05Lux/F1.4, 0Lux IR on	
Video Output	1-channel BNC HDCVI high definition video output	
Camera Features		
Max. IR LEDs Length	30m, Smart IR	
Day/Night	Auto(ICR) / Color / B/W	
Noise Reduction	2D	
Lens		
Focal Length	2.7~12mm	
Angle of View	H: 93° ~35°	
Lens Type	Manual / Fixed Iris	
Mount Type	Φ14	
General		
Power Supply	DC12V±25%	
Power Consumption	Max 3.2W	
Working Environment	-30°C~+60°C / Less than 95%RH (no condensation)	
Transmission Distance	Over 800m via 75-3 coaxial cable	
Ingress Protection	IP67 & IK10	
Dimensions	Φ122mm×89mm	
Weight	0.45kg	
Material	Metal	

DH-HAC-HDBW1100R-VF

Dimensions (mm)

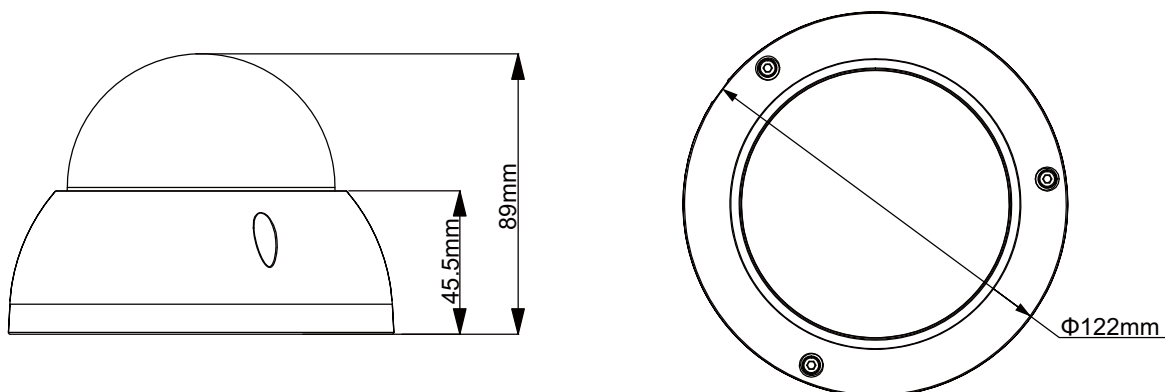

Accessories (optional)

		
PFB203W	PFA137	PFA152

Dahua Technology Co., Ltd.

1199 BinAn Road, Binjiang District, Hangzhou, China

Tel: +86-571-87688883

Fax: +86-571-87688815

Email: overseas@dahuatech.com

www.dahuasecurity.com

*Design and specifications are subject to change without notice.

© 2014 Dahua Technology