

# Villa Door Station (VTO) Baseline (Version 4.3)

## **Quick Start Guide**





# Foreword

## General

This manual introduces the structure, mounting process, and basic configuration of the door station (VTO).

## Safety Instructions

The following categorized signal words with defined meaning might appear in the manual.

Signal Words	Meaning
 <b>WARNING</b>	Indicates a medium or low potential hazard which, if not avoided, could result in slight or moderate injury.
 <b>CAUTION</b>	Indicates a potential risk which, if not avoided, could result in property damage, data loss, lower performance, or unpredictable result.
 <b>NOTE</b>	Provides additional information as the emphasis and supplement to the text.

## Revision History

Version	Revision Content	Release Date
V1.0.0	First release	March 2020

## About the Manual

- The manual is for reference only. If there is inconsistency between the manual and the actual product, the actual product shall prevail.
- We are not liable for any loss caused by the operations that do not comply with the manual.
- The manual would be updated according to the latest laws and regulations of related regions. For detailed information, see the paper manual, CD-ROM, QR code or our official website. If there is inconsistency between paper manual and the electronic version, the electronic version shall prevail.
- All the designs and software are subject to change without prior written notice. The product updates might cause some differences between the actual product and the manual. Please contact the customer service for the latest program and supplementary documentation.
- There still might be deviation in technical data, functions and operations description, or errors in print. If there is any doubt or dispute, please refer to our final explanation.
- Upgrade the reader software or try other mainstream reader software if the manual (in PDF format) cannot be opened.
- All trademarks, registered trademarks and the company names in the manual are the properties of their respective owners.
- Please visit our website, contact the supplier or customer service if there is any problem occurred when using the device.

- If there is any uncertainty or controversy, please refer to our final explanation.

# Important Safeguards and Warnings

The following description is the correct application method of the device. Please read the manual carefully before use to prevent danger and property loss. Strictly conform to the manual during application and keep it properly after reading.

## Operating Requirement

- Do not place and install the device in an area exposed to direct sunlight or near heat generating devices.
- Do not install the device in a humid, dusty or fuliginous area.
- Keep its horizontal installation, or install it at stable places, and prevent it from falling.
- Do not drip or splash liquids onto the device; do not put on the device anything filled with liquids to prevent liquids from flowing into the device.
- Install the device at well-ventilated places; do not block its ventilation opening.
- Use the device only within rated input and output range.
- Do not dismantle the device arbitrarily.
- Transport, use and store the device within allowed humidity and temperature range.

## Power Requirement

- The product shall use electric wires (power wires) required by the region where the device will be used.
- Use power supply that meets SELV (safety extra low voltage) requirements, and supply power with rated voltage that conforms to Limited Power Source in IEC60950-1. For specific power supply requirements, refer to device labels.
- Appliance coupler is a disconnecting device. During normal use, keep an angle that facilitates operation.

# Table of Contents

<b>Foreword</b> .....	<b>I</b>
<b>Important Safeguards and Warnings</b> .....	<b>III</b>
<b>1 Network Diagram</b> .....	<b>1</b>
<b>2 Appearance</b> .....	<b>2</b>
2.1 VTO2101E-P.....	2
2.1.1 Front Panel .....	2
2.1.2 Rear Panel.....	3
2.2 VTO3211D-P.....	3
2.2.1 Front Panel .....	3
2.2.2 Rear Panel.....	4
2.3 VTO2211G/VTO1201G .....	6
2.3.1 Front Panel .....	6
2.3.2 Rear Panel.....	7
<b>3 Installation</b> .....	<b>10</b>
3.1 Notice .....	10
3.2 Guidance.....	10
<b>4 Configuration</b> .....	<b>11</b>
4.1 Configuration Process.....	11
4.2 VDPCConfig .....	11
4.3 Configuring Door Stations (VTO).....	11
4.3.1 Initialization .....	11
4.3.2 Configuring Door Station (VTO) Number .....	12
4.3.3 Configuring Network Parameters .....	13
4.3.4 Configuring SIP Server .....	14
4.3.5 Configuring Call No. and Group Call .....	15
4.3.6 Adding Door Station (VTO).....	15
4.3.7 Adding Room Number .....	17
4.4 Verifying Configuration.....	19
4.4.1 Calling VTH from VTO.....	19
4.4.2 Watching Monitoring Videos on the VTH.....	19
<b>5 App Installation and Adding Device</b> .....	<b>21</b>
5.1.2 Add through Wired Network.....	23
5.1.3 Add through Soft Access Point (AP).....	24
<b>Appendix 1 Cybersecurity Recommendations</b> .....	<b>32</b>

# 1 Network Diagram

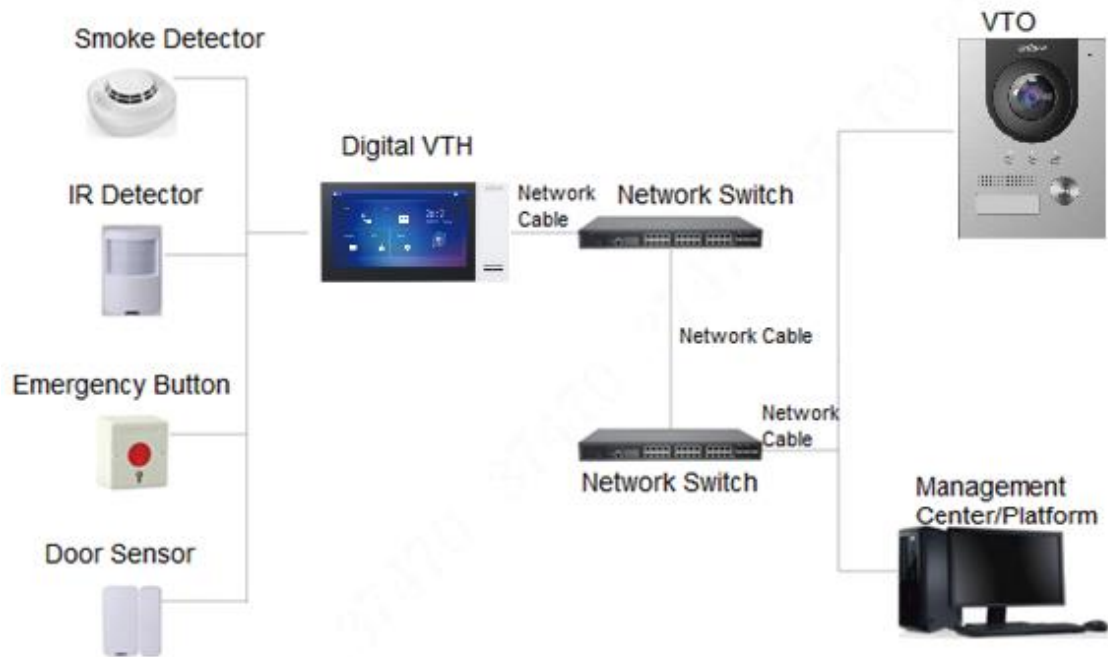

## 2 Appearance

### 2.1 VTO2101E-P

#### 2.1.1 Front Panel

Figure 2-1 VTO2101E-P

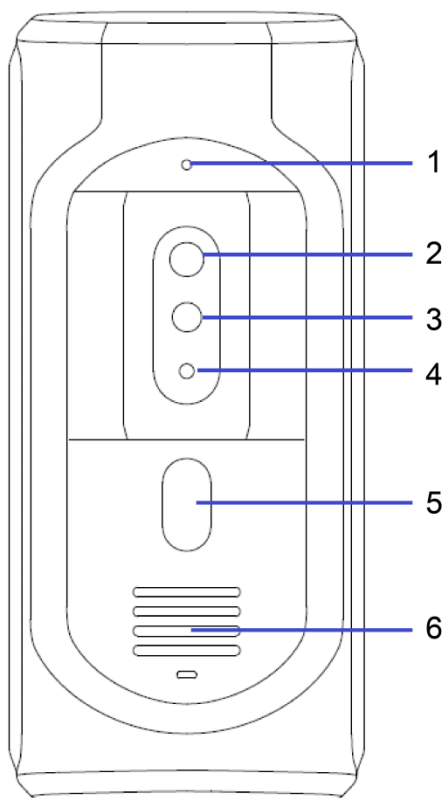

Table 2-1 Front panel description

No.	Name	Description
1	MIC	Inputs audio.
2	Camera	Monitors doorway area.
3	IR illumination light	Provides extra IR light for the camera when it is dark.
4	Light sensor	Detects ambient lighting condition.
5	Call button	Press the button to call VTH or the management center.
6	Speaker	Outputs audio.

## 2.1.2 Rear Panel

Figure 2-2 VTO2101E-P

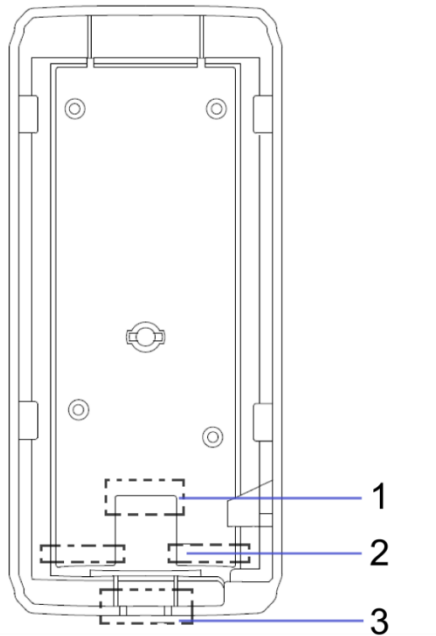

Table 2-2 Rear panel description

No.	Name	Description
1	Network port	Connected to the network with network cables.
2	RS-485 ports	See Figure 2-3 and Table 2-3.
3	Cable tray	You can thread cables through the cable tray.

Figure 2-3 Cable connection

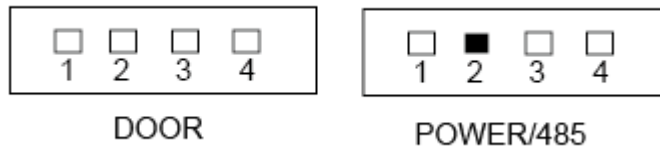

Table 2-3 Port description

DOOR		POWER/485	
No.	Name	No.	Name
1	NO	1	+12V
2	NC	2	GND
3	COM	3	RS-485A
4	ALARM IN	4	RS-485B

## 2.2 VTO3211D-P

### 2.2.1 Front Panel

Number of buttons on the front panel varies on different models. VTO3211D-P2 has two buttons; VTO3211D-P4 has four buttons. VTO3211D-P4 will be taken as an example.



Figure 2-4 VTO3211D-P

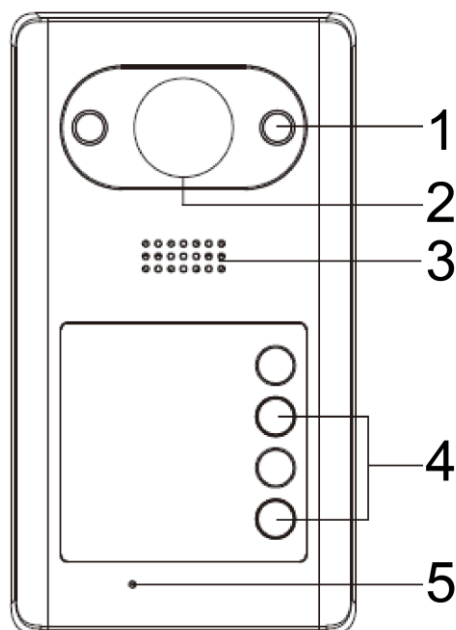

Table 2-4 Front panel description

No.	Name	Description
1	IR illumination light	Provides extra IR light for the camera when it is dark.
2	Camera	Monitors doorway area.
3	Speaker	Outputs audio.
4	Call button	Press the button to call VTH or the management center.
5	MIC	Inputs audio.

## 2.2.2 Rear Panel

Figure 2-5 VTO3211D-P

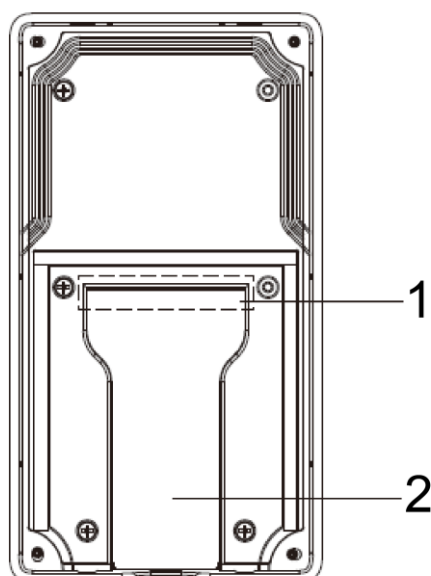

Table 2-5 Rear panel description

No.	Name	Description
1	Cable ports	See Figure 2-6 and Table 2-6.
2	Cable tray	You can thread the cable through the cable tray.

Figure 2-6 Cable connection

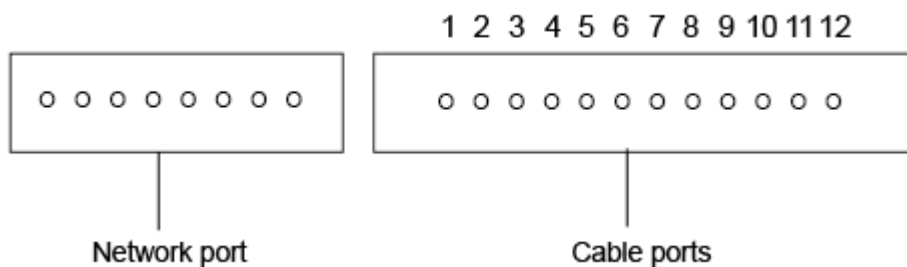

Table 2-6 Cable port description

No.	Name	No.	Name
1	ALM_COM	7	DOOR_FEED
2	ALM_NO	8	DOOR_NC
3	ALM_IN	9	DOOR_COM
4	RS485B	10	DOOR_NO
5	RS485A	11	GND
6	DOOR_OPEN	12	DC 12V

## 2.3 VTO2211G/VTO1201G

### 2.3.1 Front Panel

Figure 2-7 Front panel of VTO2211G/VTO1201G

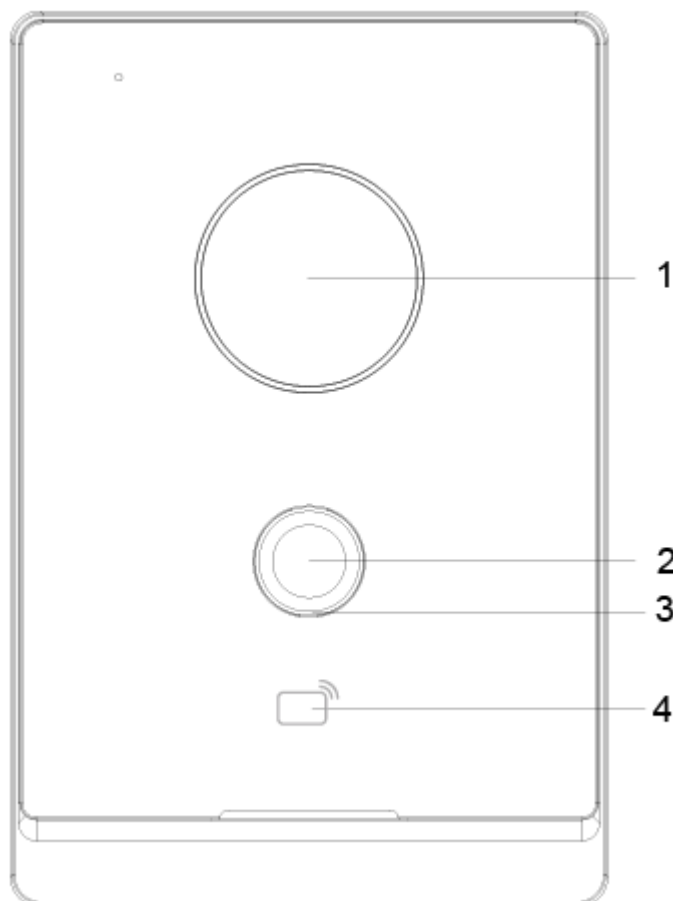

Table 2-7 Front panel description

Name	Description
1	Camera
2	Press the button to call indoor monitor (VTH) or the management center.
3	Indicator light. <ul style="list-style-type: none"> <li>● Off: The device in standby mode;</li> <li>● Solid green: door station (VTO) making a call;</li> <li>● Solid blue: door station (VTO) during a call;</li> <li>● Yellowish green: When you unlock the door through VTH while door station (VTO) is making a call.</li> <li>● Bluish red: When you unlock the door through VTH while you are having a call with the door station (VTO);</li> <li>● Green breathing light: The network is disconnected.</li> </ul>
4	Card reader (only for VTO2211G).

## 2.3.2 Rear Panel

Figure 2-8 Rear panel of VTO2211G/VTO1201G

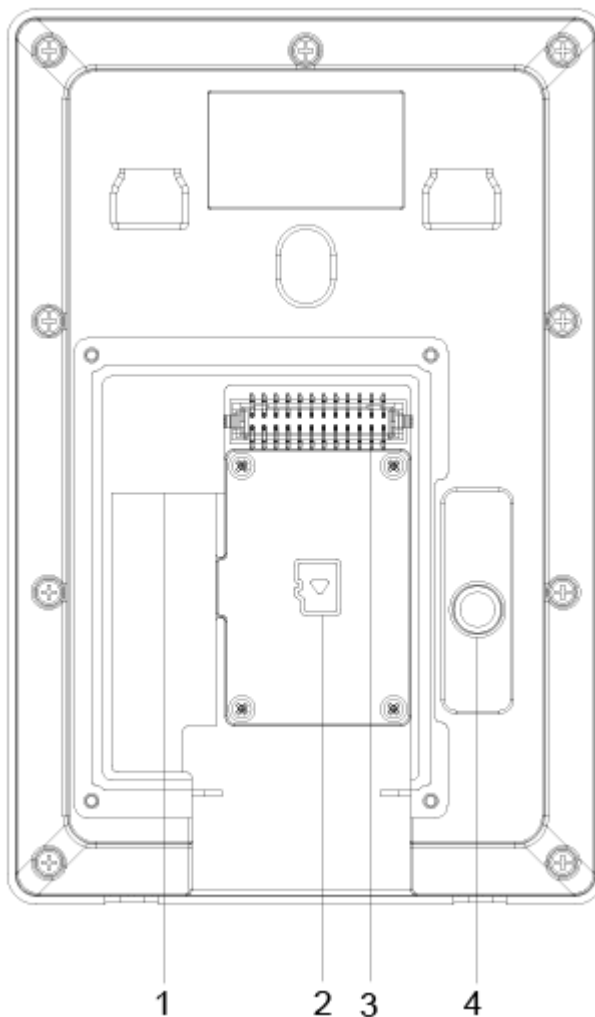

Table 2-8 Rear panel description

No.	Description	No.	Description
1	Network port	3	Ports
2	SD card cover	4	Tamper button

Figure 2-9 VTO2211G cable connection

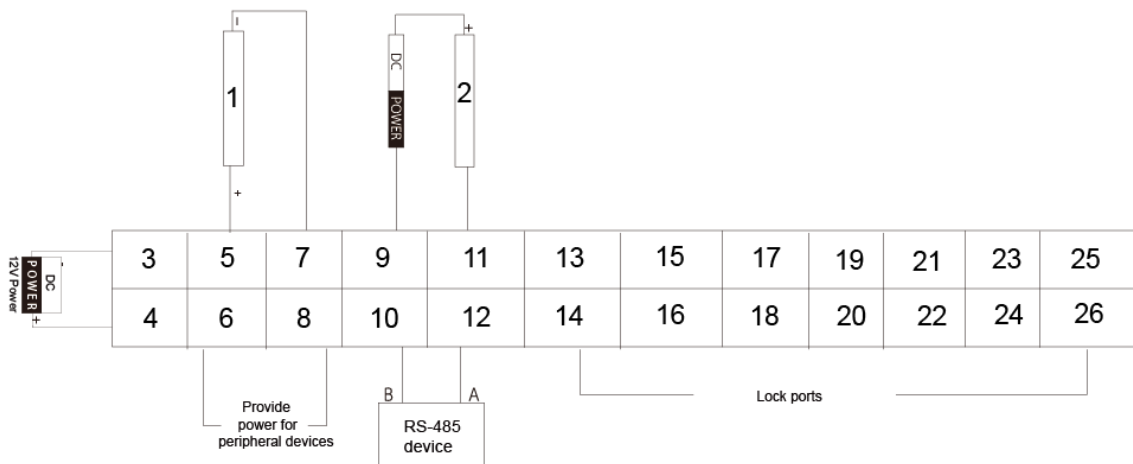

Table 2-9 Port description

No.	Name	No.	Name
1	Alarm input device	14	DOOR1_NC
2	Alarm output device	15	Not available
3	DC_IN-	16	DOOR1_COM
4	DC_IN+	17	Not available
5	ALARM_IN	18	DOOR1_NO
6	+12V_OUT	19	Not available
7	GND	20	GND
8	GND	21	Not available
9	ALARM_NO	22	DOOR1_FB
10	RS485B	23	Not available
11	ALARM_COM	24	GND
12	RS485A	25	Not available
13	Not available	26	DOOR1_PUSH

Figure 2-10 VTO1201G cable connection

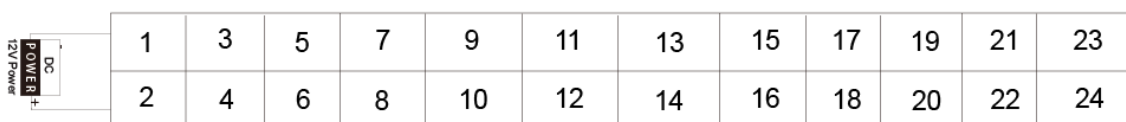

Table 2-10 Port description

No.	Name	No.	Name
1	DC_IN-	13	Not available
2	DC_IN+	14	Not available
3	Not available	15	Not available
4	Not available	16	Not available
5	Not available	17	Not available
6	Not available	18	Not available
7	Not available	19	Not available
8	Not available	20	Not available
9	Not available	21	Not available
10	Not available	22	Not available
11	Not available	23	Not available
12	Not available	24	Not available

Figure 2-11 Connecting lock cables

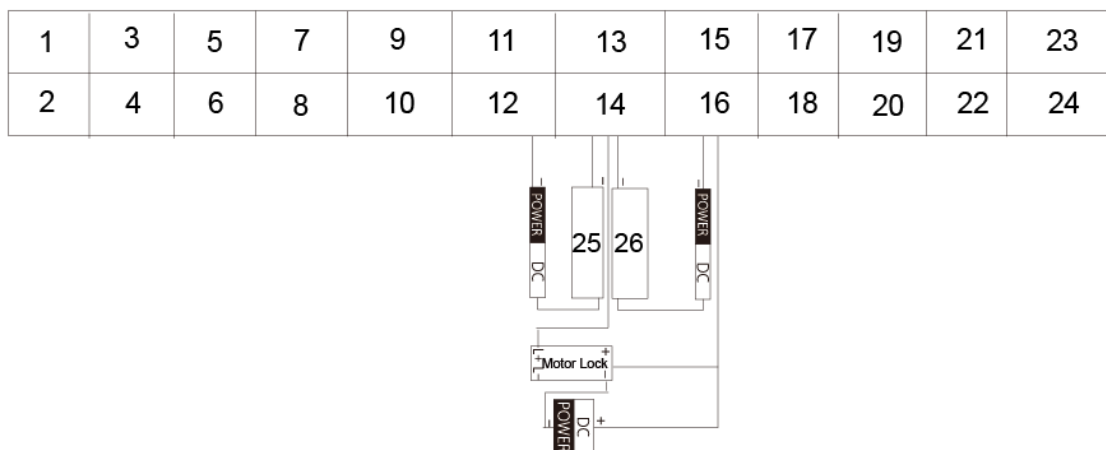

Table 2-11 Port description

No.	Name	No.	Name
1	DC_IN-	14	DOOR1_COM
2	DC_IN+	15	Not available
3	ALARM_IN	16	DOOR1_NO
4	+12V_OUT	17	Not available
5	GND	18	GND
6	GND	19	Not available
7	ALARM_NO	20	DOOR1_FB
8	RS485B	21	Not available
9	ALARM_COM	22	GND
10	RS485A	23	Not available
11	Not available	24	DOOR1_PUSH
12	DOOR1_NC	25	Magnetic lock
13	Not available	26	Electric lock

## 3 Installation

### 3.1 Notice

- Do not install the door station (VTO) at places with condensation, high temperature, grease or dust, chemical corrosion, direct sunlight, or zero shelter.
- The installation and adjustment must be finished by professionals, and do not disassemble the VTO.

### 3.2 Guidance

See Figure 3-1 the installation position. The door station (VTO) horizontal angle of view varies with different models, face the center of the door station (VTO) as much as possible.

Figure 3-1 Installation position reference

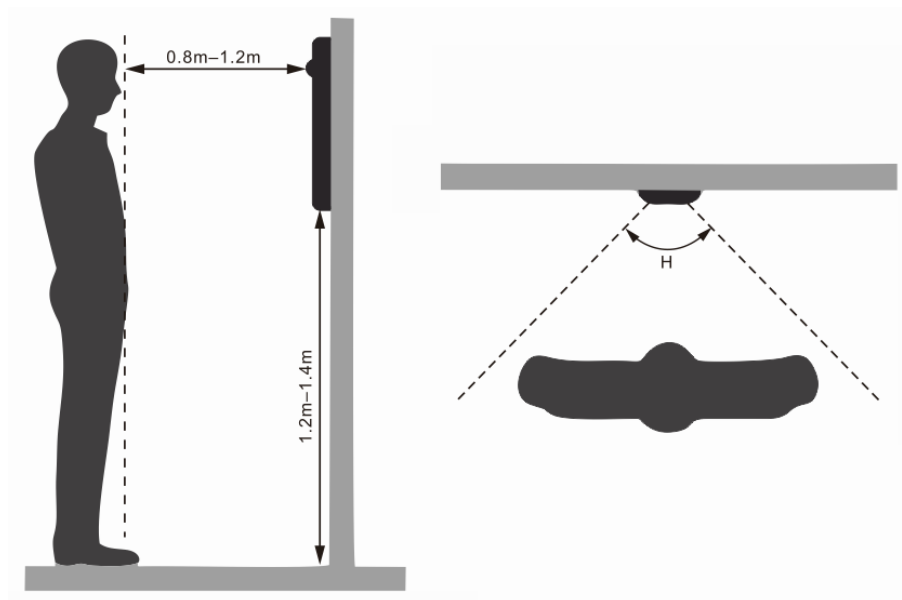

# 4 Configuration

This chapter introduces how to initialize, connect, and make primary configurations to door stations (VTO) and indoor monitors (VTH) to realize basic functions, including device management, calling, and monitoring. For details, see the user manual.

## 4.1 Configuration Process



Before configuration, check each device and make sure there is no short circuit or open circuit.

**Step 1** Plan IP address for each device, and also plan the apartment number and room number you need.

**Step 2** Configure door stations (VTO). See "4.3 Configuring Door Stations (VTO)."

- 1) Initialize door stations (VTO). See "4.3.1 Initialization."
- 2) Configure door station (VTO) numbers. See "4.3.2 Configuring Door Station (VTO) Numbers."
- 3) Configure door station (VTO) network parameters. See "4.3.3 Configuring Network Parameters."
- 4) Configure SIP Server. See "4.3.4 Configuring SIP Server."
- 5) Configure target room number and group call. See "4.3.5 Configuring Call No. and Group Call."
- 6) Add door stations (VTO) to the SIP server. See "4.3.6 Adding Door Station (VTO)."
- 7) Add room number to the SIP server. See "4.3.7 Adding Room Numbers."

**Step 3** Configure indoor monitors (VTH). See the VTH user's manual.

**Step 4** Verify Configuration. See "4.4 Verifying Configuration."

## 4.2 VDPConfig

You can download the "VDPConfig" and perform device initialization, IP address modification and system upgrading for multiple devices at the same time. For the details, see the corresponding user's manual.

## 4.3 Configuring Door Stations (VTO)

Connect the door station (VTO) to your PC with network cable, and for first time login, you need to create a new password for the web interface.

### 4.3.1 Initialization

The default IP address of door station (VTO) is 192.168.1.110, and make sure the PC is in the same network segment as the door station (VTO).

**Step 1** Connect the door station (VTO) to power source, and then boot it up.



**Step 2** Open the internet browser on the PC, then enter the default IP address of the door station (VTO) in the address bar, and then press Enter.

Figure 4-1 Device initialization

**Step 3** Enter and confirm the password, and then click **Next**.

The email setting interface is displayed.

**Step 4** Select the **Email** check box, and then enter your Email address. This Email address can be used to reset the password, and it is recommended to finish this setting.

**Step 5** Click **Next**. The initialization succeeded.

**Step 6** Click **OK**.

Figure 4-2 Login interface

### 4.3.2 Configuring Door Station (VTO) Number

The door station (VTO) number can be used to differentiate each door station (VTO), and it is normally configured according to apartment or building number.



- You can change the number of a door station (VTO) when it is not working as SIP server.
- The door station (VTO) number can contain 5 numbers at most, and it cannot be the same as any room number.

**Step 1** Log in to the web interface of the door station (VTO), and then the main interface is displayed.

Figure 4-3 Main interface

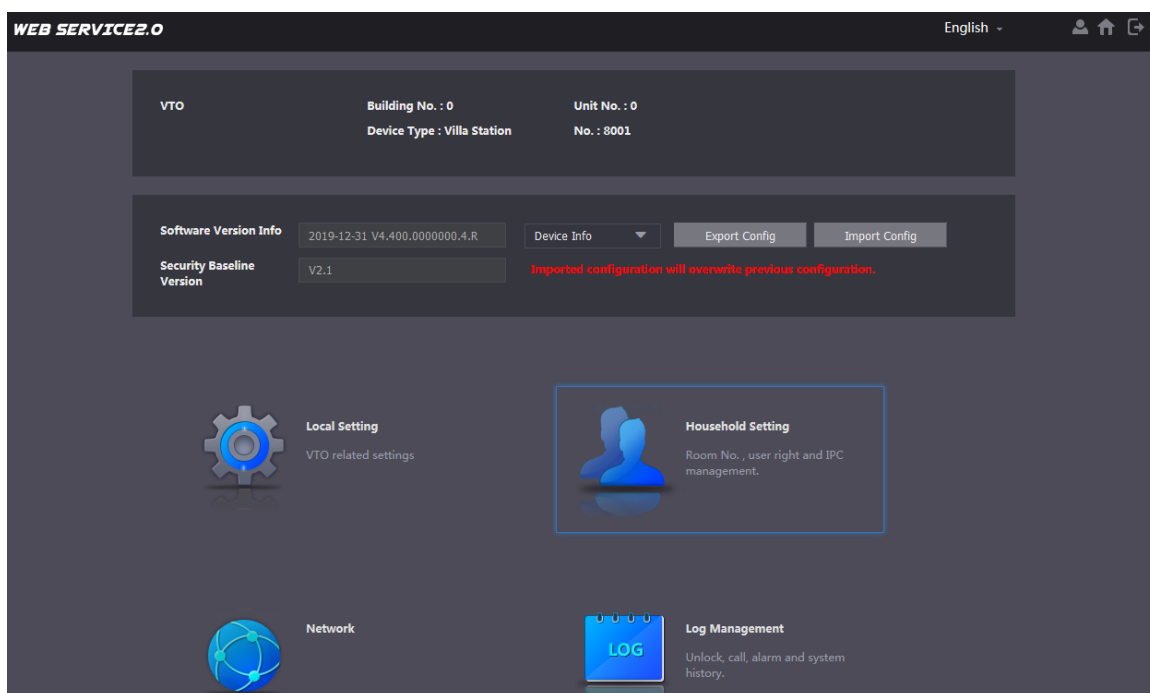

**Step 2** Select Local Setting > Basic.

Figure 4-4 Device properties

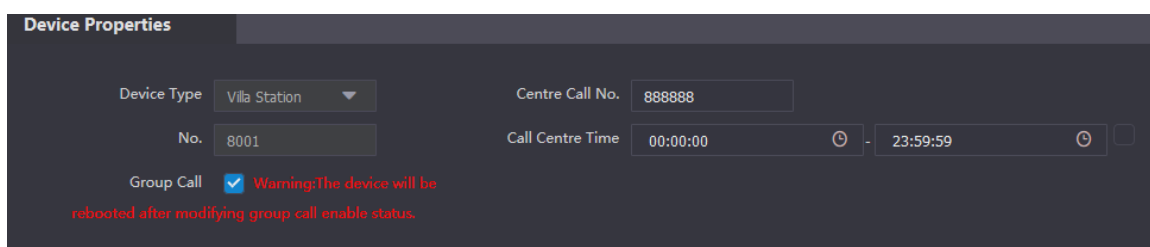

**Step 3** In the **No.** input box, enter the door station (VTO) number you planned for the door station (VTO) you are operating, and then click **Confirm** to save.

### 4.3.3 Configuring Network Parameters

**Step 1** Select Network Setting > Basic.

Figure 4-5 TCP/IP information

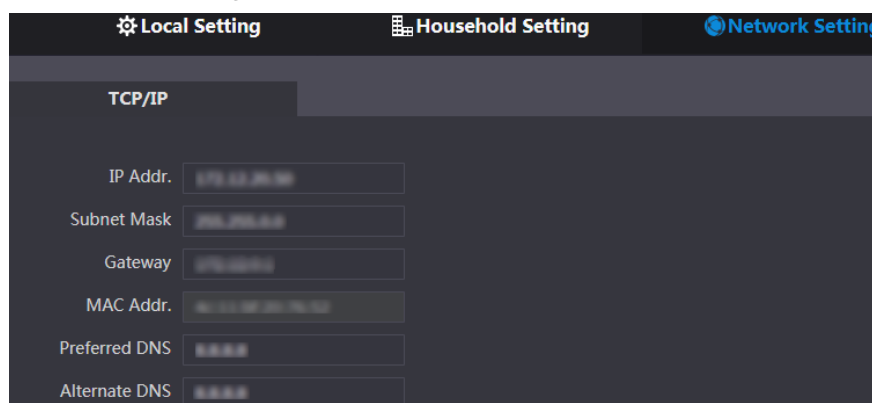

**Step 2** Enter the network parameters you planned, and then click **Save**.

The door station (VTO) will restart, and you need to modify the IP address of your PC to the same network segment as the door station (VTO) to log in again.

### 4.3.4 Configuring SIP Server

The SIP server is required in the network to transmit intercom protocol, and then all the door station (VTO) and indoor monitor (VTH) connected to the same SIP server can make video calls among each other. You can use door stations (VTO) or other servers as SIP server.

Step 1 Select Network Setting > SIP Server.

Figure 4-6 SIP server

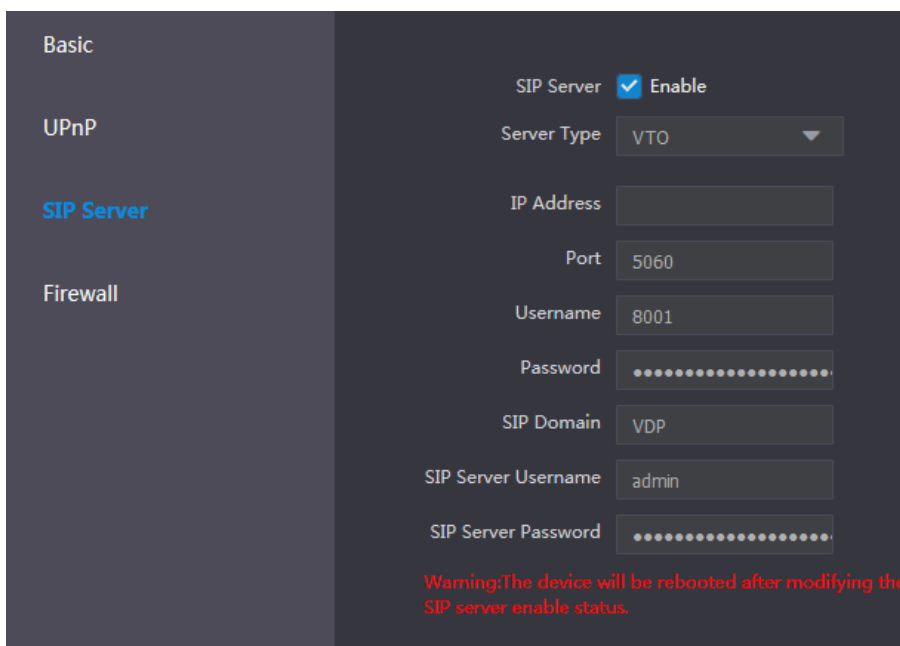

Step 2 Select the server type you need.

- If the door station (VTO) you are visiting works as SIP server  
Select the **Enable** check box at **SIP Server**, and then click **Save**.  
The door station (VTO) will restart, and after restarting, you can then add door stations (VTO) and VTH devices to the door station (VTO) you are operating. See "4.3.6 Adding Door Station (VTO) and 4.3.7 Adding Room Number."



If the door station (VTO) you are visiting does not work as SIP server, do not select the **Enable** check box at **SIP Server**, otherwise the connection will fail.

- If other door station (VTO) works as SIP server  
Select **VTO** in the **Server Type** list, and then configure the parameters. See Table 4-1.

Table 4-1 SIP server configuration

Parameter	Description
IP Addr.	The IP address of the door station (VTO) which works as SIP server.
Port	5060
Username	Keep the default value.
Password	
SIP Domain	VDP

Parameter	Description
SIP Server Username	The user name and password for the web interface of the SIP server.
SIP Server Password	

- If other servers work as SIP server  
Select **Express/DSS** in the **Server Type** list, and then see the corresponding manual for the detailed configuration.

### 4.3.5 Configuring Call No. and Group Call

You need to configure call No. on each door station (VTO), and then all the door stations (VTO) can call the defined room when you press the call button. On the SIP server, you can enable group call function, and when calling a master indoor monitor (VTH), the extension indoor monitors (VTH) will receive the call as well.



After enabling or disabling group call function the door station will restart.

**Step 1** Select Local Setting > Basic.

Figure 4-7 Device properties

**Step 2** In the **No.** input box, enter the room number you need to call, and then click **Confirm** to save. Repeat this operation on every villa door station (VTO) web interface.

**Step 3** Log in to the web interface of the SIP server, and then select **Local Setting > Basic**.

**Step 4** Select the **Group Call** check box, and then click **Confirm**.

The door station (VTO) will restart, and when calling a master indoor monitor (VTH), the extension indoor monitor (VTH) will receive the call as well.

### 4.3.6 Adding Door Station (VTO)

You can add door stations (VTO) to the SIP server, and all the door stations (VTO) connected to the same SIP server can make video calls among each other. This section applies to the condition in which a door station (VTO) works as SIP server, and if you are using other servers as SIP server, see the corresponding manual for the detailed configuration.

**Step 1** Log in to the web interface of the SIP server, and then select **Household Setting > VTO No. Management**.

Figure 4-8 VTO No. management

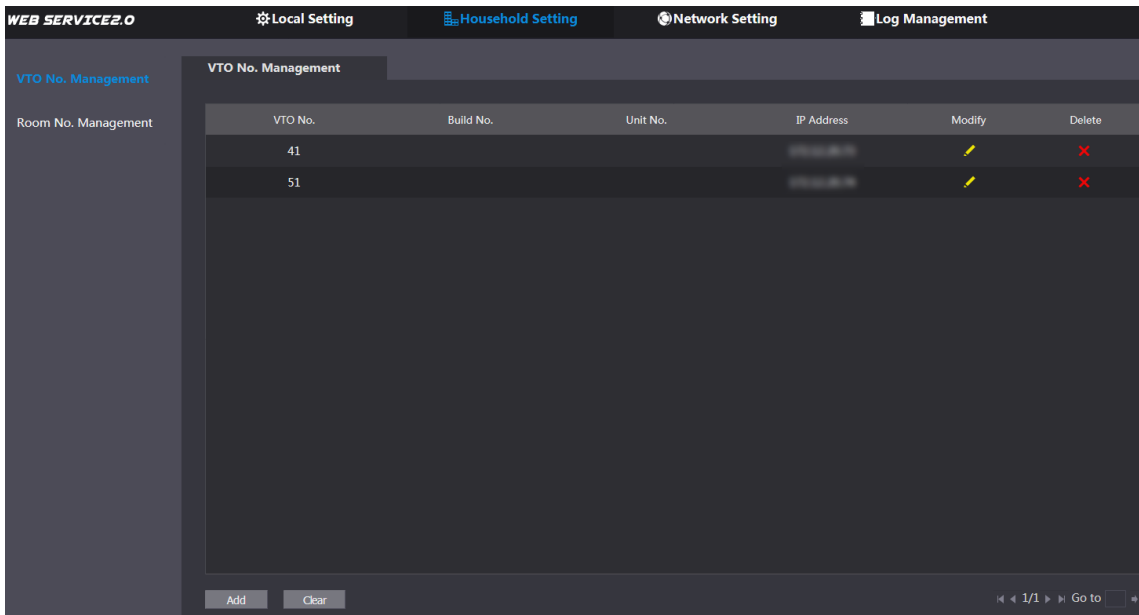

**Step 2** Click **Add**.

Figure 4-9 Add door stations (VTO)

**Step 3** Configure the parameters, and be sure to add the SIP server itself too. See Table 4-2.

Table 4-2 Add door stations (VTO)

Parameter	Description
Rec No.	The door station (VTO) number you configured for the target door station (VTO). See the details in "4.3.2 Configuring Door Station (VTO) Number."
Register Password	Keep default value.
Build No.	Available only when other servers work as SIP server.
Unit No.	
IP Address	The IP address of the target door station (VTO).
Username	The user name and password for the web interface of the target door station (VTO).
Password	

Step 4 Click **Save**.

## 4.3.7 Adding Room Number

You can add the planned room number to the SIP server, and then configure the room number on indoor monitors (VTH) to connect them to the network. This section applies to the condition in which a door station (VTO) works as SIP server, and if you use other servers as SIP server, see the corresponding manual for the detailed configuration.



The room number can contain 6 digits of numbers or letters or their combination at most, and the room number must be unique.

Step 1 Log in to the web interface of the SIP server, and then select **Household Setting > Room No. Management**.

Figure 4-10 Room No. Management

Room No.	First Name	Last Name	Nick Name	Registration Mode	Modify
9901#0				public	
9901#1				public	
9901#2				public	
9901#3				public	
9901#4				public	
9901#5				public	
9901#6				public	
9901#7				public	
9901#8				public	
9901#9				public	

Step 2 Click the **Add**.

Figure 4-11 Add single room number

**Step 3** Configure room information. See Table 4-3.

Table 4-3 Room information

Parameter	Description
First Name	Enter the information you need to differentiate each room.
Last Name	
Nick Name	
Room No.	The room number you planned.  <ul style="list-style-type: none"> <li>If you use multiple indoor monitors (VTH), the room number of the master indoor monitor (VTH) should be "room number#0", and the room number of the extension VTH should be "room number#1", "room number#2", and so on.</li> <li>You can have 9 extension indoor monitors (VTH) at most for one master indoor monitor (VTH).</li> </ul>
Registration Mode	Select <b>public</b> , and <b>local</b> is reserved for future use.
Registered Password	Keep the default value.

**Step 4** Click **Save**.

The added room number is displayed. Click  to modify room information, and click

 to delete a room.

## 4.4 Verifying Configuration

### 4.4.1 Calling VTH from VTO

Press the call button on the door station (VTO) to start a call with the indoor monitor (VTH).

Figure 4-12 Call screen



Tap  on the VTH to answer the call.

### 4.4.2 Watching Monitoring Videos on the VTH

Step 1 In the main interface of the VTH, select **Monitor > Door**.

Figure 4-13 Door

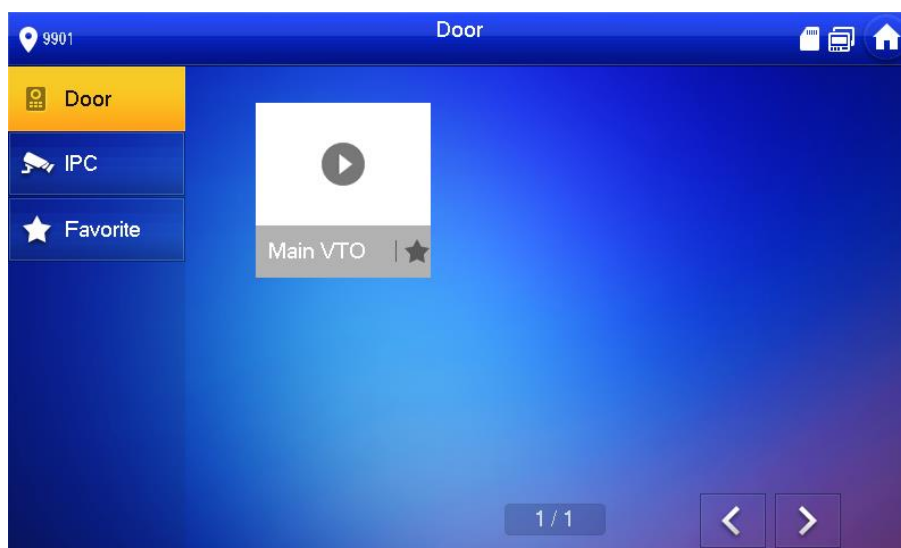

Step 2 Select a door station (VTO) to watch monitoring videos.



Figure 4-14 Watching monitoring videos

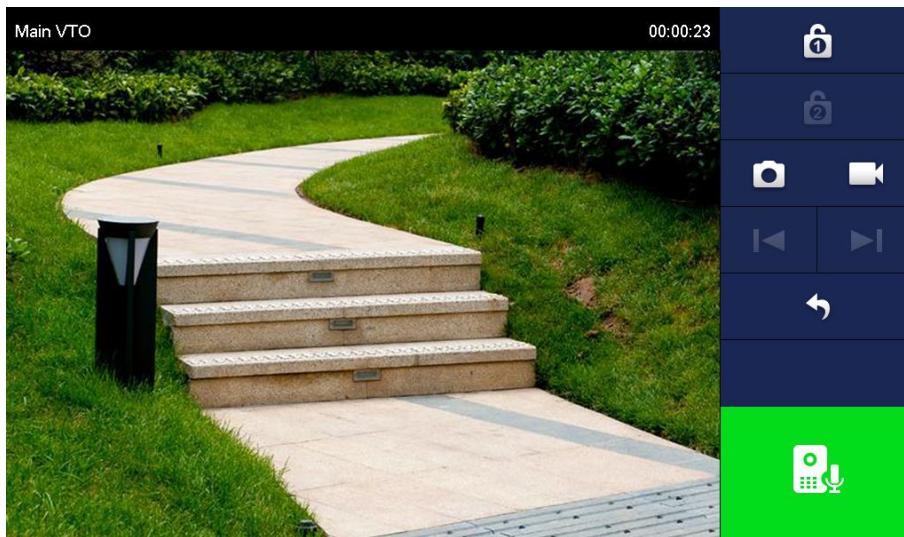

## 5 App Installation and Adding Device

Scan the following QR code to download and install the app.



Before adding the door station (VTO) to the gDMSS Plus, you need to modify IP address of the door station (VTO), make sure that the door station (VTO) and the router are connected to the same network, and connect the door station (VTO) to the power source.

Step 1 On your mobile phone, tap , and then follow the onscreen instructions until the region selection interface is displayed.

Step 2 Select a region.

Step 3 Tap **Done** on the upper right corner of the interface.  
The **Live** interface is displayed.

Figure 5-1 Live

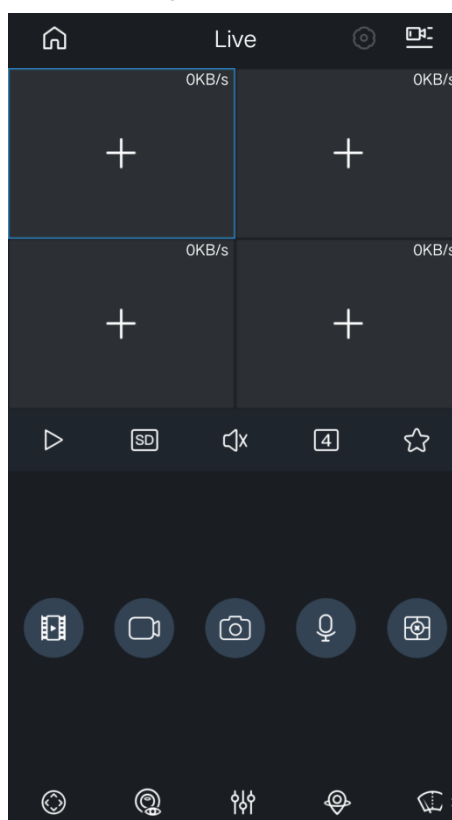



Step 4 Tap  on the upper left corner of the **Live** interface.  
The **Home** interface is displayed.

Figure 5-2 Home

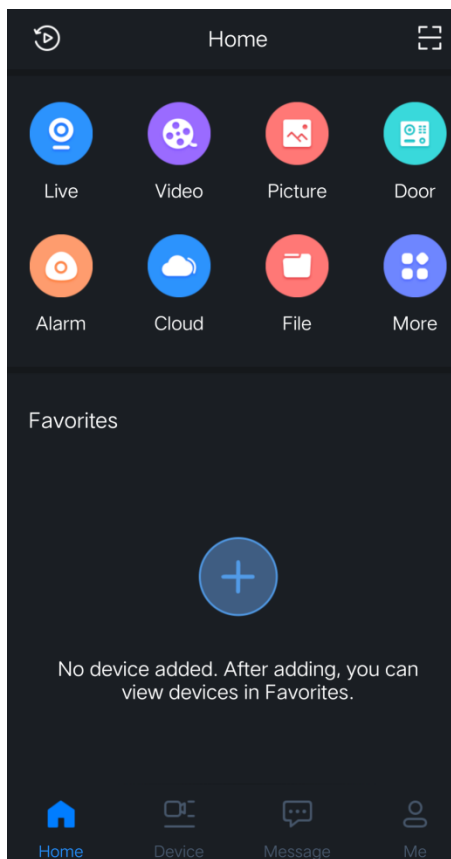

**Step 5** Tap  on the Home interface.

The **Device Manager** interface is displayed.

**Step 6** Tap  on the upper right corner of the **Device Manager** interface.

Figure 5-3 Device manager

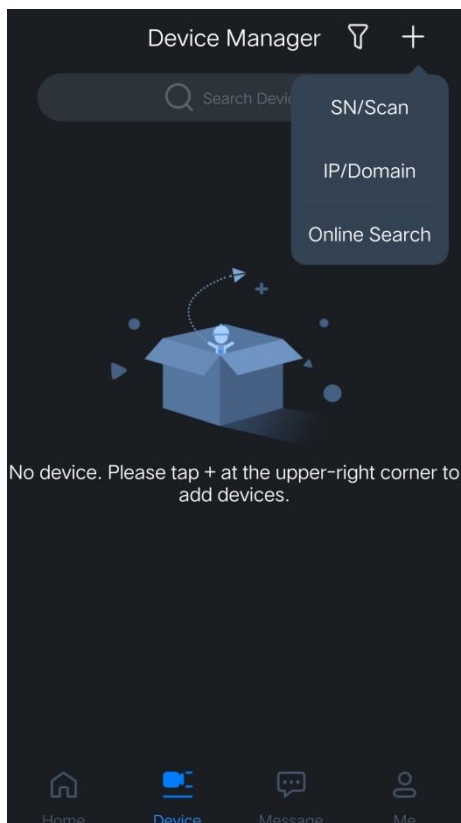

## 5.1.2 Adding through Wired Network

**Step 1** Tap **IP/Domain** on Figure 5-3.

The **Add Device** interface is displayed.

Figure 5-4 Add device

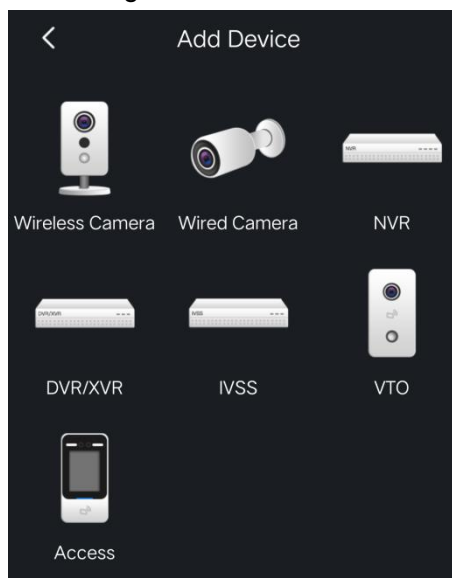

**Step 2** Tap **VTO** on the **Add Device** interface.

The **Add Device** interface is displayed.

Figure 5-5 Add device

 A screenshot of the 'Add Device' interface for VTO configuration. At the top, there is a back arrow, the title 'Add Device', and a save icon. Below the title, there are several configuration fields: 'Add Mode' with the value 'IP', 'Address' (empty), 'Port' with the value '3777', 'Device Name' (empty), 'Username' with the value 'admin', and 'Device Password' (empty) with a show/hide icon.

**Step 3** Enter Address (IP address of the door station (VTO)), Device Name, and Device Password.

**Step 4** Tap .

The door station (VTO) is added. You can watch videos captured by the door station (VTO), call the door station (VTO), unlock doors when there is call from the door station (VTO), and more.

Figure 5-6 Door

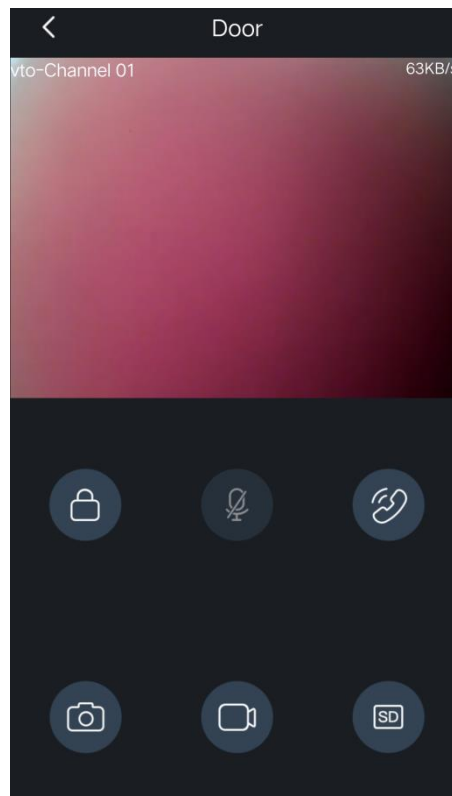

### 5.1.3 Adding through Soft Access Point (AP)

- Step 1 Connect the door station to the power source.
- Step 2 Go to the **WLAN** interface of your mobile phone.
- Step 3 Press and hold the call button on the door station for over 5 seconds until you hear a beep.
- Step 4 Connect your phone to the **VTO2211G-WP\_b67356..** network.

Figure 5-7 Mobile phone WLAN

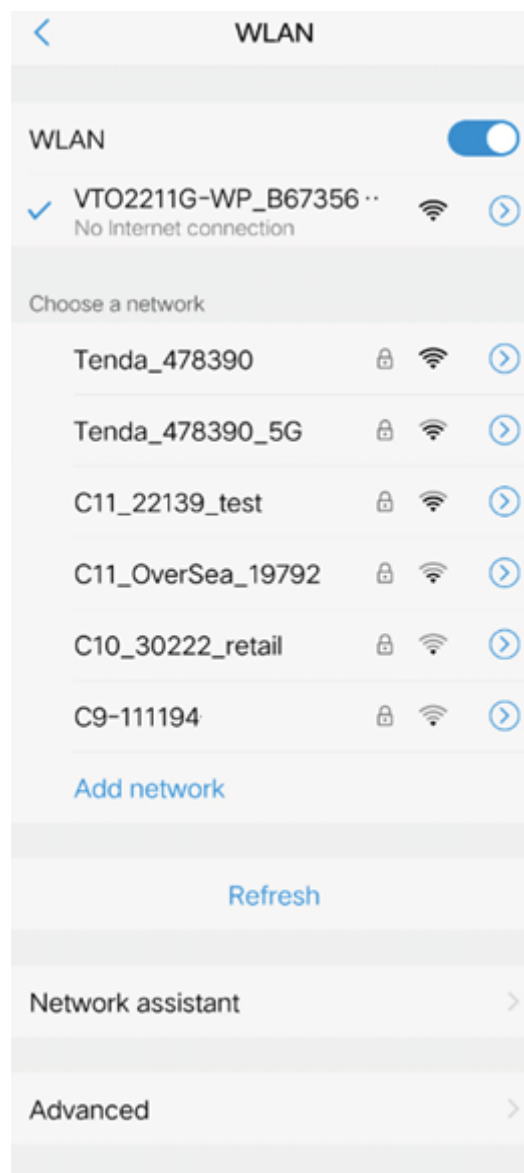

Step 5 Tap  on the upper right corner of the **Device Manager** interface (see Figure 5-3).

Step 6 Tap **SN/Scan** on Figure 5-3.

Figure 5-8 Scan the QR code



Step 7 Scan the QR code at the rear cover of the door station.



The QR code can also be found in **Network > Basic > P2P** on the web interface,

Step 8 Tap **Next**.

Figure 5-9 Add device

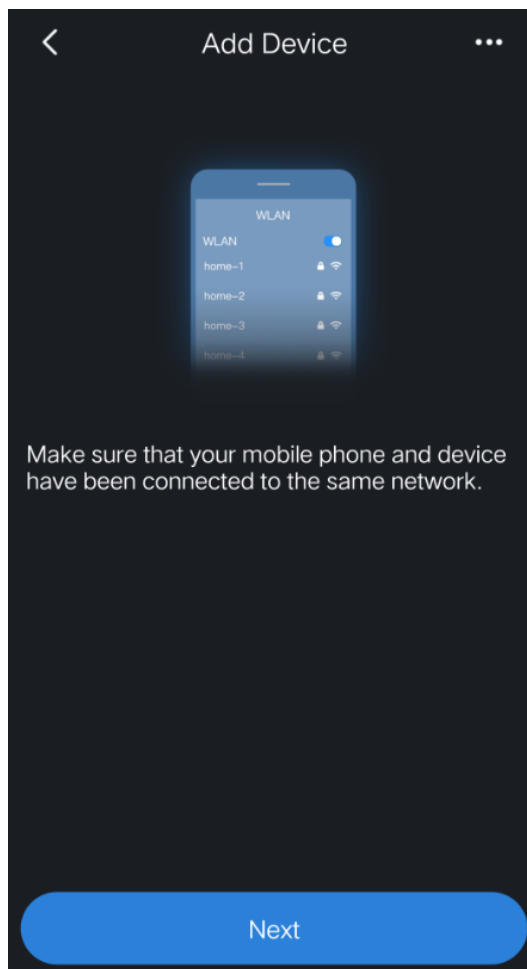

Step 9 Tap  on the upper right corner.



Figure 5-10 Select network configuration mode

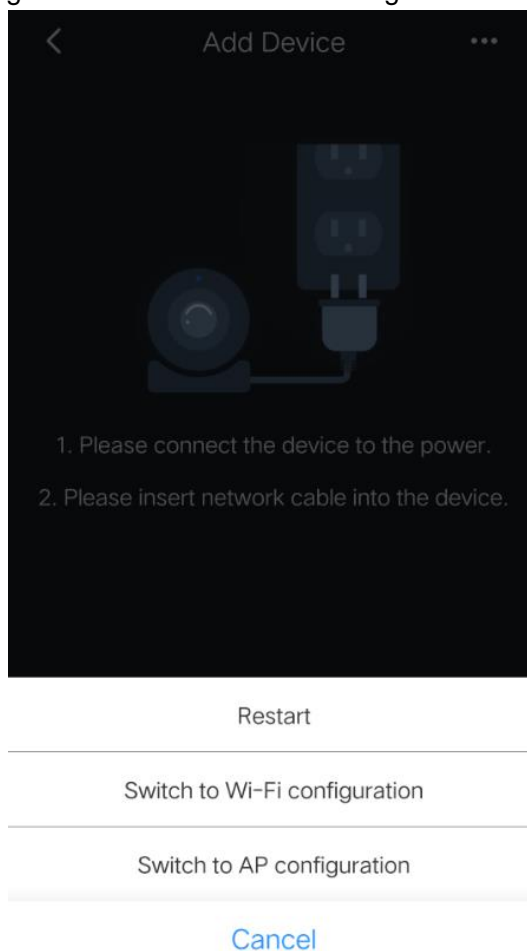

Step 10 Select **Switch to AP Configuration**.

Step 11 Tap **Next**.

Figure 5-11 Set phone network

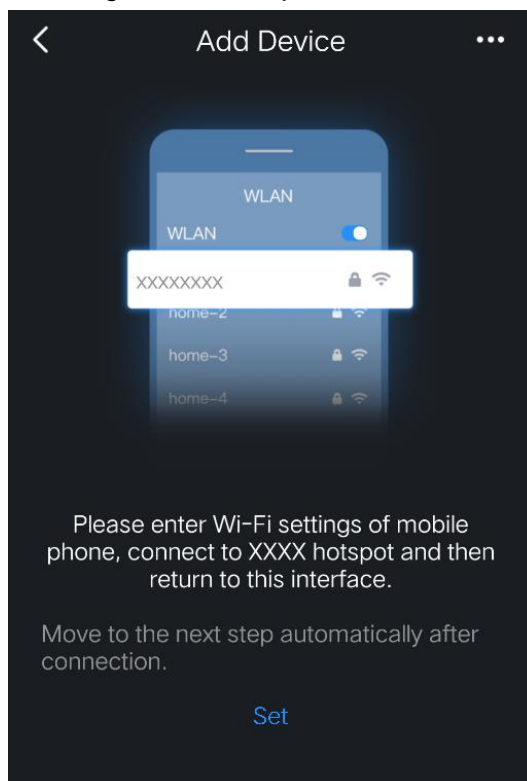

Step 12 Tap **Set**.

Figure 5-12 Select a Wi-Fi

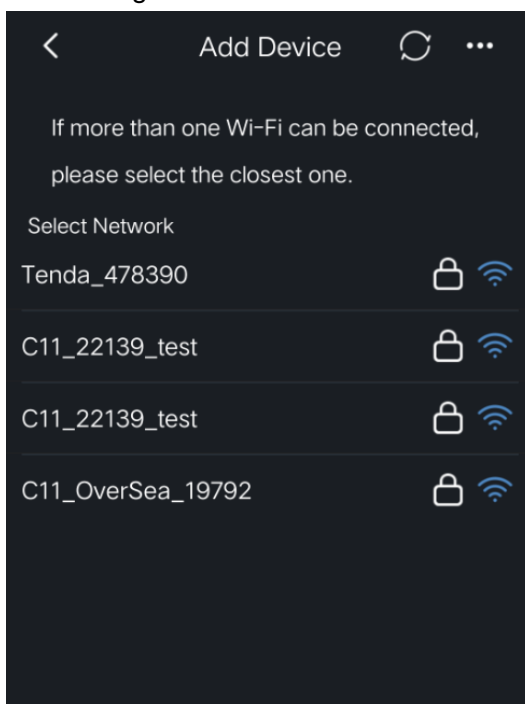

Step 13 Tap a Wi-Fi name.

Figure 5-13 Enter Wi-Fi password



Step 14 Enter the Wi-Fi password.

Step 15 Tap **Next**.

Figure 5-14 Add device

The screenshot shows a dark-themed mobile application interface for adding a device. At the top, there is a back arrow, the title 'Add Device', and a save icon. Below the title, there are several rows of settings:

- Add Mode:** P2P
- SN:** B6735654C5D3235A
- Device Name:** vto (with a close icon)
- Username:** admin
- Device Password:** (with a refresh icon)

At the bottom of the form, there is a warning message: 'Wrong username or password will result in failure to add.' followed by a blue link 'View Reasons'.

Step 16 Enter device name and device password (door station web login password).

Step 17 Tap .

The door station (VTO) is added. You can watch videos captured by the door station (VTO), call the door station (VTO), unlock doors when there is call from the door station (VTO), and more.



After adding door stations to the App, you need to subscribe messages, and then push notifications can be sent to your phone.

Figure 5-15 Door

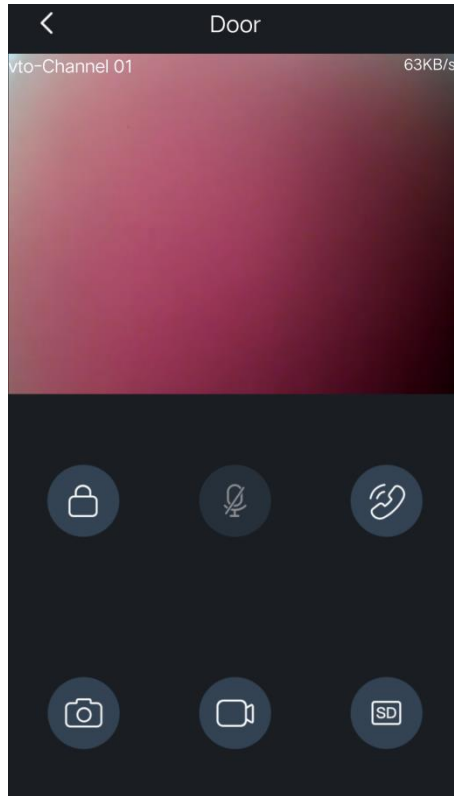

# Appendix 1 Cybersecurity Recommendations

Cybersecurity is more than just a buzzword: it's something that pertains to every device that is connected to the internet. IP video surveillance is not immune to cyber risks, but taking basic steps toward protecting and strengthening networks and networked appliances will make them less susceptible to attacks. Below are some tips and recommendations on how to create a more secured security system.

## **Mandatory actions to be taken for basic equipment network security:**

### **1. Use Strong Passwords**

Please refer to the following suggestions to set passwords:

- The length should not be less than 8 characters;
- Include at least two types of characters; character types include upper and lower case letters, numbers and symbols;
- Do not contain the account name or the account name in reverse order;
- Do not use continuous characters, such as 123, abc, etc.;
- Do not use overlapped characters, such as 111, aaa, etc.;

### **2. Update Firmware and Client Software in Time**

- According to the standard procedure in Tech-industry, we recommend to keep your equipment (such as NVR, DVR, IP camera, etc.) firmware up-to-date to ensure the system is equipped with the latest security patches and fixes. When the equipment is connected to the public network, it is recommended to enable the "auto-check for updates" function to obtain timely information of firmware updates released by the manufacturer.
- We suggest that you download and use the latest version of client software.

## **"Nice to have" recommendations to improve your equipment network security:**

### **1. Physical Protection**

We suggest that you perform physical protection to equipment, especially storage devices. For example, place the equipment in a special computer room and cabinet, and implement well-done access control permission and key management to prevent unauthorized personnel from carrying out physical contacts such as damaging hardware, unauthorized connection of removable equipment (such as USB flash disk, serial port), etc.

### **2. Change Passwords Regularly**

We suggest that you change passwords regularly to reduce the risk of being guessed or cracked.

### **3. Set and Update Passwords Reset Information Timely**

The equipment supports password reset function. Please set up related information for password reset in time, including the end user's mailbox and password protection questions. If the information changes, please modify it in time. When setting password protection questions, it is suggested not to use those that can be easily guessed.

### **4. Enable Account Lock**

The account lock feature is enabled by default, and we recommend you to keep it on to guarantee the account security. If an attacker attempts to log in with the wrong password several times, the corresponding account and the source IP address will be locked.

### **5. Change Default HTTP and Other Service Ports**

We suggest you to change default HTTP and other service ports into any set of numbers between 1024~65535, reducing the risk of outsiders being able to guess which ports you are using.

#### **6. Enable HTTPS**

We suggest you to enable HTTPS, so that you visit Web service through a secure communication channel.

#### **7. Enable Whitelist**

We suggest you to enable whitelist function to prevent everyone, except those with specified IP addresses, from accessing the system. Therefore, please be sure to add your computer's IP address and the accompanying equipment's IP address to the whitelist.

#### **8. MAC Address Binding**

We recommend you to bind the IP and MAC address of the gateway to the equipment, thus reducing the risk of ARP spoofing.

#### **9. Assign Accounts and Privileges Reasonably**

According to business and management requirements, reasonably add users and assign a minimum set of permissions to them.

#### **10. Disable Unnecessary Services and Choose Secure Modes**

If not needed, it is recommended to turn off some services such as SNMP, SMTP, UPnP, etc., to reduce risks.

If necessary, it is highly recommended that you use safe modes, including but not limited to the following services:

- SNMP: Choose SNMP v3, and set up strong encryption passwords and authentication passwords.
- SMTP: Choose TLS to access mailbox server.
- FTP: Choose SFTP, and set up strong passwords.
- AP hotspot: Choose WPA2-PSK encryption mode, and set up strong passwords.

#### **11. Audio and Video Encrypted Transmission**

If your audio and video data contents are very important or sensitive, we recommend that you use encrypted transmission function, to reduce the risk of audio and video data being stolen during transmission.

Reminder: encrypted transmission will cause some loss in transmission efficiency.

#### **12. Secure Auditing**

- Check online users: we suggest that you check online users regularly to see if the device is logged in without authorization.
- Check equipment log: By viewing the logs, you can know the IP addresses that were used to log in to your devices and their key operations.

#### **13. Network Log**

Due to the limited storage capacity of the equipment, the stored log is limited. If you need to save the log for a long time, it is recommended that you enable the network log function to ensure that the critical logs are synchronized to the network log server for tracing.

#### **14. Construct a Safe Network Environment**

In order to better ensure the safety of equipment and reduce potential cyber risks, we recommend:

- Disable the port mapping function of the router to avoid direct access to the intranet devices from external network.
- The network should be partitioned and isolated according to the actual network needs. If there are no communication requirements between two sub networks, it is

suggested to use VLAN, network GAP and other technologies to partition the network, so as to achieve the network isolation effect.

- Establish the 802.1x access authentication system to reduce the risk of unauthorized access to private networks.