

HDCVI Camera

User's Manual







Foreword

General

This manual introduces the functions and operations of the HDCVI camera (hereinafter referred to as "the device").

Safety Instructions

The following categorized signal words with defined meaning might appear in the manual.

Signal Words	Meaning
 DANGER	Indicates a high potential hazard which, if not avoided, will result in death or serious injury.
 WARNING	Indicates a medium or low potential hazard which, if not avoided, could result in slight or moderate injury.
 CAUTION	Indicates a potential risk which, if not avoided, could result in property damage, data loss, lower performance, or unpredictable result.
 TIPS	Provides methods to help you solve a problem or save you time.
 NOTE	Provides additional information as the emphasis and supplement to the text.

Revision History

Version	Revision Content	Release Time
V1.0.0	First release.	June 2020

About the Manual

- The manual is for reference only. If there is inconsistency between the manual and the actual product, the actual product shall prevail.
- We are not liable for any loss caused by the operations that do not comply with the manual.
- The manual would be updated according to the latest laws and regulations of related jurisdictions. For detailed information, refer to the paper manual, CD-ROM, QR code or our official website. If there is inconsistency between paper manual and the electronic version, the electronic version shall prevail.
- All the designs and software are subject to change without prior written notice. The product updates might cause some differences between the actual product and the manual. Please contact the customer service for the latest program and supplementary documentation.
- There still might be deviation in technical data, functions and operations description, or errors in print. If there is any doubt or dispute, we reserve the right of final explanation.

- Upgrade the reader software or try other mainstream reader software if the manual (in PDF format) cannot be opened.
- All trademarks, registered trademarks and the company names in the manual are the properties of their respective owners.
- Please visit our website, contact the supplier or customer service if there is any problem occurring when using the device.
- If there is any uncertainty or controversy, we reserve the right of final explanation.

Important Safeguards and Warnings



Electrical Safety

- All installation and operation should conform to your local electrical safety codes.
- The power source shall conform to the requirement of the Safety Extra Low Voltage (SELV) standard, and supply power with rated voltage which conforms to Limited power Source requirement according to ICE62368-1. Note that the power supply requirement is subject to the device label.
- A readily accessible disconnect device shall be incorporated in the building installation wiring.
- Make sure that the power adapter meets the device operating voltage requirement before powering up the device (The material and length of the power cable might influence the device voltage).
- Prevent the power cable from being trampled or pressed, especially the plug, power socket and the junction extruded from the device.
- We assume no liability or responsibility for all the fires or electrical shock caused by improper handling or installation.

Operating Requirements

- Do not aim the device at strong light to focus, such as lamp light and sun light.
- Transport, use and store the device within the range of allowed humidity and temperature.
- Keep the device away from water or other liquid to avoid damages to the internal components.
- Keep sound ventilation to avoid heat accumulation.
- Heavy stress, violent vibration or water splash are not allowed during transportation, storage and installation.
- Pack the device with standard factory packaging or the equivalent material when transporting the device.
- You are recommended to use the device together with lightning arrester to improve lightning protection effect.
- You are recommended to ground the device to enhance reliability.
- You are recommended to use qualified video transmission cable to improve video quality, and use RG59 coaxial cable or higher standard.



WARNING

- Use standard components or accessories provided by the manufacturer and make sure that the device is installed and maintained by professional engineers.
- The surface of the image sensor should not be exposed to laser beam radiation in an environment where a laser beam device is used.

- Do not provide two or more power supply sources for the device; otherwise it might damage the device.
- If PoC power supply is used, do not connect any other device between the device and PoC transceiver including UTC, Balun, optical transceiver, distributor and convertor and so on; otherwise, the device might get burned.
- PoC supply voltage is up to 52V. Do not dismantle the device during normal operation; otherwise it might cause danger to both device and users due to high voltage.

Table of Contents

Foreword	I
Important Safeguards and Warnings	III
1 Overview	1
1.1 Introduction	1
1.2 Application.....	1
1.3 Transmission Distance.....	2
2 Cable Connection	3
2.1 Power Output.....	3
2.2 12V DC Power Input Port.....	3
2.3 24V AC Power Input Port.....	3
2.4 Video Output Port.....	4
2.5 Audio Input Port.....	4
2.6 Alarm Output Port.....	4
2.7 DIP Switch.....	5
2.8 HD/SD Switch Control Cable	5
2.9 HDCVI Aviation Connector.....	5
3 General Configuration and Operation	7
3.1 Entering XVR Main Menu	7
3.2 Setting Audio Input.....	7
3.3 Operating PTZ Control Panel	8
3.3.1 Operating OSD Menu	8
3.3.2 Operating Auto Focus (AF).....	10
4 Smart Light Camera Configuration	11
4.1 Enabling/Disabling Smart Light.....	11
4.2 Configuring Smart Light Adjustment	11
5 Temperature and Humidity Camera Configuration	12
5.1 Enabling/Disabling Temperature and Humidity.....	12
5.2 Configuring Temperature Measure Mode	12
5.3 Adjusting Temperature and Humidity Display	12
5.4 Viewing Temperature and Humidity	13
6 Active Deterrence Camera Configuration	14
6.1 Detection Range of PIR Detector	14
6.2 Configuring Trigger Mode	14
6.3 Configuring Light Warning and Audio Alarm	15
7 Gateway Camera Configuration	16
7.2 Connecting Node Devices on OSD menu	16
7.3 Connecting Node Devices on XVR.....	16
8 Box Camera Installation	18
8.1 Lens Installation	18
8.1.1 Installing Lens Type 1	18
8.1.2 Installing Lens Type 2	19
8.2 I/O Port Installation	20
8.2.1 Connecting Cable	20
8.2.2 Removing Cable	20

8.3 Device Installation	20
9 Fisheye Camera Configuration	22
9.1 Fisheye Dewarp on the Live Interface	22
9.2 Fisheye Dewarp During Playback.....	23
10 FAQ	24
10.1 PoC Power Supply	24
10.2 Long Distance Power Supply.....	24
10.3 Centralized Power Supply.....	24
10.4 Connector Waterproof Protection	25
11 Maintenance	27

1 Overview

1.1 Introduction

The devices comply with the HDCVI standard and support the transmission of video and control signal over coaxial cable. The devices produce video signal with megapixel resolution and require connected XVRs to achieve high-speed, long-distance, and zero-lag transmission of the signal. They are applicable to various scenes, such as roads, warehouses, underground parking lots, bars, pipelines, and gas stations.

1.2 Application

Figure 1-1 Application scenario

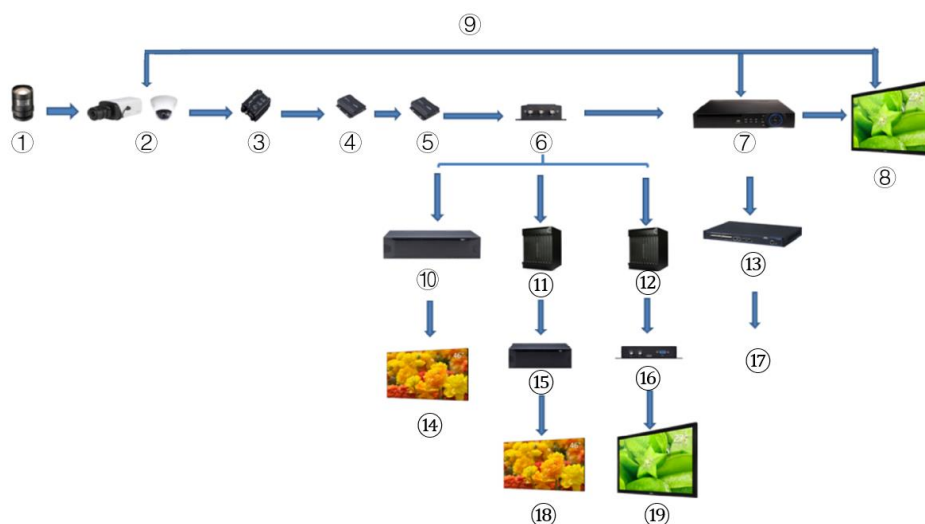

Table 1-1 Application scenario

No.	Name	No.	Name	No.	Name
1	(Optional) Lens	8	Display Screen	15	Splicer
2	HDCVI Products	9	Direct Connection	16	Convertor
3	(Optional) Surge Protection Device	10	Integrated Video Platform	17	Ethernet
4	(Optional) Optical Transceiver (Send)	11	Matrix	18	Splicing Screen
5	(Optional) Optical Transceiver (Receive)	12	Matrix	19	Display Screen
6	(Optional) Distributor	13	Switch	—	—
7	HCVR Products	14	Splicing Screen	—	—

1.3 Transmission Distance

Table 1-2 Transmission distance

Cable		720P	1080P	4MP/4K
Coaxial Cable	RG6 (75-5)	1200 m	800 m	700 m
	RG59 (75-3)	800 m	500 m	500 m
UTP	CAT6	450 m	300 m	300 m

Table 1-3 Transmission distance of PoC HDCVI powered by PoC XVR

PoC XVR Series	PoC Mode	RG59	RG6
Full series	AT	100 m	100 m
	AF	200 m	200 m

2 Cable Connection



Cable types might vary with different cameras, and the actual product shall prevail.

2.1 Power Output

Supplies 12V DC power.



- Ensure that power consumption of devices connected to this port is below 2W.
- Ensure that supply frequency of devices connected to this port is higher than 1MHz, such as sound pick-up, temperature/humidity sensor and other devices without power consumption change. It might cause image flickering if this port is connected to devices with supply frequency less than 1MHz, such as fan, Hall sensor, loudspeaker, motor and other electromechanical devices with power consumption change.

Figure 2-1 Power output



2.2 12V DC Power Input Port

Inputs 12V DC power.



Device abnormality or damage could occur if power is not supplied correctly for 12V DC power input port. Be sure to supply power as instructed in the manual.

Figure 2-2 12V DC power input port



2.3 24V AC Power Input Port

Inputs 24V AC power.



Device abnormality or damage could occur if power is not supplied correctly. Please be sure to supply power as instructed in the manual.

Figure 2-3 24V AC power input port

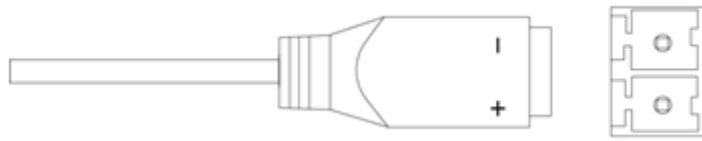

2.4 Video Output Port

Connects to the XVR to output video signal.



WARNING

- When the device is in the condition of PoC power supply, do not connect any other device between the device and PoC XVR or PoC transceiver including UTC, Balun, optical transceiver, distributor and convertor and so on; otherwise, the device might get burned.
- PoC power supply is with high voltage. Do not dismantle the device during normal operation; otherwise it might cause danger to both device and users due to high voltage.

Figure 2-4 Video output port

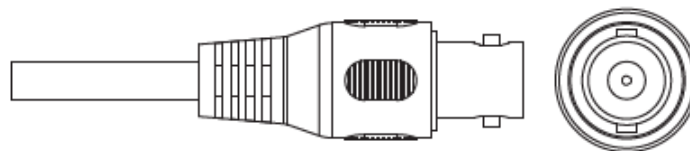

2.5 Audio Input Port

Connects to sound pickup devices to receive analog audio signal.

Figure 2-5 Audio input port



2.6 Alarm Output Port

Connects to external alarm devices such as siren to trigger alarms.

Figure 2-6 Alarm output port

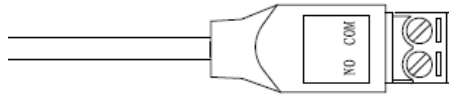

2.7 DIP Switch

Dial switches to change output mode. Switch up indicates "ON", and switch down indicates "OFF."

Figure 2-7 DIP switch

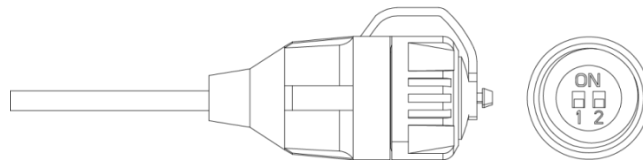

Table 2-1 Operations of DIP switch

Switch1	Switch2	Output Mode
OFF	OFF	CVI
ON	ON	CVBS
ON	OFF	AHD
OFF	ON	TVI

2.8 HD/SD Switch Control Cable

When the HD/SD switch control cable forms a short circuit, video output mode switches from HD to SD. On the contrary, it will switch back to HD video output when the cable forms an open circuit.

Figure 2-8 HD/SD switch control cable

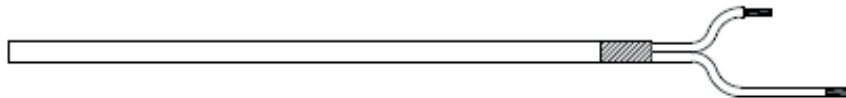

The HD/SD switch control cable is available on select models.

2.9 HDCVI Aviation Connector

Aviation connector could strengthen the connection of mobile devices and provide four ports for your convenience.

Figure 2-9 HDCVI aviation connector

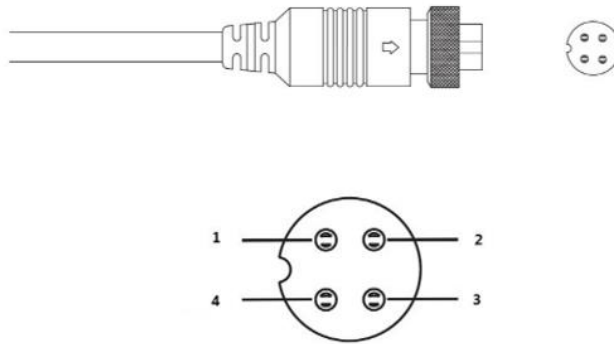

Table 2-2 HDCVI aviation connector components

No.	Name	No.	Name
1	(Yellow): Video	3	(White): Video Ground
2	(Black): Power Ground	4	(Red): Power

3 General Configuration and Operation

Power up the device and connect it to the XVR with coaxial cable, and then the live interface is displayed. Then you can start configuring HDCVI cameras on the XVR.



- The No. of the coaxial ports on XVR will display at the lower-left corner of each window to indicate the corresponding camera.
- Ports might vary depending on the XVR models, and the actual product shall prevail.

3.1 Entering XVR Main Menu

Step 1 Right-click on the live interface, and the shortcut menu is displayed.

Step 2 Click **Main Menu** and then log in to the system. The main menu of XVR is displayed.

Figure 3-1 XVR main menu

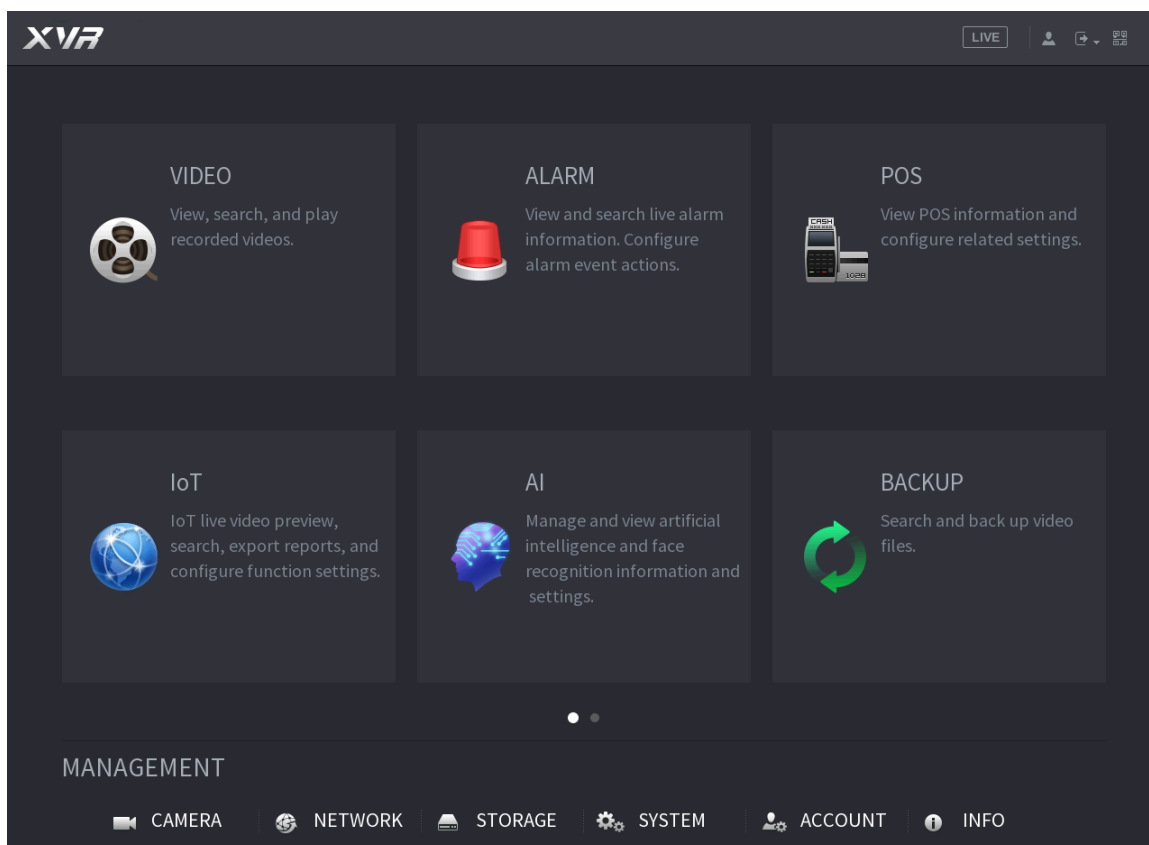

3.2 Setting Audio Input



Audio input is available on select models.

Step 1 On the **Main Menu** interface, select **CAMERA > ENCODE > Encode**.

Step 2 On the **Channel I** drop-down list, select the device that you want to configure according to the coaxial port No.

Step 3 Under **Main Stream**, click **More Setting**.

Figure 3-2 Encode setting

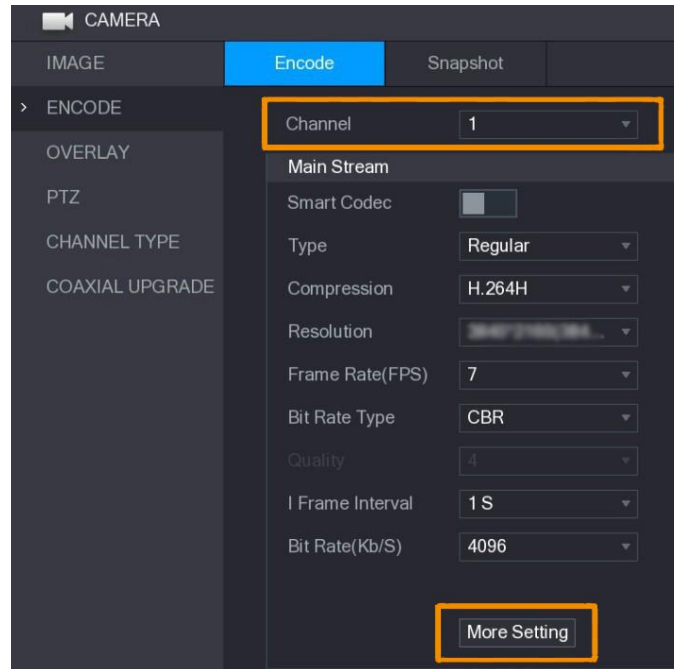

Step 4 On the **More Setting** interface, enable **Audio Encode** function and then configure the audio settings. In the **Audio Format** list, leave it as default; in the **Audio Source** list, select **HDCVI**.

Step 5 Click **Save**.

Figure 3-3 More setting

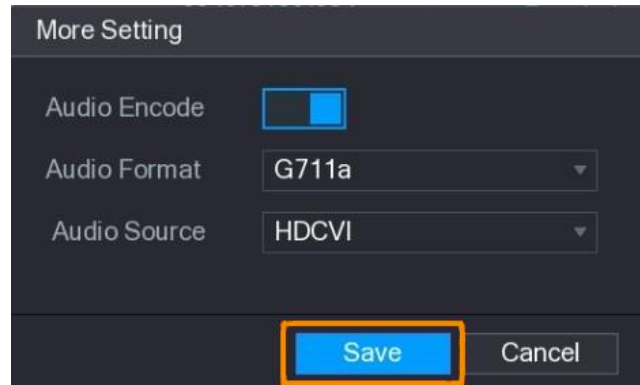

Step 6 On the **Encode** interface, click **Apply**.

3.3 Operating PTZ Control Panel

3.3.1 Operating OSD Menu



- The OSD menus of different cameras might vary, and the actual product shall prevail.
- When you use OSD menu to restore the device to default settings, the resolution, mode, frame rate and language of the device will not be restored.

Step 1 On the live interface, right-click the device that you want to configure. The shortcut menu is displayed.

Figure 3-4 Shortcut menu

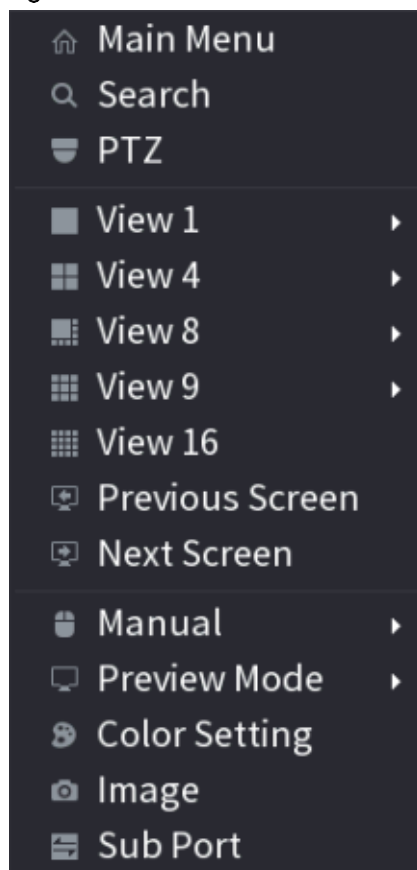

Step 2 Click **PTZ** and click  to extend the menu.

Figure 3-5 PTZ setting options

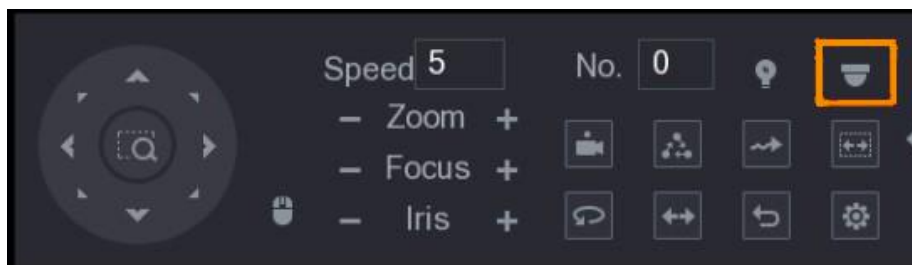

Step 3 Click . The **MENU OPERATION** panel is displayed.

Figure 3-6 Menu Operation panel

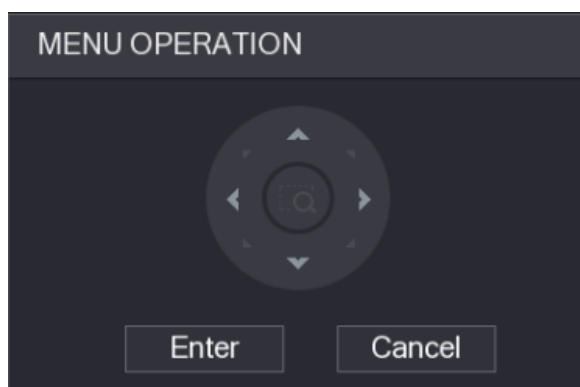



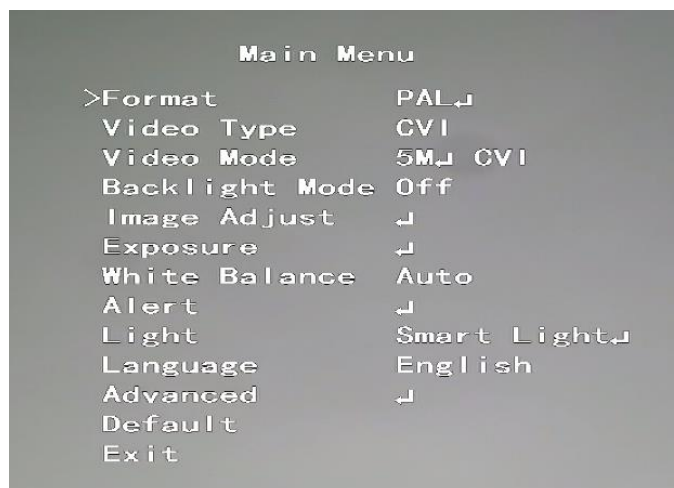

Table 3-1 Menu operation panel function

Button	Function	Button	Function
Enter	Enter or confirm an item	 , 	Select item
Cancel	Exit OSD menu	 , 	Change item value











The OSD menu of the corresponding device is displayed on the live interface. If the value of OSD item is "↵", click **Enter** to go to the next level of this item. Click **Return** to go back to the previous level. Click **Cancel** to exit OSD menu without saving the modifications.

Figure 3-7 OSD menu



3.3.2 Operating Auto Focus (AF)

Table 3-2 Parameter of AF

Parameter	Description
Zoom	 : Zoom out.  : Zoom in.
Focus	 : Focus far.  : Focus near.
Iris	 : Auto focus.  : Open OSD menu.
PTZ movement	Supports eight directions.
	Click  , and then you can control the four directions (left, right, up, and down) of PTZ through mouse operation.
	Click  to unfold PTZ control panel.

4 Smart Light Camera Configuration

This chapter introduces how to configure the working modes of smart light, including auto and manual. Smart light will change the brightness of white light automatically according to the ambient lighting condition to avoid over-exposure. Smart light is only available for full-color camera.

4.1 Enabling/Disabling Smart Light

Smart light is enabled by default. To switch the mode of smart light, enter OSD menu (Figure 3-7) and select **Light > Smart Light**.

4.2 Configuring Smart Light Adjustment

In the smart light mode, configure the maximum brightness level of the smart light, and the device will change brightness automatically according to the ambient lighting condition. You can also configure the sensitivity of the smart light.

Configuring Brightness Level

Step 1 On the OSD menu, select **Light > Smart Light > Level**.

Step 2 Select from **1** to **5** to configure the maximum brightness level.



The maximum brightness level is 5 by default.

Step 3 Click **Return** and then **Exit** to exit the configuration.



You can also configure the brightness level manually in **Light > Manual > Level**.

Configuring Sensitivity

Step 1 Select **Light > Smart Light > Sensitivity**.

Step 2 Select from **1** to **5** to configure the sensitivity value of the smart light.



The higher the value is, the easier the smart light will be woken up.

The sensitivity value is 3 by default.

Step 3 Click **Return** and then **Exit** to exit the configuration.

5 Temperature and Humidity Camera Configuration

Temperature and humidity camera can measure the ambient temperature and humidity and display the value on the live interface.

5.1 Enabling/Disabling Temperature and Humidity

On the OSD menu (Figure 3-7), select **Advanced > Temp. & Humidity** to enable and disable the function. You can view real-time temperature and humidity in the image.

5.2 Configuring Temperature Measure Mode

The temperature and humidity camera supports temperature correction under strong light outdoors. You can change the temperature measurement mode.

Step 1 Enable **Temp. & Humidity**.

Step 2 Select **Standard** or **Sunlight** in the **Measure Mode** to change the temperature measure mode. **Standard** is set by default.



You are recommended to change the mode into **Standard** or **Sunlight** when it is used indoors or outdoors respectively.

5.3 Adjusting Temperature and Humidity Display

Step 1 Select **Advanced > Temperature & Humidity > Location** on the OSD menu.



Make sure that the temperature and humidity function is enabled.

Step 2 Click the direction buttons on the PTZ menu to change the display location.

Step 3 Click **Enter** to save the configuration.

Figure 5-1 Adjust temperature and humidity display



Right-click anywhere on the monitoring image to return to the previous interface after all the settings are completed.

5.4 Viewing Temperature and Humidity

Step 1 Right-click on the live interface to enter XVR main menu (Figure 3-1).

Step 2 Select **IoT > REALTIME DISPLAY**, and then you can view the real-time temperature and humidity.

Figure 5-2 View temperature and humidity

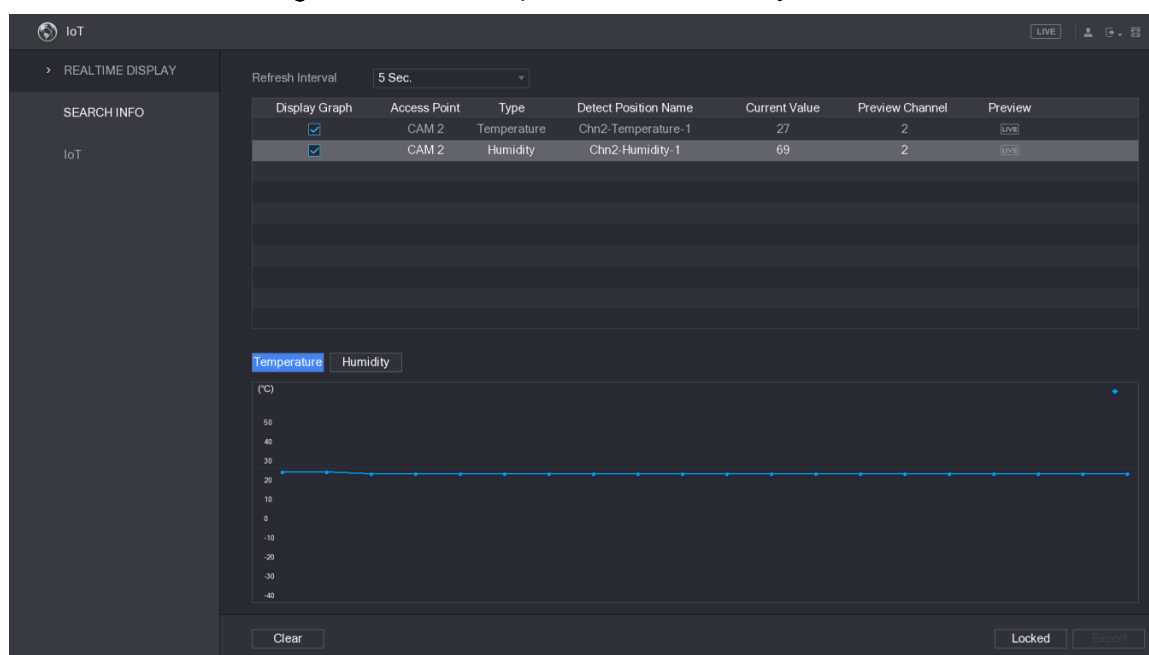

For details, see XVR user's manual.

6 Active Deterrence Camera Configuration

Active deterrence camera can warn off intruders actively with LED even before users are aware of the incidence. Once an intrusion is detected, the LED will be turned on to alert the intruder.

6.1 Detection Range of PIR Detector

The horizontal detection range of the sensor is 100° or 110°.

Figure 6-1 Horizontal detection range

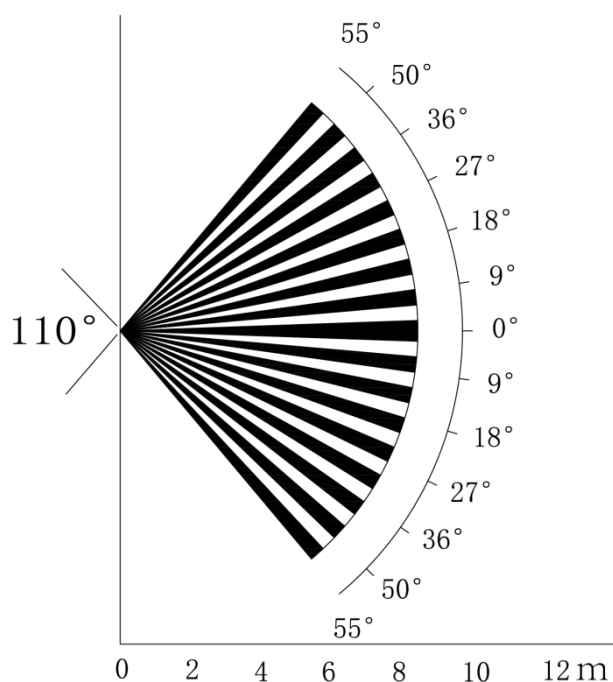

The vertical detection distance of the sensor is 2 m–10 m, 1 m–14 m or 1 m–12 m.

Figure 6-2 Vertical detection distance

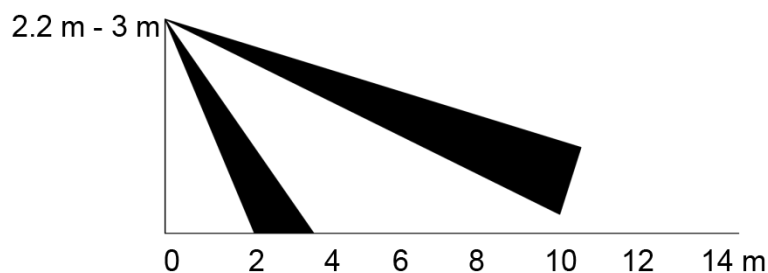

6.2 Configuring Trigger Mode

On the OSD menu (Figure 3-7), select **Alert > Trigger Mode**.

If you select **Camera Set**, the sound and light alarm will be triggered in the device.

If you select **XVR Set**, the sound and light alarm will be triggered in the XVR.



For more information about **XVR Set**, see user's manual of XVR.

6.3 Configuring Light Warning and Audio Alarm



This function is available only when the trigger mode is set to **Camera Set**.

On the OSD menu (Figure 3-7), select **Alert**. Set **Light Warning** to **ON**, and then enter the item.

- ◇ For **Mode**, You can select from **Lighting** to **Flash**.

If you select **Flash**, you can set the **Flash Frequency** to **Low**, **Medium** or **High**.

- ◇ For **Alert Duration**, you can adjust from 5 seconds to 60 seconds.

On the **Audio Alert** item, set it to **ON**, and then enter the item.

- ◇ In the **Audio** item, you can select from three audios.



You can contact after-sales support to customize alarm audios.

- ◇ In the **Volume** item, you can select from **Low**, **Medium** and **High**.
- ◇ In the **Alert Duration**, you can adjust from 5 seconds to 60 seconds.

7 Gateway Camera Configuration



This function is available on select models.

This series of devices can serve as a gateway to connect compatible wireless node devices, including door/window contact, siren, and PIR detector to XVR to form a local alarm network. Once any alarm from devices within the network is triggered, the device transmits alarm signal as configured.

Figure 7-1 Network diagram

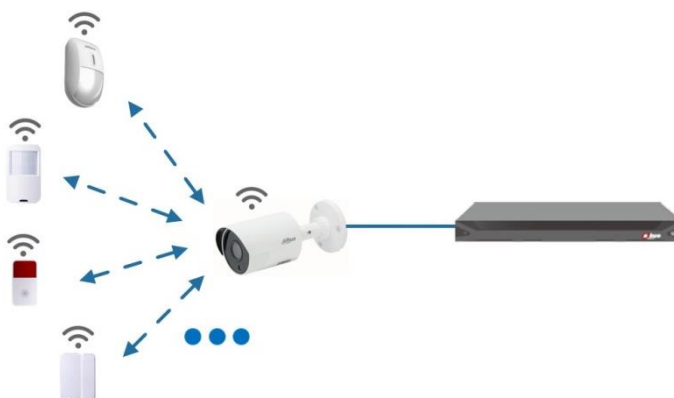

Connect the wireless node devices to XVR with gateway camera and then configure parameters.



For more detailed configuration, see user's manual of XVR or node device.

7.2 Connecting Node Devices on OSD menu

Step 1 On the OSD menu (Figure 3-7), select **Advanced**.

Step 1 Set **Enroll** to **ON**, and the device enters pairing mode.

Operate the node device and enter pairing mode according to corresponding manual.

Step 2 After pairing is completed, you can check the information of the connected device on the **Sensor Pairing** interface.

7.3 Connecting Node Devices on XVR

Step 1 On the XVR Main Menu (Figure 3-1), select **IoT > MANAGER > Sensor Pairing**.

Step 2 Click **Add**.

Figure 7-2 Add sensor pairing (1)

Step 3 In the **Access Type** list, select **Camera Gateway**.

Step 4 Click **Pair**, and the device enters pairing mode.

Operate the node device and enter pairing mode.

Figure 7-3 Add sensor pairing (2)

Step 5 Click **Back**.





Click  to modify the device name; click  to delete node device.

Figure 7-4 Connected device

1	Edit	Delete	Status	Access Type	Access Point	Type
1			●	Camera Gat...	Chn2-Airfly	Panic Button

8 Box Camera Installation



- The device is not equipped with lens when it is delivered out of factory and you need to install lens.
- Do not remove the electrostatic adsorption film on the surface of transparent cover before installation and debugging are completed, which is to avoid damage during installation.
- Install the lens onto the device in time after unpacking, which is to avoid the device module being exposed in humid environment for a long time.
- The mounting surface shall be thick enough to sustain at least 3 times of the device weight.
- Install the C/CS adapter ring to the camera if you are using C mount lens.
- The following installation figure is for reference only.

8.1 Lens Installation

8.1.1 Installing Lens Type 1

Step 1 Remove the protection cap from the device. Align the lens to the lens position of the device (Install the C/CS adapter ring to the device if you are using C mount lens). Turn clockwise to secure the lens firmly.

Step 2 Insert the socket of the lens cable into the auto iris lens connector on the side panel of the device. Skip this step if you are using auto iris lens.

Step 3 Fasten the screw near the focusing ring, and then turn anti-clockwise to move the focusing ring out to focus manually until you get clear video.

Step 4 After you completed focusing, fix the screw near the focusing ring firmly.

Step 5 Fasten the focusing ring.

Figure 8-1 Lens installation (1)

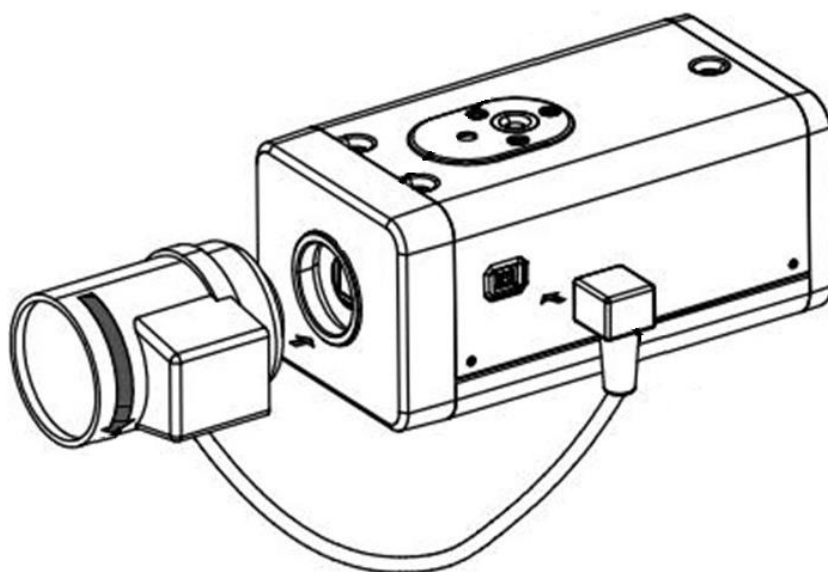

8.1.2 Installing Lens Type 2

Figure 8-2 Front panel

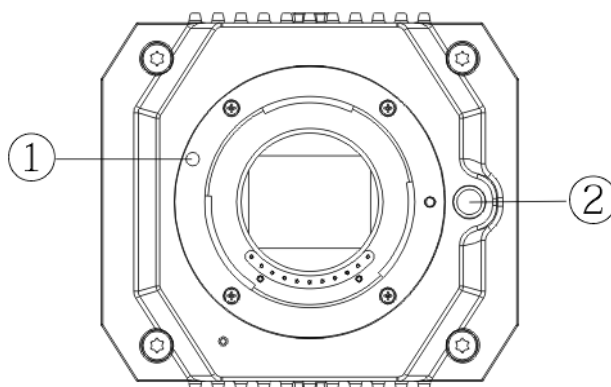

Table 8-1 Front panel components

No.	Name	No.	Name
1	Red sign	2	Lens-dismounting button

Step 1 Remove the protection cover on the device lens, align the red sign of the lens with the red sign ① on the device, rotate the buckle clockwise until the lens-dismounting button ② bounces upward, and then the lens is installed.

Step 2 Loosen the screw on the focusing ring, rotate the focusing ring outward to focus manually until you get clear video. Skip this step if you are using lens that supports auto focusing.

Figure 8-3 Lens installation (2)

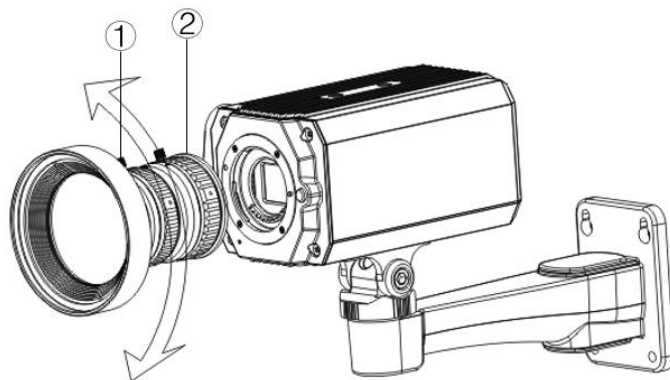

Table 8-2 Lens components

No.	Name	No.	Name
1	Screw	2	Focusing ring

Step 3 After focusing, tighten the screw on the focusing ring and fix the focusing ring.



To dismount the lens, press lens-dismounting button ②, rotate the lens anticlockwise, and release the bucket.

8.2 I/O Port Installation

8.2.1 Connecting Cable

Step 1 Press and hold the mini screwdriver to press the button on the hole groove of the cable to be connected.

Step 2 Insert the cable into the hole groove.

Step 3 Release the screwdriver.

Figure 8-4 Install cable

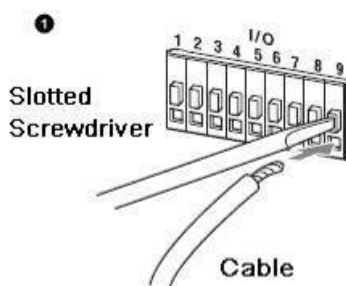

8.2.2 Removing Cable

Step 1 Use the mini screwdriver to press the button on the hole groove of the cable to be connected.

Step 2 Pull out the cable from the hole groove.

Step 3 Release the screwdriver.

Figure 8-5 Remove cable

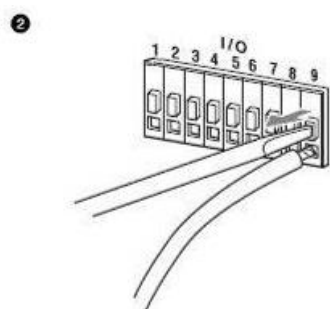

8.3 Device Installation



The device is delivered without mounting bracket and screw. You need to purchase them separately.

Figure 8-6 Device components

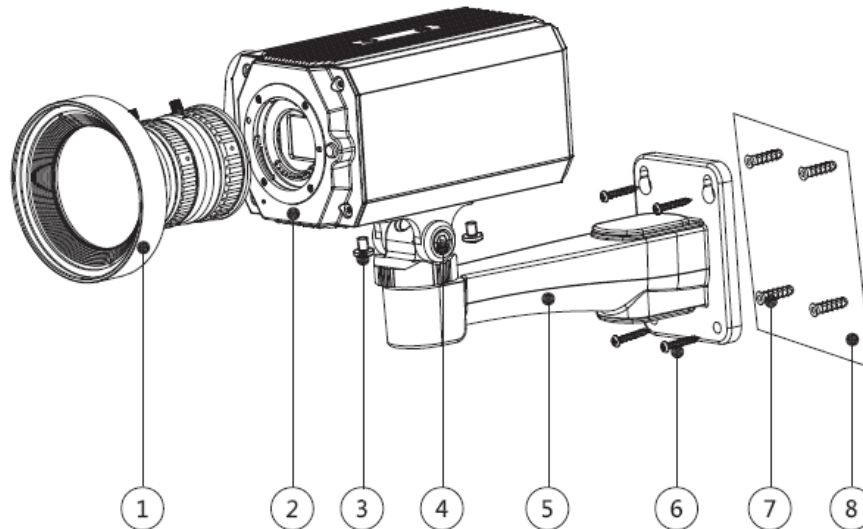

Table 8-3 Device components

No.	Name	No.	Name
1	Lens	5	Mounting bracket
2	Front panel	6	Self-tapping screw
3	Fixing screw	7	Expansion bolt
4	Bracket adjusting screw	8	Mounting surface

Step 1 Fix the mounting bracket ⑤ on the mounting surface ⑧.

- 1) Mark the bracket mounting hole positions on the mounting surface ⑧, drill four holes on the marked positions, insert four expansion bolts ⑦ into the mounting holes and then tighten.
- 2) Align the four screw holes on the bottom of the mounting bracket ⑤ with the expansion bolts, insert four self-tapping screws ⑥ and then tighten.

Step 2 Fix the device on the mounting bracket ⑤.

Align the mounting hole positions on the bottom of device casing with the mounting holes positions on the mounting bracket ⑤, and then install the device on the mounting bracket with fixing screw ③.

Step 3 Adjust camera monitoring angle.

Use a wrench to loosen the adjusting screw ④, adjust camera to the location which needs to be monitored, and then use wrench to tighten bracket adjusting screw ④ to fix the device.

Step 4 Connect the cable to the back panel of the device.

After device installation and cable connection, you can view monitoring image through storage device such as XVR.

9 Fisheye Camera Configuration

The fisheye camera (panoramic camera) has wide monitoring angle but its video is distorted. The dewarp function can provide the proper and vivid video suitable for human eyes. Fisheye function should be configured at XVR.

9.1 Fisheye Dewarp on the Live Interface

Step 1 On the XVR shortcut menu, select **Fisheye**.

Step 2 Set fisheye **Fit Mode** and **Show Mode**.

Figure 9-1 Fisheye menu

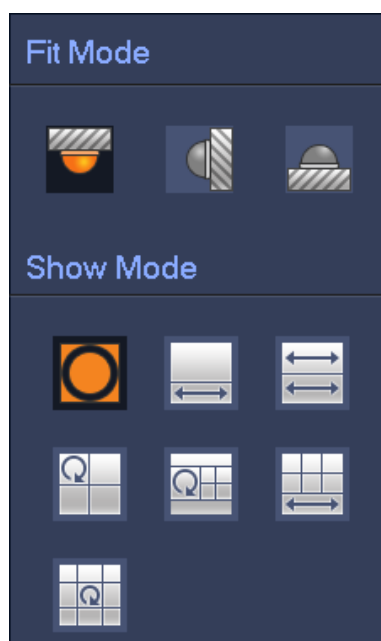

















Table 9-1 Parameters of fisheye

Fit Mode	Icon	Description
Ceilling mount () Ground mount ()		360° panorama original window
		1 dewarp window and 1 panorama expanded window
		2 panorama expanded window
		1 360° panorama window and 3 dewarp windows
		1 360° panorama window and 4 dewarp windows
		4 dewarp windows and 1 panorama expanded window
		1 360° panorama window and 8 dewarp windows
Wall mount ()		360° panorama original window
		Panorama expanded window
		1 panorama unfolding window and 3 dewarp windows
		1 panorama unfolding window and 4 dewarp windows
		1 panorama unfolding window and 8 dewarp windows



- The dewarp modes might vary for different installation modes.
- For the non-fisheye channel, a prompt is displayed to remind you that dewarp function is not supported.
- Some series products support 180° dewarp which can only be wall mounted. The actual product shall prevail.

Figure 9-2 Fisheye show mode





You can use the mouse to drag the color areas on the left original screen or the rectangular screens on the right to change the monitoring ranges. (Not supported for wall mount.)

9.2 Fisheye Dewarp During Playback

When playing back the fisheye recorded video, you can use dewarp function to adjust video.

Step 1 On the XVR main menu, click **SEARCH**.

Step 2 Select 1-window playback mode and corresponding fisheye channel, and then click  to play.

Step 3 Right-click  to go to the dewarp playback interface.

10 FAQ

10.1 PoC Power Supply

PoC XVR supports PoC function.

PoC camera can be divided into AT camera and AF camera. Power consumption of AT camera is less than 12W, and power consumption of AF camera is less than 6W.

You need to check the maximum power of PoC before use. Assuming that the maximum power of one XVR is 48W, the XVR can connect AT cameras up to $48/12=4$ and AF cameras up to $48/6=8$.

When the device is in the condition of PoC power supply, do not connect any other device between the device and PoC XVR or PoC transceiver such as UTC, Balun, optical transceiver, distributor and convertor and so on; otherwise, the device might get burned.

PoC power supply is with high voltage. Do not dismantle the device during normal operation; otherwise it might cause danger to both device and users due to high voltage.

10.2 Long Distance Power Supply

In many scenarios, our clients adopt long distance power supply, transmitting 12V DC to cameras located over 100 m. Such long distance power supply might cause problems.

Q1: Recurrent restart of devices or even ICR Failure.

Possible reasons: The long power supply cable leads to a large voltage drop on the equipment power supply cable, and turning on the IR light at night leads to a further increase of the voltage drop, resulting in restart of the device. After the device is restarted, the ICR is switched to the Day mode by default. By judging the ambient light at night, the device will operate in Night mode, and then the infrared light is turned on, which causes the device to restart again because of undervoltage. Thus, ICR is switched to every 2 seconds, impacting its switching lifespan.

Q2: Unable to restart devices at night, and black screen or restart occurs when switching ICR.

Possible reasons: The long power supply cable leads to a large voltage drop on the equipment power supply cable, and turning on the IR light at night leads to a further increase of the voltage drop, resulting in restart of the device and black screen.

Solution: During construction, when the camera location is far from the power supply, you need to adopt long distance separate power supply or purchase –DP dual power supply to use 24V AC power supply.

10.3 Centralized Power Supply

The typical problem of centralized power supply is that there are obvious black stripes on the device screen, which interferes with the display.

The principle of centralized power supply is as follows:

Figure 10-1 Principle of centralized power supply

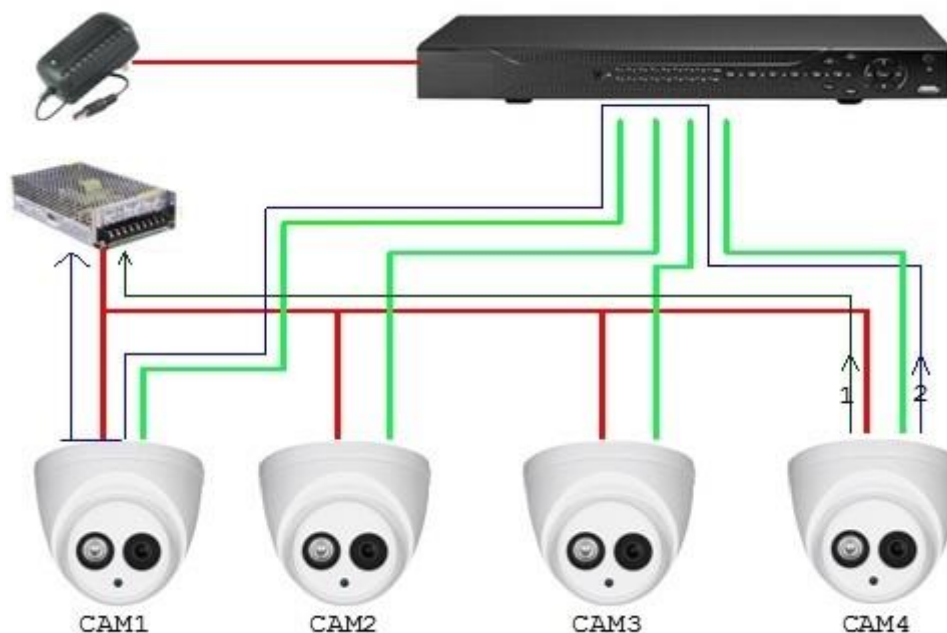

There are two paths for the power output of CAM4, return path 1 and return path 2. Return path 1 first flows to CAM1, and then flows to the power supply from power supply ground of CAM1. In this way, the reflow of power supply ground CAM4 affects the video ground of CAM1, resulting in interference stripes on the screen. And CAM4 also interferes with CAM2 and CAM3.

In the same way, CAM1, CAM2 or CAM3 affects other cameras besides itself.

The main reason for the interference of centralized power supply is that the power supply ground of camera is not isolated. To solve this problem: Use dual-power devices with isolation of power supply ground; equip low-power devices with power isolators to block the return path 2; low-power devices can also use power isolators to block the return path 2; use isolated power supplies for each channel, or power the device separately, which are the two recommended methods.

10.4 Connector Waterproof Protection

HDCVI cameras need to be well waterproofed and protected. After installation, wrap the BNC connector and power connector tightly with insulated or waterproofed tape to prevent water and external electromotive forces. When metal casing device is installed on metal surfaces such as elevators and buses, the metal casing should not be in contact with the installation surface to prevent water and external electromotive forces.

Figure 10-2 Waterproof measures

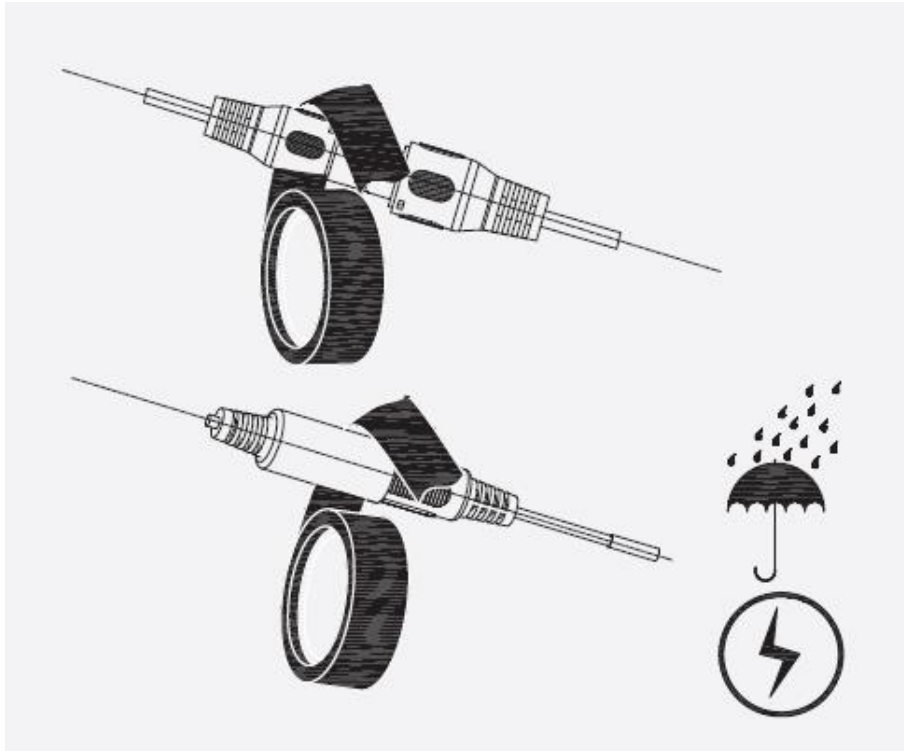

11 Maintenance



In order to maintain the image quality and proper functioning of the device, please read the following maintenance instructions carefully and hold rigid adherence.

Disassembly and Desiccant Replacement

- Carefully follow the instructions in the manual when performing any disassembly operation about the device; otherwise, it might cause water leakage or poor image quality due to unprofessional disassemble.
- Please contact after-sale service for desiccant replacement if there is condensed fog found on the lens after unpacking or when the desiccant turns green. (Not all models are included with the desiccant).

Maintaining Lens and Lens Protector

- The lens and lens protector are covered with antireflection coating, which could be contaminated or damaged and result in lens scratches or haze images when being touched with dust, grease, fingerprints and other similar substances.
- Do not touch the image sensor (CCD or CMOS) directly. Dust and dirt could be removed with air blower, or you can wipe the lens gently with soft cloth that moistened with alcohol.

Maintaining Device Body

- Device body can be cleaned with soft dry cloth, which can also be used to remove stubborn stains when moistened with mild detergent.
- To avoid possible damage on device body coating which could cause performance decrease, do not use volatile solvent such as alcohol, benzene, diluent and so on to clean the device body, nor can strong, abrasive detergent be used.