

# **Network Video Decoder Quick Start Guide**

**V 3.7.0**

# Table of Contents

<b>1</b>	<b>FRONT PANEL/REAR PANEL/INSTALLATION.....</b>	<b>1</b>
1.1	Check Unpacked Device.....	1
1.2	Front panel .....	1
1.2.1	1/4-channel 4K High Definition&1-channel 4K (H.265) high definition series .....	1
1.2.2	9-channel 4K high definition (with 4 input ports) series / 9-channel 4K high definition series /9-channel High Definition Series/16-channel High Definition Series.....	2
1.2.3	12-channel 4K high definition series/12-channel 4K high definition (with 4 input ports) series/ 15-channel 4K high definition series/15-channel 4K high definition (with 4 input ports) series/ 18-channel 4K high definition series/18-channel 4K high definition (with 4 input ports) series/ 21-channel 4K high definition series/21-channel 4K high definition (with 4 input ports) series.....	3
1.3	Rear Panel.....	4
1.3.1	1-channel 4K High Definition Series//1-channel 4K (H.265) high definition series...	4
1.3.2	4-channel 4K high definition series .....	5
1.3.3	9-channel 4K high definition (with 4 input ports) series .....	5
1.3.4	9-channel 4K high definition series .....	6
1.3.5	9-channel High Definition Series .....	7
1.3.6	16-channel High Definition Series .....	7
1.3.7	12-channel 4K high definition series/12-channel 4K high definition (with 4 input ports) series/ 15-channel 4K high definition series/15-channel 4K high definition (with 4 input ports) series/ 18-channel 4K high definition series/18-channel 4K high definition (with 4 input ports) series/ 21-channel 4K high definition series/21-channel 4K high definition (with 4 input ports) series.....	8
1.4	Connection .....	11
<b>2</b>	<b>OPERATION.....</b>	<b>12</b>
2.1	Boot up.....	12
2.2	Shut down.....	12

**2.3 Network Connection.....12**

**2.4 Login.....12**

- 2.4.1 4-channel high definition series/16-channel high definition series/1-channel 4K high definition series/1-channel 4K(H.265) high definition series/4-channel 4K high definition series/12-channel 4K high definition series/12-channel 4K high definition (with 4 input ports) series/15-channel 4K high definition series/15-channel 4K high definition (with 4 input ports) series/18-channel 4K high definition series/18-channel 4K high definition (with 4 input ports) series/21-channel 4K high definition series/21-channel 4K high definition (with 4 input ports) series 13
- 2.4.2 9-channel 4K high definition series/9-channel 4K high definition (with 4 input ports) series 16

## **Welcome**

Thank you for purchasing our product!

This quick start guide will help you become familiar with our device in a very short time.

Before installation and operation please read the following safeguard and warning carefully!

Please keep it well for future reference !

## Important Safeguard and Warning

### 1 . Electrical safety

- All installation and operation here should conform to your local electrical safety codes.
- The product must be grounded to reduce the risk of electric shock.
- We assume no liability or responsibility for all the fires or electrical shock caused by improper handling or installation.
- Please use three-pin power socket (with GND).
- This device is to be connected only to the unit whose power feeding meets the requirements for SELV (Safety Extra Low Voltage) and complies with Limited Power Source according to IEC 60950-1.
- We are not liable for any problems caused by unauthorized modifications or attempted repair.

### 2 . Installation

- Do not apply power to the device before completing installation.
- Do not put object on the device.
- All the examination and repair work should be done by the qualified service engineers.

### 3 . Environment

- This series device should be installed in a cool, dry place away from direct sunlight, inflammable, explosive substances and etc.
- Please guarantee sound ventilation and keep device clean.

### 4. Accessories









- Be sure to use all the accessories recommended by manufacturer.
- Before installation, please open the package and check all the components are included.
- Contact your local retailer ASAP if something is broken in your package.



DANGER

**RISK OF EXPLOSION IF BATTERY IS REPLACED BY AN INCORRECT TYPE.  
DISPOSE OF USED BATTERIES ACCORDING TO THE INSTRUCTIONS.**

## Safety Instruction

Icon	Note
 DANGER	Indicates a hazard with a high level of risk, which if not avoided, will result in death or serious injury.
 WARNING	Indicates a hazard with a middle or low level of risk, which if not avoided, could result in personnel slightly or middle injury.
 CAUTION	Indicates a potentially hazardous situation, which if not avoided, could result in device damage, data loss, performance degradation, or unexpected results.
 Anti-static	Indicates it is the static sensitive device.
 Electric shock risk	Indicates presence of dangerous high voltage. There is a risk of electric shock to persons.
 High power laser radiation risk	Indicates presence of high power laser radiation.
 <b>Tips</b>	It is intended to help you to fix a problem or save your time.
 <b>Note</b>	Provides additional information to emphasize or supplement important points of the main text.

# 1 Front Panel/Rear Panel/Installation



## Note

- All the installation and operations here should conform to your local electric safety rules.
- VGA cable quality and length can affect the video quality. It may result in distorted video, noise, black margin. The video quality may vary even if you are viewing the same video via different VGA cables.

## 1.1 Check Unpacked Device

When you received the device from the shipping agency, please check whether there is any visible damage. The protective materials used for the package of the device can protect most accidental clashes during transportation. Then you can open the box to check the accessories.

Please check the items in accordance with the list.

Finally you can remove the protective film of the device.

The label at the bottom of the box is very important. Usually we need you to present the serial number when we provide the service after sales.

## 1.2 Front panel

### 1.2.1 1/4-channel 4K High Definition&1-channel 4K (H.265) high definition series





The front panel is shown as in Figure 1-1.



Figure 1-1

Please refer to the following sheet for detailed information.

Name	Icon	Function
Power button		Press it for three seconds to boot up or shut down the device. Press it three times within one second, it can clear device configuration.
Power indicator light		The indicator light becomes on when system boots up.
Network indicator light		The indicator light becomes on when abnormal network event occurs (offline, IP conflict and etc.)
USB port		Connect to external USB device.

Name	Icon	Function
Alarm indicator light		The light becomes on when there is an alarm.
HDD indicator light		N/A
IR receiver		N/A
Output indicator light		It is to display output port working mode. <ul style="list-style-type: none"> <li>● For 1-channel 4K high definition series, only the first indicator light are effective.</li> <li>● For 4-channel 4K high definition series and 4-channel high definition series, only the channel 1 to channel 4 indicator lights are effective.</li> </ul>

### 1.2.2 9-channel 4K high definition (with 4 input ports) series / 9-channel 4K high definition series /9-channel High Definition Series/16-channel High Definition Series

The 9-channel 4K high definition (with 4 input ports) series /9-channel 4K high definition series /9-channel high definition series front panel is shown as in Figure 1-2.



Figure 1-2

The 16-channel high definition series front panel is shown as in Figure 1-3.







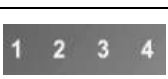

Figure 1-3

Please refer to the following sheet for detailed information.

Name	Icon	Function
Power button		Press it for three seconds to boot up or shut down the device. Press it three times within one second, it can clear



Name	Icon	Function
		device configuration.
Power indicator light		The indicator light becomes on when system boots up.
Network indicator light		The indicator light becomes on when abnormal network event occurs (offline, IP conflict and etc.)
USB port		Connect to external USB device.
Alarm indicator light		The light becomes on when there is an alarm.
HDD indicator light		N/A
IR receiver		N/A
Output indicator light		<p>It is to display output port working mode.</p> <ul style="list-style-type: none"> <li>For 9-channel 4K high definition series/ 9-channel 4K high definition (with 4 input ports) series/9-channel high definition series, only the channel 1 to channel 9 indicator light is effective.</li> <li>For 16-channel high definition series, only the channel 1 to channel 16 indicator light is effective.</li> </ul>

### 1.2.3 12-channel 4K high definition series/12-channel 4K high definition (with 4 input ports) series/ 15-channel 4K high definition series/15-channel 4K high definition (with 4 input ports) series/ 18-channel 4K high definition series/18-channel 4K high definition (with 4 input ports) series/ 21-channel 4K high definition series/21-channel 4K high definition (with 4 input ports) series

The front panel is shown as below. See Figure 1-4.

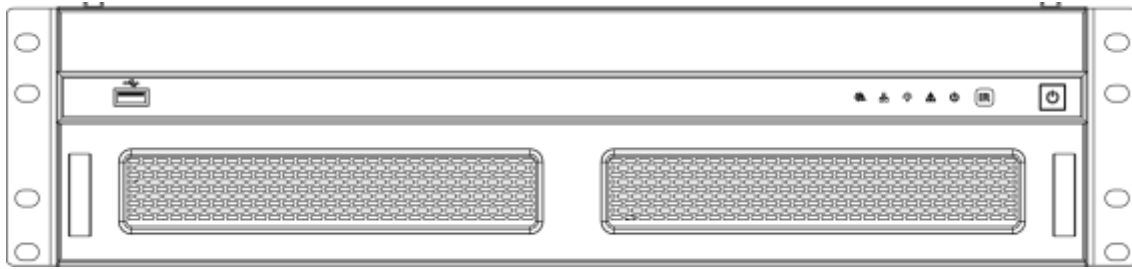









Figure 1-4

Please refer to the following sheet for detailed information.

Name	Icon	Function
Power button		Press it for three seconds to boot up or shut down the device.
IR receiver		N/A
Power indicator light		The indicator light becomes on when system boots up.
Alarm indicator light		The light becomes on when there is an alarm.
Running indicator light		The light is on when device is running.
Network indicator light		N/A
Fan indicator light		N/A
USB port		Connect to external USB device.

### 1.3 Rear Panel

#### 1.3.1 1-channel 4K High Definition Series//1-channel 4K (H.265) high definition series

The rear panel is shown as below. See Figure 1-5.

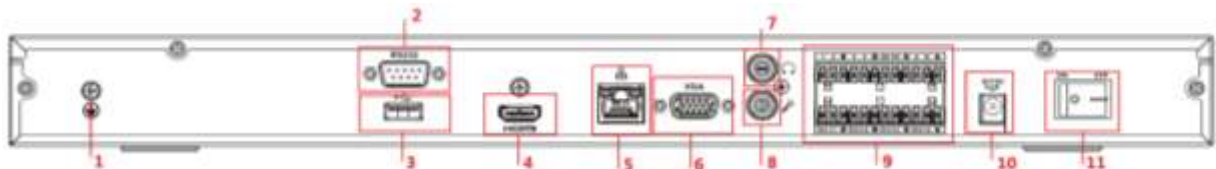

Figure 1-5

Please refer to the following sheet for detailed information.

SN	Port Name	SN	Port Name	SN	Port Name
1	Ground screw hole	2	RS232 port	3	USB port
4	HDMI port	5	Network interface(10M/100M/1000M self-adaptive Ethernet port)	6	VGA port
7	Audio talk output port RCA OUT	8	Audio talk input port RCA IN	9	4-channel alarm input, 4-channel alarm output, RS485 port.
10	Power socket	11	Power switch	-	-

### 1.3.2 4-channel 4K high definition series

The rear panel is shown as below. See Figure 1-6.

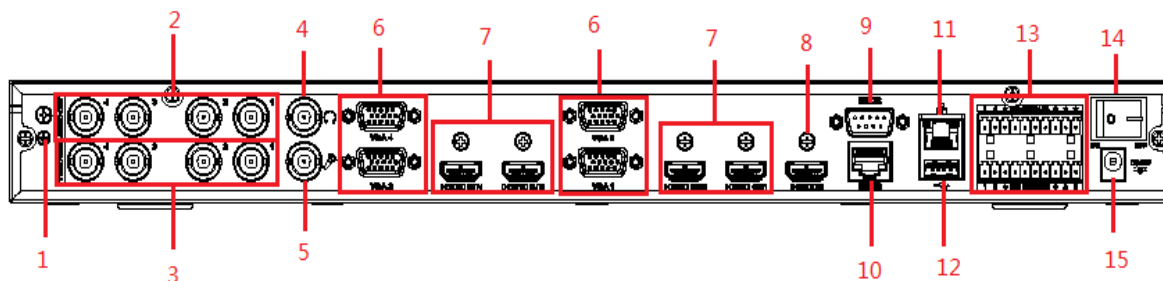

Figure 1-6

Please refer to the following sheet for detailed information.

SN	Port Name	SN	Port Name	SN	Port Name
1	Ground screw hole	2	Audio output port(BNC)	3	Video output port (BNC)
4	Audio talk input port	5	Audio talk output port	6	VGA port
7	HDMI output port	8	HDMI input port	9	RS232 port
10	RS232 port to control the screen	11	Network interface(10M/100M/1000 M self-adaptive Ethernet port)	12	USB port
13	Alarm input, alarm output, standard RS485 port	14	Power on-off button	15	Power socket

### 1.3.3 9-channel 4K high definition (with 4 input ports) series

The rear panel is shown as below. See Figure 1-7.

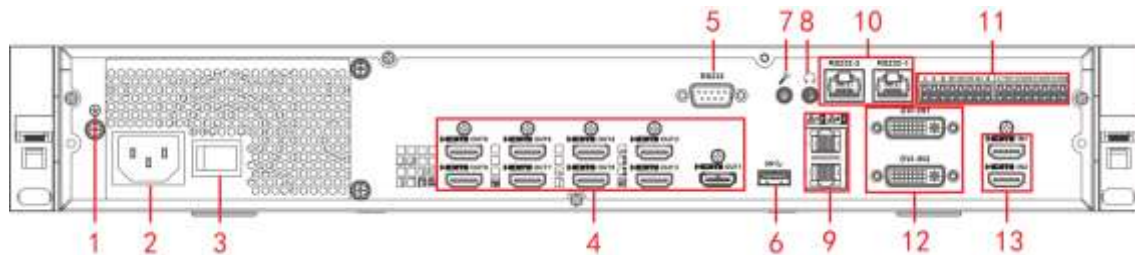

Figure 1-7

Please refer to the following sheet for detailed information.

SN	Port Name	SN	Port Name	SN	Port Name
1	Ground screw hole	2	Power socket	3	Power on-off button
4	HDMI output port	5	RS232 port	6	USB3.0 port
7	Audio talk input port	8	Audio talk output port	9	Network interface(10M/100M /1000M self-adaptive Ethernet port)
10	RS232 port to control the screen	11	Alarm input, alarm output, standard RS485 port	12	DVI-I input port
13	HDMI input port	-	-	-	-

### 1.3.4 9-channel 4K high definition series

The rear panel is shown as below. See Figure 1-8.

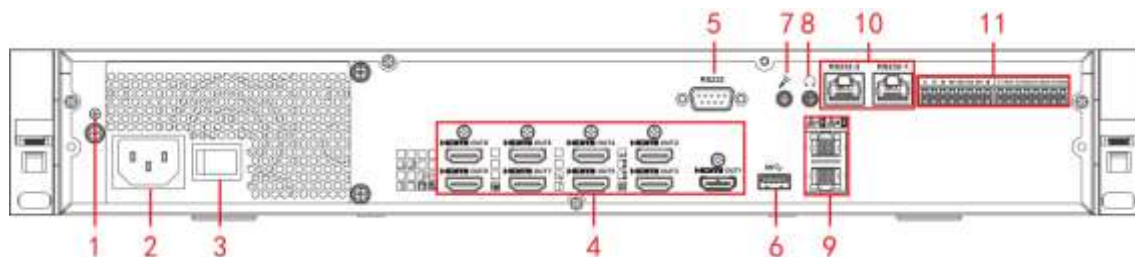

Figure 1-8

Please refer to the following sheet for detailed information.

SN	Port Name	SN	Port Name	SN	Port Name
1	Ground screw hole	2	Power socket	3	Power on-off button
4	HDMI input port	5	RS232 port	6	USB3.0 port
7	Audio talk input port	8	Audio talk output port	9	Network interface(10M/100M/1000M self-adaptive Ethernet port)

SN	Port Name	SN	Port Name	SN	Port Name
10	RS232 port to control the screen	11	Alarm input, alarm output, standard RS485 port	-	-

### 1.3.5 9-channel High Definition Series

The rear panel is shown as below. See Figure 1-9.

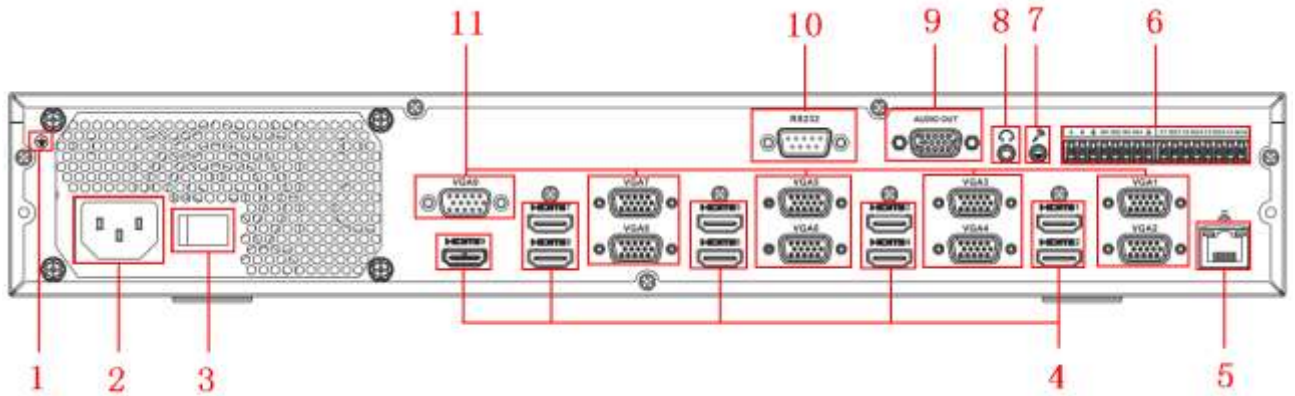

Figure 1-9

Please refer to the following sheet for detailed information.

SN	Port Name	SN	Port Name	SN	Port Name
1	Ground screw hole	2	Power switch	3	Power socket
4	HDMI port	5	Network interface(10M/100M/1000M self-adaptive Ethernet port)	6	Relay input, relay output, standard RS485 port.
7	Audio talk input port	8	Audio talk output port	9	Audio output port
10	RS232 port	11	VGA port	-	-

### 1.3.6 16-channel High Definition Series

The rear panel is shown as below. See Figure 1-10.

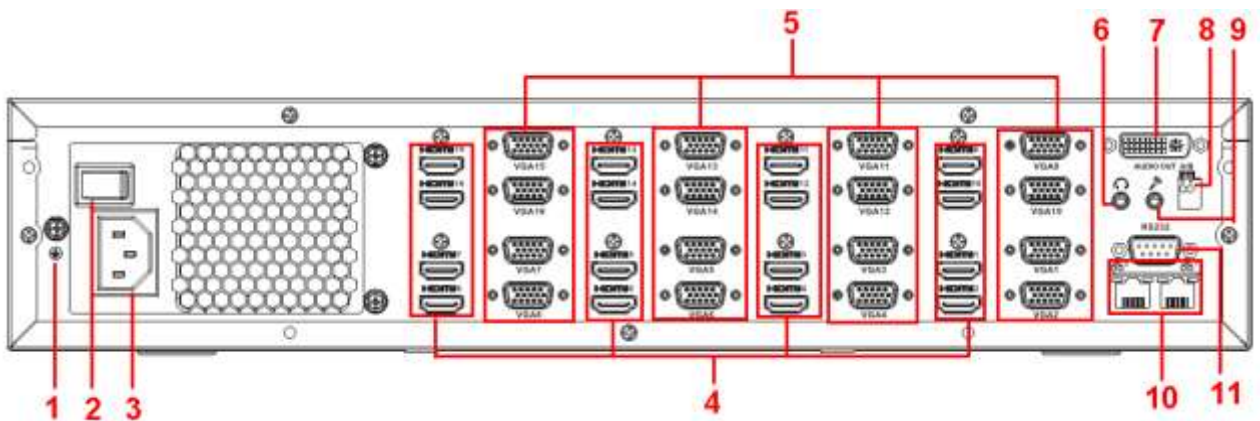

Figure 1-10

Please refer to the following sheet for detailed information.

SN	Port Name	SN	Port Name	SN	Port Name
1	Ground screw hole	2	Power switch	3	Power socket
4	HDMI port (16)	5	VGA port (16)	6	Audio talk output port
7	Audio output port	8	Standard RS485 port	9	Audio talk input port
10	Network interface(10M/100M/1000M self-adaptive Ethernet port)	11	RS232 port	-	-

**1.3.7 12-channel 4K high definition series/12-channel 4K high definition (with 4 input ports) series/ 15-channel 4K high definition series/15-channel 4K high definition (with 4 input ports) series/ 18-channel 4K high definition series/18-channel 4K high definition (with 4 input ports) series/ 21-channel 4K high definition series/21-channel 4K high definition (with 4 input ports) series**

The 21-channel 4K high definition series/21-channel 4K high definition (with 4 input ports) series rear panel is shown as below. See Figure 1-11.

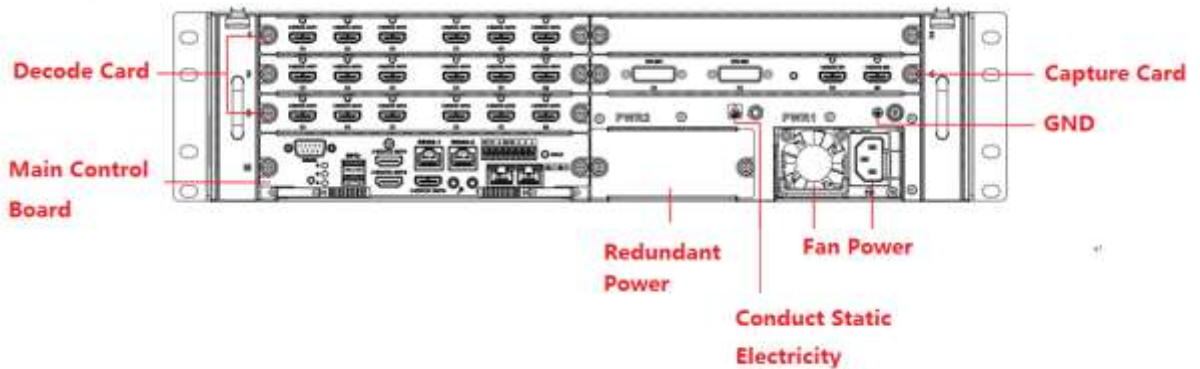

Figure 1-11

The 18-channel 4K high definition series/18-channel 4K high definition (with 4 input ports) series rear panel is shown as below. See Figure 1-12.

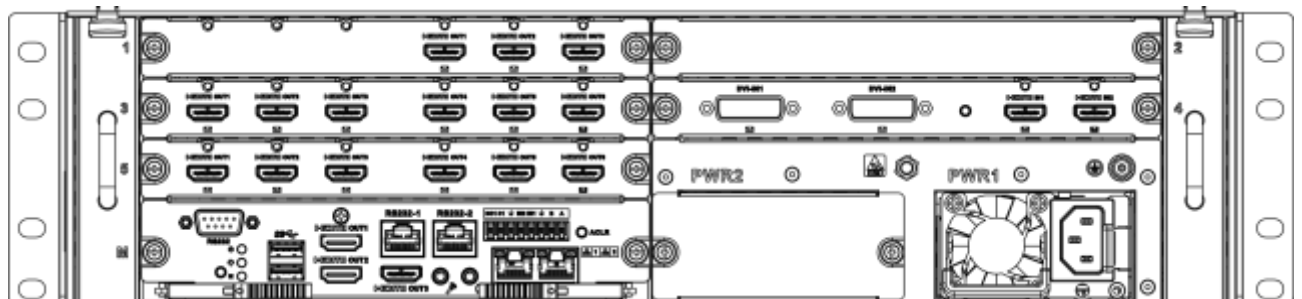

Figure 1-12

The 15-channel 4K high definition series/15-channel 4K high definition (with 4 input ports) series rear panel is shown as below. See Figure 1-13.



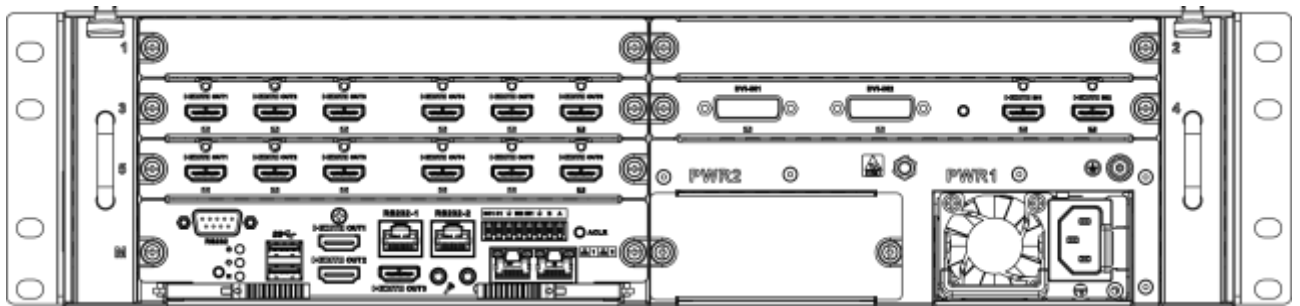

Figure 1-13

The 12-channel 4K high definition series/12-channel 4K high definition (with 4 input ports) series rear panel is shown as below. See Figure 1-14.

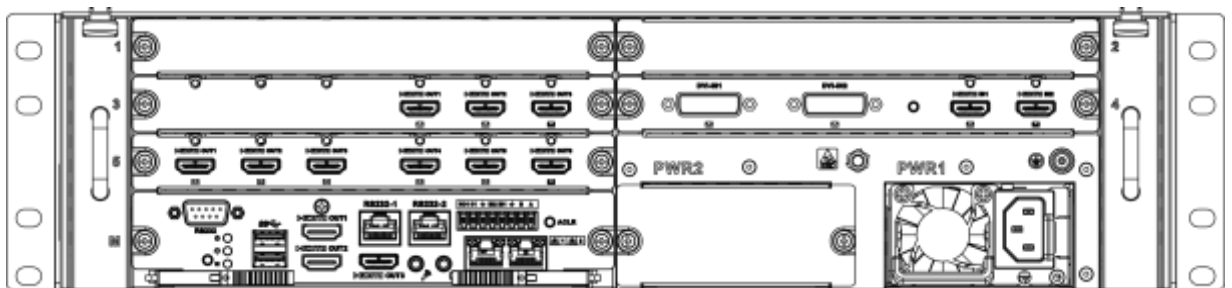

Figure 1-14



**Note**

- For the above four series, they only have different decode card types. The rest parts are the same.
- For XX-channel 4K high definition series and XX-channel 4K high definition (with 4 input ports) series, the only difference is one series has the capture card and the other does not have capture card. The rest parts are the same.

**Main control board**

The control board interface is shown as below. See Figure 1-15.

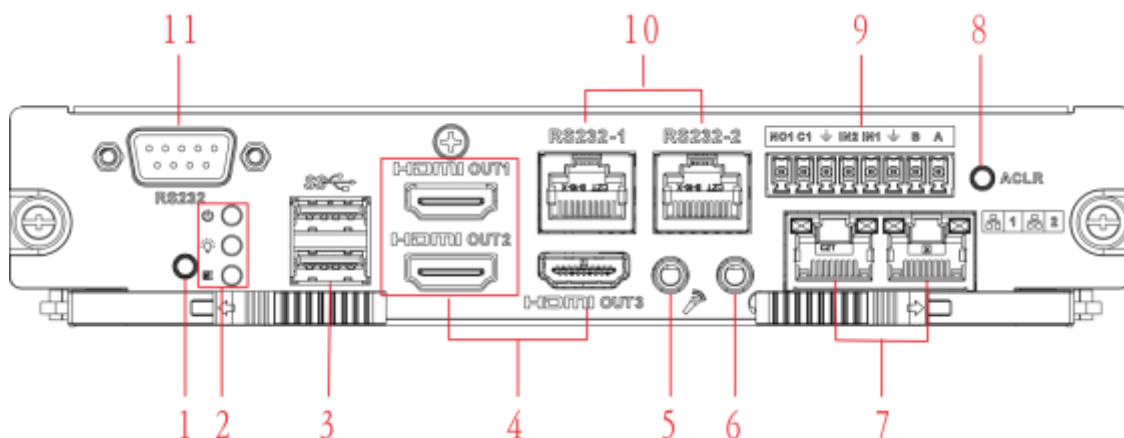

Figure 1-15

Please refer to the following sheet for detailed information.

SN	Name	SN	Name	SN	Name
1	Default button	2	<ul style="list-style-type: none"> <li>● Main control board power indicator light,</li> <li>● system status indicator light,</li> <li>● PCI-E status indicator light</li> </ul>	3	USB port
4	HDMI output port	5	Audio talk input port	6	Audio talk output port
7	Network port	8	Clear alarm button	9	<ul style="list-style-type: none"> <li>● 2-channel alarm input, 1-channel alarm output ,</li> <li>● RS485 port.</li> </ul>
10	RJ45 COM port	11	RS232 COM port	-	-

**Decode card**

The 3-channel decode card is shown as in Figure 1-16.

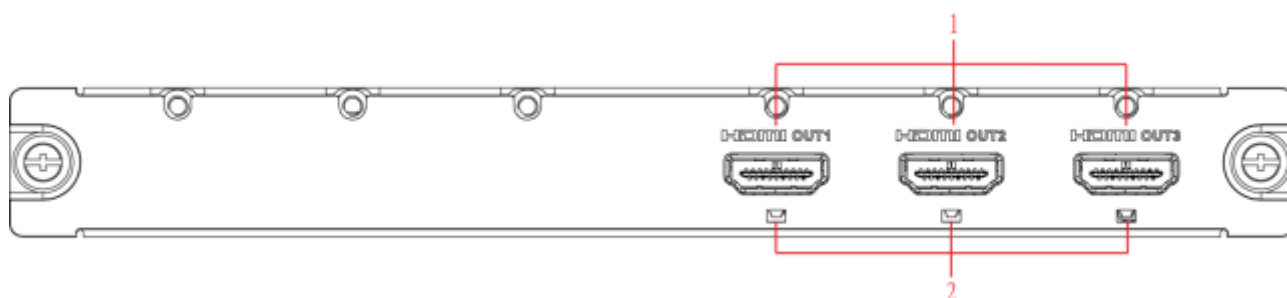

Figure 1-16

The 6-channel decode card is shown as in Figure 1-17.

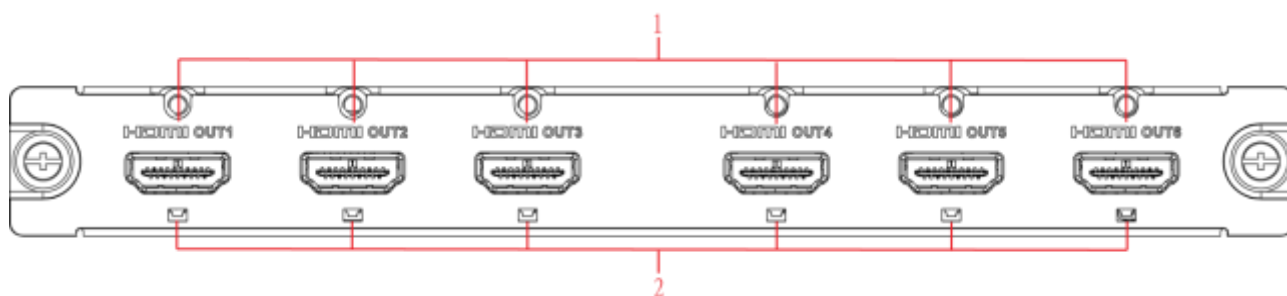

Figure 1-17

Please refer to the following sheet for detailed information.

SN	Port Name	SN	Port Name	SN	Port Name
1	HDMI output port	2	Indicator light	-	-

**Capture card**

The capture card is shown as in Figure 1-18.



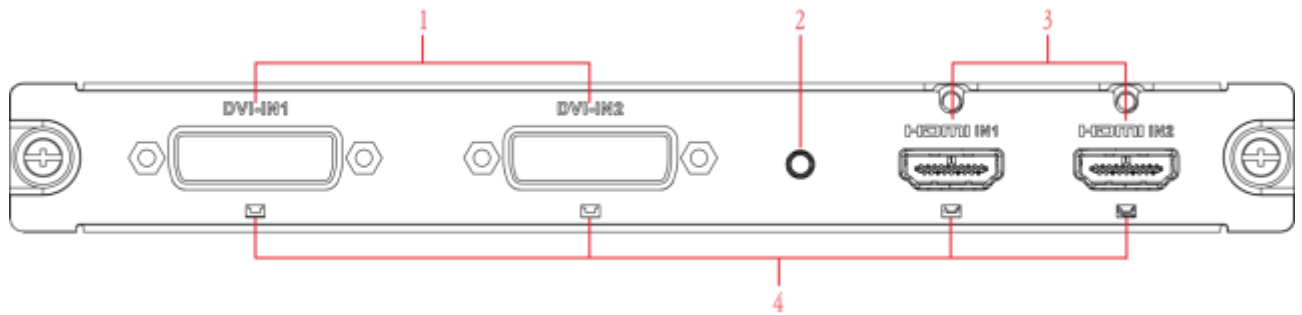

Figure 1-18

Please refer to the following sheet for detailed information.

SN	Name	SN	Name	SN	Name
1	DVI input port	2	Backup button	3	HDMI input port
4	Indicator light	-	-	-	-

**Note**

When you connect it to the PC network port, please use crossover cable.

When you connect it to the PC via router or switcher, please use straight cable.

### 1.4 Connection

Please refer to the follow figure for connection information. See Figure 1-19.

The following figure is based on the 4-channel 4K high definition series product.

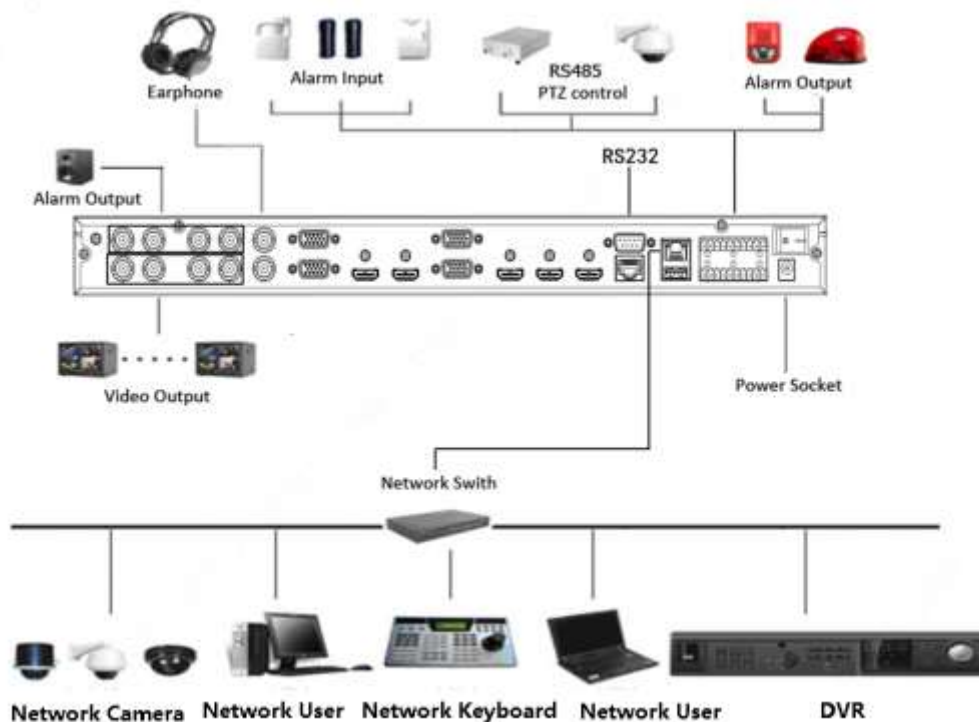

Figure 1-19

## 2 Operation

### Note

- The following operations are generally based on the 9-channel high definition series product.
- Slight different may be found in the user interface.

### 2.1 Boot up

Connect the device to the power and then press the power button in the rear panel. You can see the power indicator light becomes on and device boots up.

The system is in multiple-window display mode by default.

### 2.2 Shut down

You can press power button in the front panel for three seconds to shut down the device.

### Note

When decoder is working, if the power failure occurs, the system can automatically connect to the front-end device and restore previous working status once the power connection becomes normal.

### 2.3 Network Connection

Step 1 Use network cable to connect the Ethernet port of the device and the PC NIC port together. Make sure the device connection is OK.

Step 2 Set PC and device in the same IP segment.

### Note

Device default IP address is 192.168.1.108.

Step 3 Use order ping `***.***.***.***`(Device IP address) to check connection is OK or not. Usually the return TTL value should be less than 64.

Step 4 Open Internet Explorer and then input the address in the column. Click **【Enter】** button.

### Note

WEB control can be downloaded and installed automatically. System can download the latest Web control and remove the old one.

After login the WEB interface, please change device IP address according to the actual situation. Refer to user's manual for detailed information.

Step 5 Connect the device to the network.

### 2.4 Login

### Note

Different series products have different login modes.

**2.4.1 4-channel high definition series/16-channel high definition series/1-channel 4K high definition series/1-channel 4K(H.265) high definition series/4-channel 4K high definition series/12-channel 4K high definition series/12-channel 4K high definition (with 4 input ports) series/15-channel 4K high definition series/15-channel 4K high definition (with 4 input ports) series/18-channel 4K high definition series/18-channel 4K high definition (with 4 input ports) series/21-channel 4K high definition series/21-channel 4K high definition (with 4 input ports) series**

- Step 1 Open the Internet Explorer and then input the device IP address in the address column, click **【Enter】** button.
- Step 2 Device pops up Install plug-in interface. Please click OK and follow the prompts to install the plug-in. If you can't download the plug-in file, please modify your Internet Explorer security setup. After installation, the interface is shown as below. See Figure 2-1.



Figure 2-1

- Step 3 Please input your user name and password and then click Login button.

 **Note**

Default factory name is **admin** and password is **admin**.

Device pops up Modify Password dialogue box. See Figure 2-2.



Figure 2-2

- Step 4 Please input the new password twice and then click the Yes button.

 **Note**

The password ranges from 8 to 32 digitals. It can contain letters, numbers and special characters (excluding “'”, “””, “;”, “.””, “&”). The password shall contain at least two categories. Usually we recommend the strong password.



**WARNING**

**STRONG PASSWORD RECOMMENDED-For your device own safety, please create a strong password of your own choosing. We also recommend you change your password periodically especially in the high security system.**

Step 5 After successfully set the new password, system asks you to login again. Please input the user name admin and new password to login.

 **Note**

- Different series products have different login interfaces. Please refer to the actual interface for detailed information.
- For 9-channel high definition series/16-channel high definition series/1-channel 4K high definition series/1-channel 4K (H.265) high definition series, the interface is shown as in Figure 2-3. For 12-channel 4K high definition series/12-channel 4K high definition (with 4 input ports) series/15-channel 4K high definition series/15-channel 4K high definition (with 4 input ports) series/ 18-channel 4K high definition series/18-channel 4K high definition (with 4 input ports) series/ 21-channel 4K high definition series/21-channel 4K high definition (with 4 input ports) series, the interface is shown as Figure 2-4. For 4-channel 4K high definition series, the interface is shown as below. See Figure 2-5.

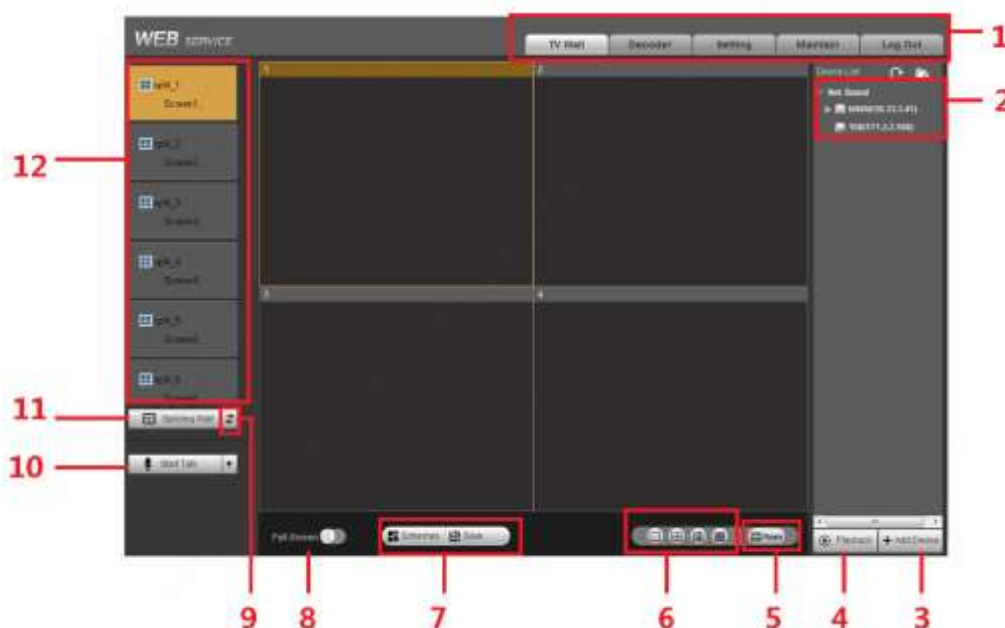

Figure 2-3

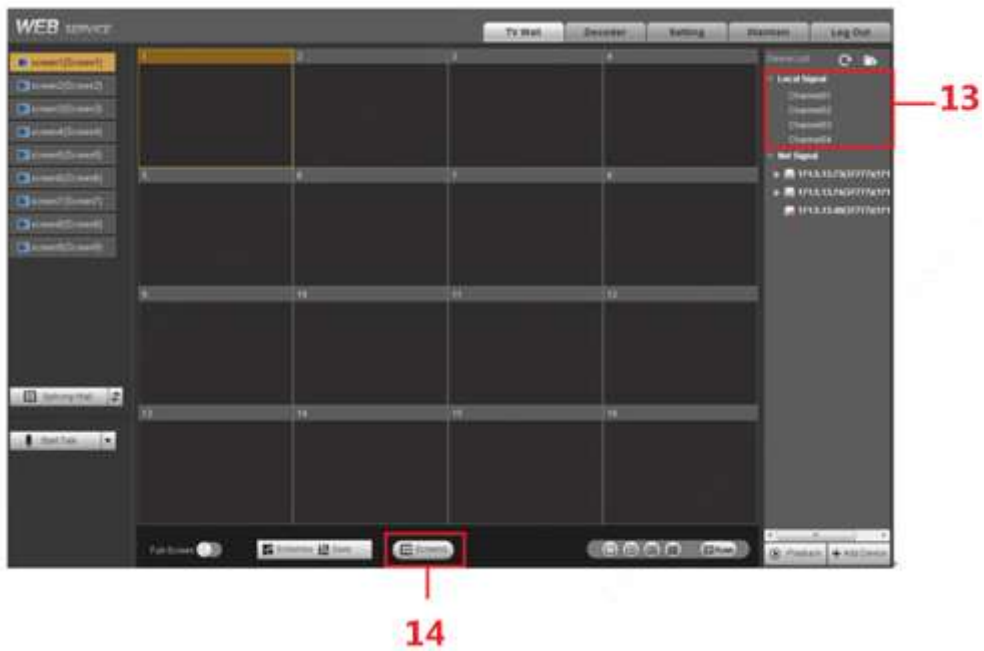

Figure 2-4

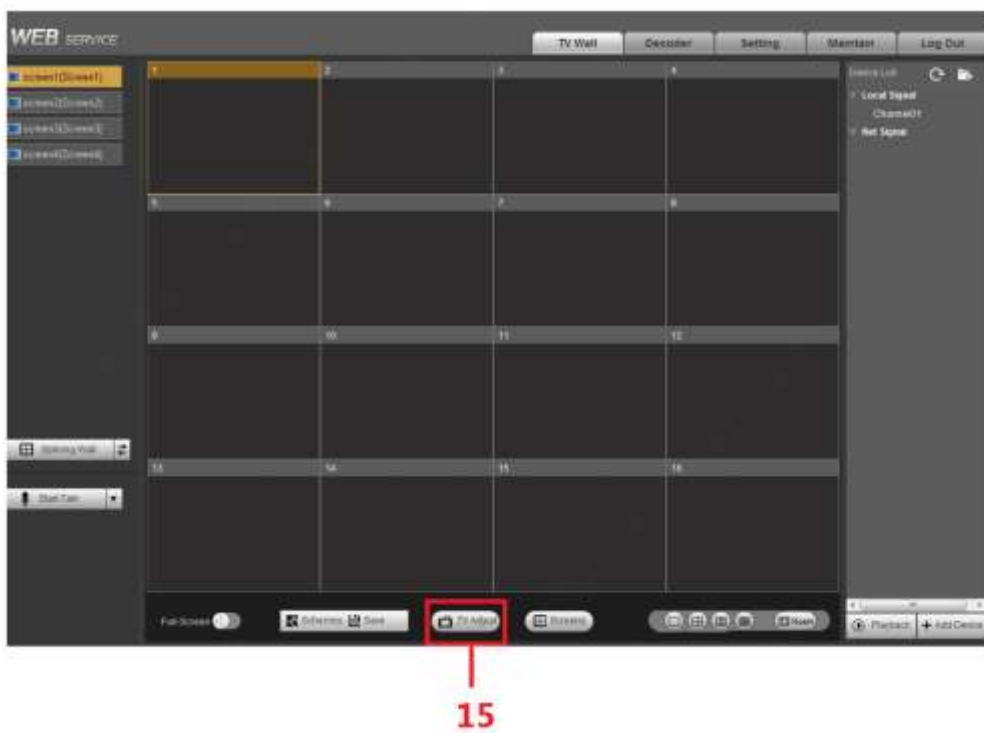

Figure 2-5

Please refer to the following sheet for detailed information.

SN	Name	SN	Name
1	System menu	2	Network signal
3	Add/delete device	4	Playback
5	Roam	6	Window split

SN	Name	SN	Name
7	Scheme manager/Save	8	Full-screen button
9	Refresh	10	Bidirectional talk
11	Splicing wall	12	Screen No.
13	Local signal	14	Screen manager
15	TV adjustment	-	-

#### 2.4.2 9-channel 4K high definition series/9-channel 4K high definition (with 4 input ports) series

Step 1 Open the Internet Explorer and then input IP address on the address column, click **【Enter】** button.

Enter Initialization interface. See Figure 2-6.

Figure 2-6

Step 2 Input password and then confirm, click OK button. See Figure 2-7.

#### Note

The password ranges from 8 to 32 digitals. It can contain letters, numbers and special characters (excluding “'”, “””, “,””, “:”, “&”). The password shall contain at least two categories. Usually we recommend the strong password.



#### WARNING

**STRONG PASSWORD RECOMMENDED**-For your device own safety, please create a strong password of your own choosing. We also recommend you change your password periodically especially in the high security system.

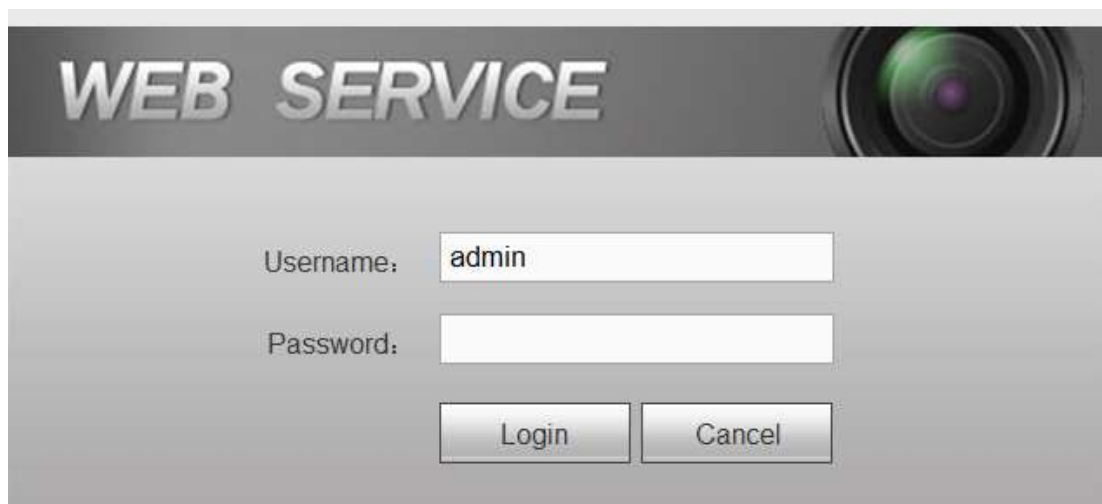

**WEB SERVICE**

Username:

Password:

Login Cancel

Figure 2-7

Step 3 Input the password and then click Login.

 **Note**

System default user name is **admin**.

 **Note**

- For detailed operation introduction, please refer to the User's Manual.
- This quick start guide is for reference only. All the designs and software here are subject to change without prior written notice.
- All trademarks and registered trademarks mentioned are the properties of their respective owners.
- If there is any uncertainty or controversy, please refer to the final explanation of us.
- Please visit our website or contact your local retailer for more information.